

## **COLCHESTER ARCHAEOLOGICAL REPORT 3:**

**Excavations at Lion Walk, Balkerne Lane, and Middleborough,  
Colchester, Essex**

## **Colchester Archaeological Reports**

**Report 1:** *Aspects of Anglo-Saxon and Norman Colchester*

by Philip Crummy (CBA Research Report **39**), 1981  
ISBN 0-906780-06-3

Published jointly by the Colchester Archaeological Trust and the Council for British Archaeology, 112 Kennington Road, London SE 11 6RE

**Report 2:** *The Roman small finds from excavations in Colchester 1971-9*

by Nina Crummy, 1983  
ISBN 0-9503727-3-0



# COLCHESTER ARCHAEOLOGICAL REPORT 3:

Excavations at Lion Walk,  
Balkerne Lane, and Middleborough,  
Colchester, Essex

PHILIP CRUMMY

with contributions from  
Howard Brooks, P M Barford, J Bayley,  
C M Cunningham, Nina Crummy, P J Drury,  
A J Gouldwell, K F Hartley, Dr S Limbrey,  
Dr Roger Ling, Joan Liversidge, Dr R Luff,  
P M Murphy, David S Neal, Dr R Reece, Dr D J Smith  
R P Symonds, Maisie Taylor, and Dr J P Wild

Principal illustrators:  
R H MOYES, L P EDWARDS, AND T W COOK



COLCHESTER ARCHAEOLOGICAL TRUST LTD

© 1984 Colchester Archaeological Trust Ltd and  
Department of the Environment  
Published 1984 by  
Colchester Archaeological Trust Ltd,  
12 Lexden Road,  
Colchester,  
Essex, CO3 3NF.

British Library Cataloguing in Publication Data  
Crummy, Philip

Excavations at Lion Walk, Balcerne Lane, and  
Middleborough, Colchester, Essex. — (Colchester  
Archaeological Reports, ISSN 0264-6013; 3)

1. Colchester (Essex) — Antiquities

2. England — Antiquities

I. Title II. Series

942.6'723 DA690.C7

ISBN 0-9503727-4-9

Computerized typesetting by Kentchase Ltd, 351  
Oxford Avenue, Slough.

Artwork and camera-ready copy prepared by  
Colchester Archaeological Trust Ltd.

Printed by Vineyard Press Ltd, 1 East Stockwell  
Street, Colchester.

#### List of contributors

P M Barford, (lead coffin)  
Greenacre,  
Straight Road,  
Bradfield,  
Essex CO11 2RA

Justine Bayley, (metallurgy)  
Ancients Monuments Laboratory,  
Department of the Environment,  
Fortress House,  
23 Savile Row,  
London W1X 2HE

Howard Brooks, (co-author of the Middleborough site report)  
c/o Colchester Archaeological Trust,  
12 Lexden Road,  
Colchester CO3 3NF

Nina Crummy, (small finds & Roman tiles)  
Colchester Archaeological Trust,  
12 Lexden Road,  
Colchester CO3 3NF

C M Cunningham, (medieval pottery & louvers)  
Chelmsford Archaeological Trust,  
The Old Cemetery Lodge,  
1 Writtle Road,  
Chelmsford CM1 3BL

P J Drury, (medieval tiles & stamped clay fireback)  
Chelmsford Archaeological Trust,  
The Old Cemetery Lodge,  
1 Writtle Road,  
Chelmsford CM1 3BL

A J Gouldwell, (charcoal)  
Department of Archaeology,  
University of Leicester,  
University Road,  
Leicester

K F Hartley, (mortarium stamps)  
Flat A,  
22 Shire Oak Road,  
Leeds LS6 2DE

Dr S Limbrey, (soil sample)  
Department of Ancient History and Archaeology,  
The University of Birmingham,  
P O Box 363,  
Birmingham B15 2TT

The Colchester Archaeological Trust Ltd  
acknowledges with gratitude the grant towards the  
publication of this volume from the Department of the  
Environment.

The principal officers of the Colchester  
Archaeological Trust (formerly the Colchester  
Excavation Committee) since 1971:

*Presidents:* Lord Alport (1965-72),  
Sir Mortimer Wheeler (1972-  
6),  
Professor S S Frere (1976- )  
*Chairmen:* M R Hull (1971),  
Major J G S Brinson (1971-4),  
Dr M S Tite (1974-9),  
F H Thompson (1979-82),  
Professor J J Wilkes (1982- )  
*Honorary Secretaries:* Major J G S Brinson (1964-  
72),  
D T-D Clarke (1972- )  
*Honorary Treasurers:* C S Buck (1969-75),  
I McMaster (1975-80),  
S G Maddison (1980- )  
*Director and General Editor:* Philip Crummy (1971- )

Dr R Ling, (wall plaster)  
History of Art Department,  
University of Manchester,  
Manchester M13 9PL

Joan Liversidge, (Roman bed)  
10 Richmond Road,  
Cambridge CB4 3PU

Dr Rosemary Luff, (animal & human bones)  
c/o Eicon Research,  
Unit 9,  
Viking Way,  
Bar Hill,  
Cambridge

P M Murphy, (environmental material)  
Earlham Hall,  
University of East Anglia,  
Norwich NR4 7TJ

David S Neal, (mosaic)  
Department of the Environment,  
Fortress House,  
23 Savile Row,  
London W1X 2HE

Dr R Reece, (coins)  
Institute of Archaeology,  
31-4 Gordon Square,  
London WC1H 0PY

Dr D J Smith, (mosaics)  
Department of Archaeology,  
The University,  
Newcastle upon Tyne NE1 7RU

Maisie Taylor, (charcoal)  
Sycamore Farm House,  
Sea Dyke Bank,  
Wisbech St Mary,  
Cambridgeshire

Robin Symonds, (Roman pottery)  
Colchester Archaeological Trust,  
12 Lexden Road,  
Colchester CO3 3NF

Dr J P Wild, (textiles)  
Department of Archaeology,  
University of Manchester,  
Manchester M13 9PL

# CONTENTS

Acknowledgements . . . . .	viii	The wall plaster from Building 8 <i>by Roger Ling</i> . . . . .	42
List of illustrations . . . . .	ix	The bed . . . . .	42
Introduction . . . . .	1	The textiles <i>by John Peter Wilde</i> . . . . .	44
<b>Roman and medieval Colchester</b>			
The fortress (Colchester Period 1) . . . . .	3	The ?bed <i>by Joan Liversidge</i> . . . . .	47
The planning of the fortress . . . . .	5	Building 9 . . . . .	47
The pre-Boudican colony (Colchester Period 2) . . . . .	5	Building 10 . . . . .	49
The reuse of fortresses in Britain . . . . .	9	Building 11 . . . . .	49
The reuse of fortresses on the continent . . . . .	10	Building 12 . . . . .	49
The development of the colony from AD 60/1 to c 125 (Colchester Periods 3 & 4) . . . . .	11	Building 13 . . . . .	50
The town wall and rampart (Colchester Periods 5 & 6) . . . . .	14	Buildings 14 and 15 . . . . .	50
The later development of the colony (Colchester Periods 5c & 6) . . . . .	16	Building 16 . . . . .	50
The extent of the colony . . . . .	19	Building 17 . . . . .	52
Building methods . . . . .	20	Building 18 . . . . .	52
Public buildings . . . . .	24	Building 19 . . . . .	52
Private houses . . . . .	25	The mosaic in Room 11/15 <i>by D J Smith</i> . . . . .	57
Ovens, hearths, and kilns . . . . .	25	'The Mosaic of the Lion' <i>by D J Smith</i> . . . . .	57
Cemeteries . . . . .	26	Building 20 . . . . .	62
Water supply . . . . .	26	Building 21 . . . . .	66
Footways . . . . .	28	Building 22 . . . . .	66
The stone architectural fragments <i>by Nina Crummy</i> . . . . .	28	Building 23 . . . . .	68
Anglo-Saxon and Norman Colchester . . . . .	29	Buildings 24 and 25 . . . . .	69
Medieval and later houses . . . . .	29	Building 26 . . . . .	69
The defences of the post-Roman town . . . . .	30	Building 27 . . . . .	70
Lime production . . . . .	30	The end of the Roman buildings . . . . .	70
<b>Excavations at Lion Walk 1971-4</b>			
The fortress . . . . .	31	The Roman town defences . . . . .	70
The military defences . . . . .	31	The Roman streets . . . . .	73
Buildings 1-6 (Period 1) . . . . .	31	The Anglo-Saxon huts . . . . .	73
Building 1 . . . . .	34	Robber trenches and post-Roman pits . . . . .	75
Building 2 . . . . .	34	Building 28 . . . . .	75
Building 3 . . . . .	34	The floor of glazed tiles and a fragment of crested ridge tile <i>by P J Drury</i> . . . . .	81
Building 4 . . . . .	35	Building 29 . . . . .	82
Building 5 . . . . .	35	Building 30 . . . . .	82
Building 6 . . . . .	35	Building 31 . . . . .	82
Building 7 . . . . .	35	Building 32 . . . . .	82
Streets (Period 1) . . . . .	37	Building 33 . . . . .	84
The first civilian occupation (AD 49 to 60/1) . . . . .	37	The medieval bastion and the refacing of the town wall . . . . .	84
Buildings 3-6 (Period 2) . . . . .	37	The eleventh-century ditch . . . . .	84
Carbonised fruits from Building 5 <i>by P Murphy</i> . . . . .	40	Medieval lime production . . . . .	87
Building 8 . . . . .	40	Tap slag at the south end of Lion Walk (c 11th century) . . . . .	91
<b>Excavations at Balkerne Lane 1973-6</b>			
Period 1 (c AD 44 to 50/?55) . . . . . 93			
The earliest remains of Period 1 . . . . . 93			
The legionary ditch . . . . . 93			
The <i>via sagularis</i> . . . . . 94			



Bibliography . . . . .	217
Index . . . . .	221

## Microfiche supplement

Figures relating to the printed text (Figs 3, 58, 71, 123, 130, & 134-5) . . . . .	227
Appendix 1: Human remains from Lion Walk and Balcerne Lane <i>by R Luff</i> . . . . .	232
Appendix 2: Examination of a lead coffin and its contents from Balcerne Lane <i>by P M Barford</i> . . . . .	238
Appendix 3: The stone architectural fragments <i>by Nina Crummy</i> . . . . .	260
Appendix 5: The Roman tiles <i>by Nina Crummy</i> . . . . .	295
Appendix 6: Tables showing the Roman painted wall plaster from Buildings 8, 67, 69, 70, and 71 . . . . .	302
Appendix 8: Descriptions of complete or nearly complete buried pots <i>by R P Symonds and C M Cunningham</i> . . . . .	307
Appendix 9: A green-stained soil sample from a pit at Lion Walk, Site J <i>by S Limbrey</i> . . . . .	319
Appendix 10: Summary of the ceramic dating evidence for some key areas at Lion Walk and Balcerne Lane <i>by R P Symonds</i> . . . . .	320
Appendix 11: Carbonised cereals and crop weeds from Buildings 38, 41, and 45 (Balcerne Lane) <i>by P Murphy</i> . . . . .	341
Appendix 12: Soil monolith through the cultivated soil of Period 5 at Balcerne Lane <i>by P Murphy</i> . . . . .	358
Appendix 13: Summary of the products of the Roman kiln F1019 (Middleborough) <i>by R P Symonds with a contribution by K F Hartley</i> . . . . .	360
Appendix 14: Miscellaneous soil samples (Middleborough) <i>by P Murphy</i> . . . . .	365
Appendix 15: List of significant charcoal samples <i>identified by A J Gouldwell and Maisie Taylor</i> . . . . .	368
Sections 1-112 (except Sxs 43, 54-8, 61-2, 65, 71-2, 75, 98-9)	

## Outsize illustrations

### Sheet 1a

Fig 16 Military remains (Period 1) at Lion Walk (east)  
 Fig 24 Lion Walk Period 2 (east)  
 Fig 36 Lion Walk AD 60/1-c 100 (east)  
 Fig 41 Lion Walk c AD 100-450 (east)

### Sheet 1b

Fig 17 Military remains (Period 1) at Lion Walk (west)  
 Fig 25 Lion Walk Period 2 (west)  
 Fig 37 Lion Walk AD 60/1-c 100 (west)

### Sheet 2a

Fig 29 Southern end of Building 8  
 Fig 60 Lion Walk post-Roman (east)  
 Fig 62 Buildings 28 and 29, Phase 1  
 Fig 67 Buildings 28 and 29, Phases 2 and 3

### Sheet 2b

Fig 42 Lion Walk c AD 100-450 (west)  
 Fig 61 Lion Walk post-Roman (west)

### Sheet 3a

Fig 81 Balcerne Lane Period 1 (east and west)

### Sheet 3b

Fig 91 Balcerne Lane Period 2 (east and west)  
 Fig 101 Balcerne Lane AD 60/1-150 (west)

### Sheet 4a

Fig 93 Buildings 44 and 45 and part of Building 46  
 Fig 98 Balcerne Lane Period 3 (east)  
 Fig 111 Building 51

### Sheet 4b

Fig 100 Balcerne Lane Period 4 (east)  
 Fig 103 Balcerne Lane Period 5 (east)  
 Fig 104 Balcerne Lane AD 150-250 (west)

### Sheet 5a

Fig 106 Balcerne Lane Periods 5c and 6 (east and west)

### Sheet 5b

Fig 151 Building 70 (Middleborough, Period 3)  
 Fig 192 The surviving timber-frame of Building 76

### Sheet 6a

Lion Walk Sxs 54/62/55, Sxs 56/57/58, and Sx 61

### Sheet 6b

Balcerne Lane Sx 65, Sx 71, Sx 72, and Sx 75  
 Middleborough Sx 98 and Sx 99

## Acknowledgements

The subject matter of this report derives from the work of hundreds of people who in total have spent many tens of thousands of hours on the various aspects involved. Vast quantities of soil have been shifted by bands of skilful, hard-working diggers. Their efforts have been matched by much effective labour in the find-sheds often by local people who have given their spare time to help. Over the years, the day-to-day running of the sites has been carried out by about 30 supervisors and planners who between them have filled in dozens of site note books and drawn many hundreds of plans. Away from the sites, activity has been equally intense. Thousands of objects have been conserved and catalogued, countless drawings have been prepared for publication, endless columns in account books have been filled in, and innumerable letters have been written or answered. Also there have been many groups of people in local government, the building industry, architectural practice, business and elsewhere who have helped the excavations either by way of advice or co-operation or in some more tangible fashion. To all concerned I would like to express my warmest thanks and appreciation.

In the context of the excavations described in this report, special mention must be made of the following people. The supervisors, planners, finds assistants and administrative assistants were VBishop, GBlack, HBrooks, MBrummer, KButler, ECampbell, DCreswell, JCreswell, CCrossan, GCrossan, NCrummy, SCrummy, MDaniels, TDavidson, PFroste, AGouldwell, VGrainger, DGurney, AHayes, JHayes, SHilton, JHind, KJarvis, IJenkins, RJohnson, ALockley, RO'Malley, DMann, PMasters,

PMeek, POttaway, ASandford, MSchofield, JSewter, PSewter, DShimmin, MShort, NSmith, DStanding-Smith, GSummers, BWaterhouse, and HWaterhouse. The photographers were AColchester, JLockett, and MWoodfield. Conservation was undertaken by the Colchester and Essex Museum, the conservators being PSweeney and JWhiffing.

The excavations were carried out by the Colchester Excavation Committee (now the Colchester Archaeological Trust) with the aid of grants from the Department of the Environment, the Colchester Borough Council, the Essex County Council, the Pilgrim Trust, the Land and House Property Development Corporation Ltd (Lion Walk), and the Royal London Mutual Insurance Society Ltd (Middleborough). Invaluable assistance on the sites concerned was received from the following contractors: MacAlpines (Lion Walk), Roadworks (Ipswich) Ltd (Balkerne Lane), Fairclough Building Ltd and RMDouglas Construction Ltd (Middleborough). Throughout the period, the Trust enjoyed considerable support from various departments of the Colchester Borough Council especially the Departments of Engineering and Planning, the Treasurer's Department, and of course the Colchester and Essex Museum. The plans and sections in this report were redrawn for publication by R Alley, T Cook, J Dinn, L Edwards, and R Moyes. The index was compiled by Nina Crummy.

Finally I am most grateful to all the specialists for their much appreciated contributions and to Dr H Cleere for his help with the iron-making material. I am especially indebted to Nina Crummy, Mr DT-D Clarke, and Professor J J Wilkes for their comments about the draft of this report.

## LIST OF ILLUSTRATIONS

1	The positions of the Lion Walk, Balkerne Lane, and Middleborough sites	1	42	Lion Walk <i>c</i> AD 100-450 (west)	<i>outsized, Sheet 2b</i>
2	Plan conventions	2	43	Room 2 of Building 19, Phases 1 and 2	55
3	Section conventions	<i>microfiche</i> 227	44	Room 2 of Building 19, Phase 3	56
4	Plans of the fortress (Colchester Period 1) and Colchester (Period 2)	4	45	Room 18 of Building 19	57
5	Comparison of the plans of the fortresses at Colchester and Caerleon	6	46	Painting of mosaic in Room 11/15 of Building 19	58
6	Dimensions of the fortress at Colchester and the structure of its plan	7	47	Painting of mosaic in Room 11/15 of Building 19	59
7	Colchester Periods 3 and 4	12	48	Painting of 'The Mosaic of the Lion'	60
8	Colchester Period 4: probable extent of western extension	13	49	Painting of the lion in 'The Mosaic of the Lion' and the remains <i>in situ</i>	61
9	Colchester Periods 5 and 6	16	50	Building 20, Phase 1, rooms along the street frontage	64
10	Histograms of coins from the Lion Walk, Balkerne Lane, and Middleborough sites	17	51	Building 20, Phase 2, rooms along the street frontage	65
11	Types of wall	21	52	The cellar in Building 22	67
12	Burnt daub-block wall JF420	22	53	The cellar in Building 22	68
13	Pre-Boudican keyed daub from Building 8 at Lion Walk	24	54	Pits associated with Building 23	69
14	Colchester water supply	27	55	Layer of topsoil and broken roof tiles overlying floor of Passage 1 in Building 24	70
15	Lion Walk Period 1: general plan	32	56	Phases in the trench behind the town wall	71
16	Military remains (Period 1) at Lion Walk (east)	<i>outsized, Sheet 1a</i>	57	Flow diagram of phases on Site M	72
17	Military remains (Period 1) at Lion Walk (west)	<i>outsized, Sheet 1b</i>	58	Location of Site U and detailed site plan	<i>microfiche</i> 228
18	Annexe defences	33	59	Lion Walk post-Roman remains: general plan	74
19	Defences of annexe viewed from the north	34	60	Lion Walk post-Roman (east)	<i>outsized, Sheet 2a</i>
20	Slots in Building 5	35	61	Lion Walk post-Roman (except Building 28, Phase 1) (west)	<i>outsized, Sheet 2b</i>
21	Interpretation of Building 7 and Building 8	36	62	Buildings 28 and 29, Phase 1	<i>outsized, Sheet 2a</i>
22	Site L: street between Buildings 1 and 2; Building 11; and Building 12	38	63	The northern wall of the hall block of Building 28	76
23	Lion Walk Period 2: general plan	39	64	East end of Room 1 of Building 28	77
24	Lion Walk Period 2 (east)	<i>outsized, Sheet 1a</i>	65	Features under Room 3 and timber-lined pit (GF234) in the yard of Building 28	78
25	Lion Walk Period 2 (west)	<i>outsized, Sheet 1b</i>	66	Rooms 3b and 6 and spread of broken peg-tile in yard of Building 28	79
26	Burnt dates and plum	40	67	Buildings 28 and 29 (Phases 2 and 3)	<i>outsized, Sheet 2a</i>
27	Burnt daub wall (F312)	41	68	Building 28, Phase 2, from the west	80
28	Wall plaster on wall JF312	41	69	Fragment of crested roof tile	81
29	Southern end of Building 8	<i>outsized, Sheet 2a</i>	70	Post-Roman features under Buildings 28 and 29	83
30	System of drains in Building 8	42	71	Buildings 31 and 32	<i>microfiche</i> 229
31	Flow diagram for alterations to Buildings 7 and 8	43	72	Bastion 8 and Building 33	85
32	Remains of the burnt ?bed	44	73	Lime kiln JF12	86
33	Textiles and rope of ?bed	45	74	Tunnel JF133 in lime kiln JF16	87
34	Weaving draft of the diamond twill	46	75	Lime kilns: general plan	88
35	Lion Walk AD 60/1- <i>c</i> 100: general plan	48	76	Late medieval lime kilns	89
36	Lion Walk AD 60/1- <i>c</i> 100 (east)	<i>outsized, Sheet 1a</i>	77	Lime kilns: Phases 1-5	90
37	Lion Walk AD 60/1- <i>c</i> 100 (west)	<i>outsized, Sheet 1b</i>	78	Lime kilns: some structural details	91
38	Forging hearth (LF267)	49	79	Part of Section 52 illustrating loss of latest Roman levels since the early medieval period	92
39	Building 16, room(s) along the street frontage	51	80	Balkerne Lane Period 1: general plan	94
40	Lion Walk <i>c</i> AD 100-450: general plan	53	81	Balkerne Lane Period 1 (AD 43-50/55) (east and west)	<i>outsized, Sheet 3a</i>
41	Lion Walk <i>c</i> AD 100-450 (east)	<i>outsized, Sheet 1a</i>			

82	Wheel ruts and decayed wattles of Period 1 on the south side of the main street . . .	95	126	Buildings 62, 63, 64, and 65 . . . . .	136
83	Features which predate Building 46 . . .	95	127	Buildings 64 and 65 and complex of small pits on Plots I and J . . . . .	137
84	Building 43 . . . . .	96	128	Contours of allotments . . . . .	139
85	Legionary ditch showing positions of the human remains . . . . .	97	129	Cultivation beds . . . . .	140
86	Human skulls and humerus showing signs of ?executions . . . . .	98	130	A profile of the allotments compared with a profile across modern asparagus beds in the Cher valley, France . . . <i>microfiche</i>	230
87	Building 34 . . . . .	99	131	?Water-tank (GF61) of Period 5 . . . . .	142
88	Building(s) 37 . . . . .	100	132	Lead coffin . . . . .	143
89	Small-scale plan showing main areas within Building(s) 37 . . . . .	101	133	Burial in bottom of Period 5/6 ditch and bases of defensive ditches . . . . .	144
90	Balkerne Lane Period 2: general plan . .	103	134	Location of Site A Trench 5 . <i>microfiche</i>	231
91	Balkerne Lane Period 2 (east and west) . . . . . <i>outside, Sheet 3b</i>	103	135	Location of Building 66 . . . . . <i>microfiche</i>	231
92	Buildings 39 and 40 . . . . .	104	136	Wooden piles at Building 66 . . . . .	146
93	Buildings 44 and 45 and part of Building 46 . . . . . <i>outside, Sheet 4a</i>	106	137	Conjectural reconstruction of wall plaster found in Building 51 . . . . .	147
94	Ovens in Building 44 . . . . .	106	138	Wall plaster from Building 51 . . . . .	148
95	Collapsed wattle-and-stake wall in Building 44 . . . . .	107	139	Wall plaster from Building 51 . . . . .	149
96	Building 46 . . . . .	109	140	Wall plaster from Building 51 . . . . .	150
97	Balkerne Lane Period 3 (east): general plan . . . . .	110	141	Wall plaster from Building 51 . . . . .	151
98	Balkerne Lane Period 3 (east) . . . . . <i>outside, Sheet 4a</i>	110	142	Painted gladiator from Building 51 . . . . .	152
99	Balkerne Lane Period 4: general plan . .	112	143	Wall plaster from Building 59 . . . . .	153
100	Balkerne Lane Period 4 (east) . . . . . <i>outside, Sheet 4b</i>	112	144	The Middleborough site in relation to the river Colne and the north-west corner of the <i>colonia</i> . . . . .	156
101	Balkerne Lane AD 60/1-150 (west) . . . . . <i>outside, Sheet 3b</i>	113	145	Buildings 67 and 68 . . . . .	157
102	Balkerne Lane Period 5: general plan . .	113	146	Relationship of Buildings 67, 69, and 70 . . . . .	158
103	Balkerne Lane Period 5 (east) . . . . . <i>outside, Sheet 4b</i>	114	147	Hearths and ovens . . . . .	159
104	Balkerne Lane AD 150-250 (west) . . . . . <i>outside, Sheet 4b</i>	114	148	Building 69, Phase 1 . . . . .	160
105	Balkerne Lane Periods 5c and 6: general plan . . . . .	114	149	Building 69, Phase 2 . . . . .	161
106	Balkerne Lane Periods 5c and 6 (east and west) . . . . . <i>outside, Sheet 5a</i>	115	150	Wall plaster from east wall of Room 4a in Building 69, Phase 2 . . . . .	162
107	Water-pipe junction collars . . . . .	115	151	Building 70 . . . . . <i>outside, Sheet 5b</i>	162
108	Period 5 water-pipes and Building 53 . .	116	152	Building 70 viewed from the west . . . . .	163
109	The diverted water-pipes . . . . .	117	153	Middleborough Period 3, Buildings 70-3 . . . . .	164
110	Buildings 47 and 48 . . . . .	118	154	Depressions in floor under 'The Mosaic of the Wrestling Cupids' . . . . .	165
111	Building 51 . . . . . <i>outside, Sheet 4a</i>	118	155	Detail of evidence for base set into 'The Mosaic of the Wrestling Cupids' . . . . .	165
112	?Aqueduct . . . . .	120	156	Painting of the mosaic in Room 4 of Building 70 . . . . .	167
113	Balkerne Gate . . . . .	121	157	Reconstruction of mosaic in Room 4 . .	167
114	Two possible reconstructions of the Balkerne Gate . . . . .	123	158	Painting of 'The Mosaic of the Wrestling Cupids' . . . . .	169
115	Building 52 — the Romano-Celtic temple	124	159	Painting of 'The Mosaic of the Wrestling Cupids' . . . . .	170
116	The Romano-Celtic temple . . . . .	125	160	Schematic representation of motifs in border of 'The Mosaic of the Wrestling Cupids' . . . . .	173
117	Dimensions of Romano-Celtic temple . .	126	161	Arrangement of motifs in the border of 'The Mosaic of the Wrestling Cupids' . .	173
118	Wheel ruts KF84 . . . . .	126	162	Dimensions of the 'The Mosaic of the Wrestling Cupids' . . . . .	174
119	Building 53: holes left by decayed piles	127	163	Buildings 71 and 72 . . . . .	175
120	Buildings 54-8 . . . . .	129	164	Room 3a/b of Building 71 . . . . .	177
121	Building 59 . . . . .	130	165	Rooms 4 and 5 of Building 71 . . . . .	178
122	Building 59 . . . . .	131	166	Rooms 4 and 5 of Building 71 viewed from the north . . . . .	179
123	Profile of foundation of Building 59 . . . . . <i>microfiche</i>	230	167	Development of Building 71 . . . . .	180
124	Building 60 . . . . .	133	168	Fragment of mosaic in Building 71, Room 3b . . . . .	180
125	Building 60 . . . . .	134			





## INTRODUCTION

This report is intended to be only a description of the structures and other substantial remains found during the major excavations in Colchester between 1971 and 1978 at Lion Walk, Balcerne Lane, and Middleborough (Fig 1). The finds selected for inclusion here are those which were part of structures (eg wall plaster and building tile) or which had impinged on the site in some way (eg as a votive pot or a *gridiron in situ*). With the exception of coins, Roman objects which were 'loose', eg brooches and querns, are dealt with in *CAR 2*; the remaining finds will be included in subsequent volumes of the series. The dates given in the report below are based on the coins and preliminary examinations of the pottery. Hence refinement and reassessment of some of the dating evidence is almost inevitable when the study and classification of the pottery is completed. Any changes will be set out in the pottery report together with a comprehensive statement of the dating evidence for all three sites. It is unfortunate that the structural reports have had to be prepared without the benefit of the definitive pottery study but the size of the task in hand and the very limited budget available for the post-excavation work in general leave a choice between publication in the present form in 1984 or publication in a more comprehensive fashion probably in the 1990s.

The Lion Walk excavation took place between 1971 and 1974 before the construction of the Lion Walk shopping precinct. The work was undertaken with the permission of the Colchester Borough Council and Frincon Holdings (now the Land and House Property Corporation Ltd). The major excavation at Balcerne Lane was carried out between 1973 and 1976 before the building of St Mary's multi-storey car park and the western section of the inner relief road. The Colchester Borough Council owns the land concerned and made the site available for excavation. The third site was at Middleborough. This was dug in 1978 by permission of the Royal London Mutual Insurance Society Ltd before work began on the construction of the company's new office block.

The extent of the destruction of the archaeological remains at Lion Walk and Balcerne Lane was substantial since the redevelopment projects in both cases necessitated the lowering of large areas of the town to below the lowest surviving archaeological levels. At Lion Walk there is now an underground basement which is about 6 m deep and covers an area about 1.5 hectares (3.7 acres). At Balcerne Lane the top of the hill has been removed to a depth of up to 6 m over an area of about 1.0 hectare (2.5 acres). Since the new building at Middleborough was to be built on piles, the archaeological work on this site was confined to the latest levels. A shortage of funds meant that the Middleborough excavations were

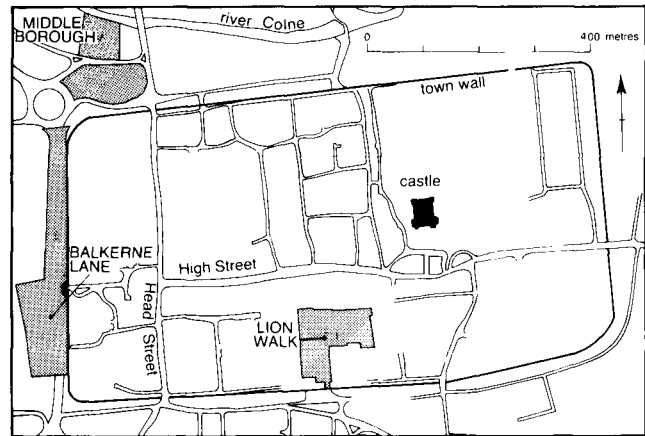


Fig 1 The positions of the Lion Walk, Balcerne Lane, and Middleborough sites.

concentrated on the eastern half of the site where the archaeological deposits proved to be the most significant. A large basement was built on the western side of the site in an area in which the archaeological remains were comparatively sparse.

The funds available for each of the three sites were very inadequate. Areas were left unexamined, drastic machine stripping had to be undertaken and the resources devoted to post-excavation work were minimal apart from what was needed for the preliminary sorting and marking of the finds. Losses on the sites were minimized by excavating the areas which appeared to be the most important and priority was given to examining the deposits which were Boudican or earlier. Before machines were used to trench or strip out Roman deposits (eg pp 66, 69, 127, & 132), the latest Roman levels were examined and the visible features planned. The only post-Roman deposits removed by machine were the accumulations of topsoil (p92) and the remains of buildings and other structures of c 18th-century or later date. Most of the site at Lion Walk and all of the Balcerne Lane and Middleborough sites were available for excavation.

At Lion Walk and Balcerne Lane the sites were excavated and recorded as a series of self-contained sub-sites. Each of the sub-sites was referred to by a letter (eg Site J at Lion Walk) and the sites themselves were given codes, ie LWC for Lion Walk, BKC for Balcerne Lane and MID for Middleborough. The recording systems were broadly the same for all three sites. For Middleborough and each sub-site at Lion Walk and Balcerne Lane, every group of finds was allocated a find number which was unique to the context concerned. Every feature was given a feature number (indicated by the prefix 'F') and from 1973 a similar system of layer numbers was introduced.

Hence as examples, LWC AL45 is Layer 45 from Site A at Lion Walk and BKC V405 is Find Number 405 from Site V at Balcerne Lane. Site plans were drawn at 1:20 and sections and profiles were recorded at 1:10.

Most of the section drawings are illustrated here mainly on microfiche. The published drawings are interpretative rather than descriptive. No soil descriptions have been included, nor has any attempt been made to indicate the types of soil present in the sections by means of a key. This is because most of the soils are very similar to one another and their descriptions are thus of limited value for the interpretation of stratigraphy. The soils tend to be sandy loam or loamy sand in the 10YR range on the Munsell Color Chart. Generally the parent material is yellowish-brown sand (around 10YR 5/6) and the colour of the soil is dependent on factors such as the presence of charcoal, organic matter, iron precipitates, and burnt soil. Inclusions like gravel or oyster shell are usually indicated in the published section drawings when they occur in large numbers. All the section drawings (including those not published) and all the soil descriptions are available for inspection in the Colchester and Essex Museum together with all the finds and site records. The conventions used in the published plans and sections are given in Figures 2 (p 2) and 3 (microfiche) respectively. The section conventions are also shown on Sheet 6.

Balcerne Lane is described in terms of Periods 1 to 6. This framework, being derived from the sequence of town defences found on the site, is also used in relation to the development of Colchester (pp3-20). The Roman remains at the Middleborough site are attributed to one of three periods, each of which is consistent across the Middleborough site but peculiar to it. Lion Walk could not be phased in terms of

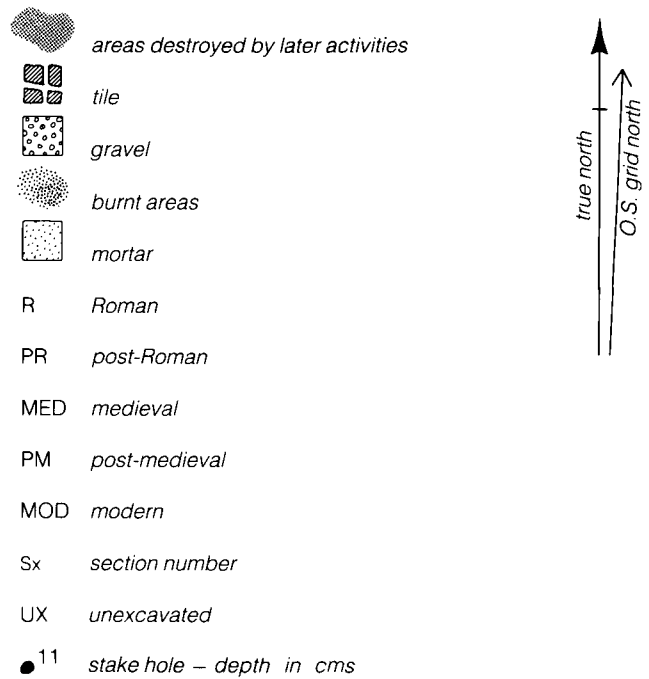


Fig 2 Plan conventions.

internally consistent periods so that each sub-site has its own system. On all the Lion Walk sub-sites except the slightly anomalous Site L, Periods 1 and 2 relate to the fortress and pre-Boudican colony respectively (as at Balcerne Lane). Period 3 on most Lion Walk sub-sites broadly belongs to AD 60/1-100 (Fig 35, p48) and Period 4 (plus Period 5 on Sites B, J, H, & P) to c 100/50-400+ (Fig 40, p53). Otherwise major structures, including all those of post-Roman origin, are referred to in terms of their probable dates. The period systems for the three sites can be summarised as shown below.

**Lion Walk 1971-4 (LWC)**

**Sites A & R**

- Period 1 c 44 - c 49/55
- 2 c 49/55 - 60/1
- 3 60/1 - c 275
- 4a, b, & c c 275 - c 400+

**Site B**

- Period 1 c 44 - c 49/55
- 2 c 49/55 - 60/1
- 3 60/1 - c 80/90
- 4 c 80/90 - c 100
- 5 c 100 - c 350

**Sites C & Q**

- Period 1 c 44 - c 49/55
- 2 c 49/55 - 60/1
- 3a 60/1 - c 80?
- 3b c 80? - c 100 (150)
- 4 c 150 - 400+

**Site L**

- Period 1 c 44 - c 49/55
- 2 c 49/55 - c 85
- 3a c 85 - c 90
- 3b c 90 - c 100 (150?)
- 4a c 150 - 330/5+
- 4b 330/5+ - 400+
- 4(1) c 150 - c 200
- 4(2) c 200 - c 250
- 4(3) c 250 - 400+

**Sites K & T**

- Period 1 c 44 - c 49/55
- 2 c 49/55 - 60/1
- 3 60/1 - c 100
- 4a & b c 150 - c 400+

**Sites J, H, & P**

- Period 1 c 44 - c 49/55
- 2 c 49/55 - 60/1
- 3 c 60/75 - c 100/150
- 4a c 150 - ?200
- 4b ?200 - c 275/300
- 5 c 300 - c 400+

**Balcerne Lane 1973-6 (BKC)**

The following are the areas at Balcerne Lane: A, B, C, D, E, G, H, J, K, M, N, P, R, S, T, U, & V. These share the following phases:

- Period 1a c 43 - c 49
- 1b c 49 - c 50/?55
- 2 c 50/?55 - 60/1
- 3a & b 60/1 - c 75/80
- 4a c 75/80 - c 80/5
- 4b c 80/5
- 4c c 80/5 - c 100
- 4d c 100 - c 125
- 5a c 100/25 - c 150
- 5b(1)&(2) c 150 - c 250
- 5c c 250 - c 300
- 6 c 300 - 400+

**Middleborough 1978 (MID)**

- Period 1 late 1st to early 2nd century
- 2 early to mid 2nd century
- 3 mid 2nd century to c 300

### The fortress (Colchester Period 1)

The major archaeological breakthrough in Colchester during the 1970s was twofold. The legionary fortress was discovered and the fact realised that the colony which followed it was not a new purpose-built town but was instead the redundant fortress reused. In 1965, Miss B R K Dunnett (now Mrs Niblett) excavated a Claudian building (Dunnett 1967) which she later felt may have been part of a military base in the North Hill area of the town (Dunnett 1971, 2). At Lion Walk in 1972, some pre-Boudican buildings and defences were discovered which were laid out in a fashion characteristic of fortresses. Although the defences had been demolished some considerable time before the fire of AD 60/1, parts of several of the buildings had been burnt implying that they existed at the time of the revolt. The evidence for the street layout of the colony as a whole was carefully re-examined and a new plan was produced. From this a tentative plan of the fortress emerged based on the assumption that many of the civilian streets were of military origin and by taking advantage of the fact that there seemed to be a difference in alignment between the military base and the eastern part of the colony (Crummy 1977). The first plan of the fortress was later supported by the results of the Balkerne Lane excavations and in 1981-2 it was confirmed beyond doubt at the Culver Street site. Figure 4 summarizes all the information available in 1982 about the layout of the fortress. In the following description, various references are made to the Culver Street excavation. This site will be described fully in a later volume of the *Colchester Archaeological Reports*. (See also *Britannia*, 13 (1982), 371.)

The fortress was about 49 acres (20 hectares) in area and had a substantial annexe on its east side. It was aligned to within a half a degree of true north and faced eastwards. The fortress seems to have been of a neat, regular plan apart from the north-west corner where the steepness of the slope seems to have led to some distortion. The fortress at Colchester has much in common in its layout and general dimensions with the better known example at Caerleon (Fig 5) and proves that the standardization visible in the plans of the later fortresses was in existence by the Claudian period.

Characteristic of most of the military buildings found so far is that many of their walls were built on low mortared plinths (*opus caementicium*). These were cast between wooden shuttering and made of a mixture of mortar and pebbles with some septaria (p 20). Military buildings with this type of wall have been excavated at Lion Walk, North Hill (Fig 4, Site 6; Dunnett 1967), St Mary's Rectory (Fig 4, Site 7; Dunnett 1971, 62-6), and the Gilbert School (Fig 4,

Site 8; Crummy 1977, 82) and in 1982 part of another was recorded on a building site at St Mary's Cottage which, because of its position, enables six barrack blocks to be restored conjecturally in the south-west corner of the fortress (Fig 4, Site 13). Immediately east of the *via principalis*, buildings without this type of wall have been found on two different sites. At Culver Street, two large buildings had walls made of large timber uprights which had been dropped into construction trenches up to 1.1 m deep. These buildings probably belonged to the group of eight commonly found lining one side of the *via principalis* in a typical fortress. Of the group, six would have been tribunes' houses. At the Telephone Exchange, the earliest remains were comparatively slight (Fig 4, Site 10; Dunnett 1971, 7-11) and may have part been of store-blocks lining the main street.

The floors of the buildings were of daub or sand. Wooden examples seem to have been very rare although the remains of an early wooden floor were found at Culver Street. It is unlikely that any walls were plastered and painted in the military period. Where wall plaster occurs in pre-Boudican contexts, the cases concerned could have derived from civilian improvements to reused military buildings. Of significance in this respect is the absence of wall plaster in the remains of the ?tribunes' houses.

The defences of the fortress have been identified at two places, ie at Lion Walk (p 31) and Balkerne Lane (p 93). In 1964 Miss Dunnett located the southern side of an east-west ditch at Nunn's Road (Fig 4, Site 2) and in 1967 at 44 North Hill she excavated another stretch of ditch, thought probably to be the same feature (Fig 4, Site 1). No direct dating evidence was recovered on either occasion but on the strength of a deposit sealing the backfill of the ditch at 44 North Hill, a late Flavian or Trajanic date was tentatively suggested (Dunnett 1971, 43-4). Whatever its date, this ditch marked the northern limit of settlement at some stage before the building of the town wall. The area between the ditch and the town wall to the south is neatly bisected by the western end of the *decumanus maximus*. Thus the ditch must have belonged to the fortress or else it must have coincided with the site of the military defences and have been part of the 'Period 3' ditch discovered at Balkerne Lane (p 115 & Crummy 1977, 101).

The plan of the layout of the interior of the fortress is still largely dependent on the hypothesis that most of the streets of the western half of the colony were of military origin since only a few streets have yet been examined (Crummy 1977, 82-3). Early streets have been found at the Cups Hotel (Fig 4, Site 5; *ibid*), Head Street (Fig 4, Site 9; Hull 1958, 69), the Telephone Exchange (Fig 4, Site 10; Dunnett 1971, 7-10), Church

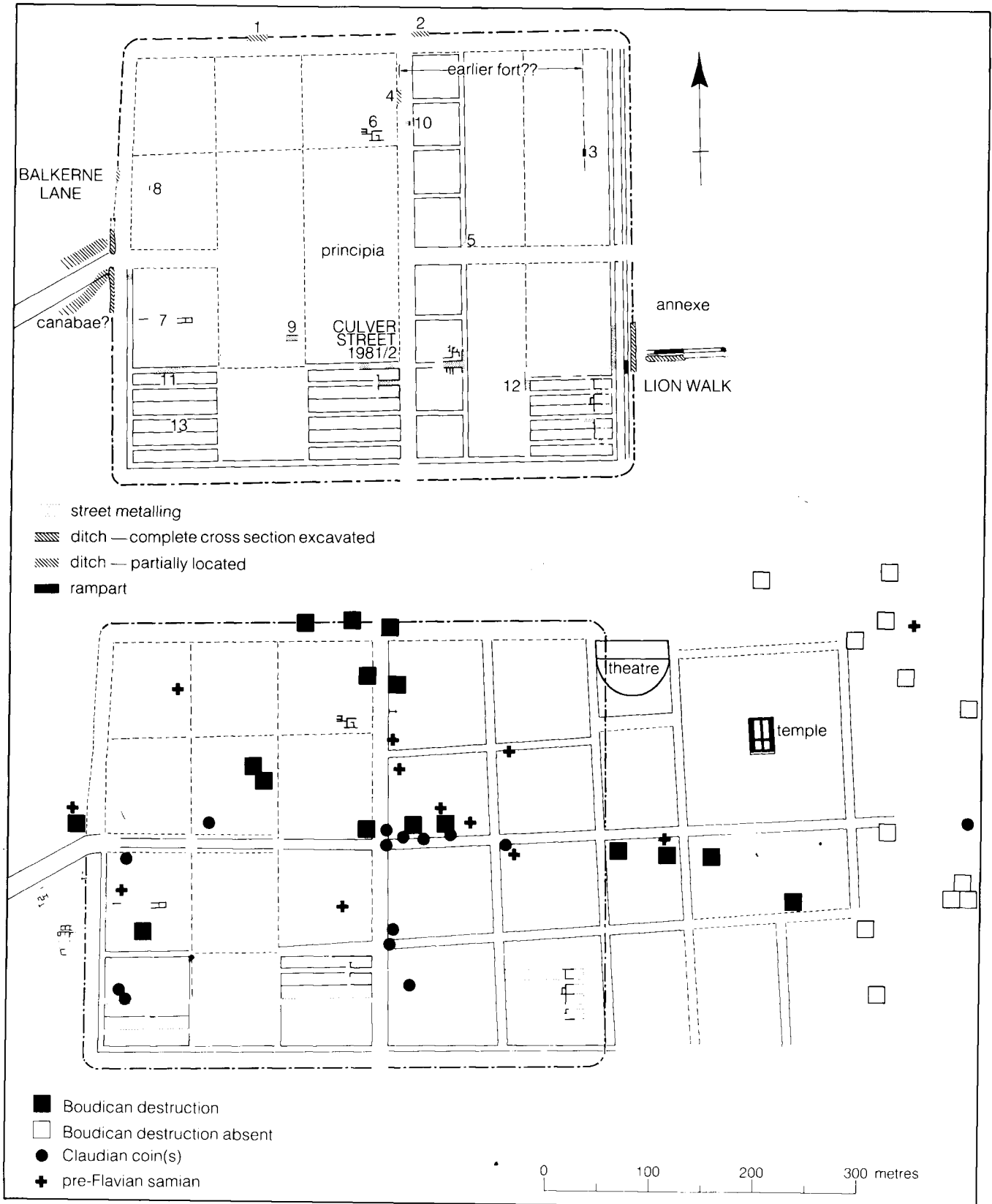


Fig 4 Above: plan of the fortress (Colchester Period 1); below: Colchester Period 2 (c AD 49-60/1). [Pages 3-9]

Lane (Fig 4, Site 11; Crummy 1977, 83), and at Lion Walk, Site U (Fig 4, Site 12). Nothing is known about the gates other than their probable locations. Of note is the dramatic evidence from Balcerne Lane of corpses of executed people possibly having been displayed in and around the west gate (pp94-8).

In 1963, the Archaeological Research Group, Colchester under the direction of Mr J Blyth found in *Insula* 10 a deep north-south ditch filled mostly with clean sand and sealed by a layer of Boudican destruction debris (Fig 4, Site 4). In 1964 Miss Dunnnett discovered under the street between *Insulae* 12 and 20 a 'turf' rampart the direction of which could not be established (Fig 4, Site 3; Dunnnett 1971, 38-42). For the sake of simplicity, the 1963 ditch and the 1964 rampart are here associated and regarded as having been part of a fort which, because of the continuity between the fortress and the town, presumably preceded the main military base. However the true situation may have been more complicated.

The extent and the purpose of the annexe are obscure. It was clearly a later addition to the fortress (pp 31-2). The defences have only been located on two sites, ie Lion Walk and Long Wyre Street (Goodburn 1979, 308). No buildings have yet been found inside the annexe and the only evidence of activity associated with it is iron-making at the rear of its rampart (p31).

At Balcerne Lane, some buildings existed outside the west gate of the fortress where the predominant activity was probably iron-making (p93). It is not clear how early this settlement was, and there is even the possibility that it belonged exclusively to the first few years in the life of the colony (pp 8 & 93). Evidence of early metal-working is common. It has also been found inside the annexe (already mentioned) and under the civilian street at Lion Walk (pp35-6).

No evidence has yet been found of a piped water-supply in the military period. The leat found at the Sheepen site in the 1930s (Hawkes & Hull 1947, 34 & pl 107) is the only example known of works associated with water at this early stage apart from timber wells near the river (p26).

Although not described here, the excavations at Culver Street are very important for the following reasons. Confirmation has been obtained at Culver Street of the accuracy of the original, tentative plan setting out the likely layout and orientation of the fortress. The positions of the *via principalis* and the tribunes' houses have been proven and for the first time two clear structural phases, both of a major character, were found in a pre-Boudican context (Fig 4). The military buildings found on previous excavations were always reused or demolished without replacement (apart from the rather odd structure at the Telephone Exchange site; Dunnnett 1971, 7-11) and thus the possibility could never be entirely discounted that they were in reality of civilian origin and therefore the supposed fortress did not exist at all. However at Culver Street, the tribunes' houses were demolished sometime before 60/1 and a new street with buildings to either side was laid on top. The new buildings were subsequently destroyed during the native revolt.

## The planning of the fortress

Careful measurements of a large-scale plan of the Colchester fortress reveal the way in which its plan was conceived (Fig 6). By taking the Roman foot (*pes monetalis*) to equal 0.295 m, the ground area of the fortress can be divided into six north-to-south strips 300 and 200 feet across. The area east of the *via principalis* can be divided into two squares 650 Roman feet across. From one of the 200 foot wide strips were cut the tribunes' houses and the *via principalis*. At Culver Street, the barracks and the two tribunes' houses were 300 feet across, measured from the inside of the *via sagularis*. Thus the strategy of the planner can be summarised as follows (Fig 6):

First he marked out on his plan at an appropriate size, strips 300 and 200 foot wide. Then he set out the *via praetoria* and the *via decumana* so that these were 60 feet across. (The exact widths are not certain.) At the same time he allocated a 50 foot wide strip for the *via principalis* and marked off the northern and southern limits of the street system so that these were 650 feet to the north and south of the frontages of the *via praetoria* and the *via decumana*. Thus the street plan of the fortress covered a theoretical area of 1360 x 1600 feet.

The next stage involved delineating the minor streets. These are assumed to have been 20 feet across but with the exception of the *via sagularis* they could have been as much as 30 foot wide. The *via sagularis* has been excavated in two places (pp 37 & 94) and its width established at around 20 feet.

Finally the building plots were marked out. Those for the tribunes' houses seem to have been mainly 140 x 150 feet. There may have been store-blocks along the eastern frontage of the *via principalis* in which case the tribunes' houses would not have been the full 150 feet across, east to west. Probably the area south of the *via decumana* would have been occupied by ten barracks taking up 600 feet. If so, this would have left 30 feet for store-blocks at the north end — more if the *via decumana* was narrower than shown in Figure 6.

(Close inspection of plans of other fortresses indicates that the scheme described above for Colchester may prove to have been broadly typical of the planning of fortresses dating from the mid 1st century. Especially common appears to have been the 300 foot dimension. The tentative evidence for this conclusion was set out in a paper read at a conference in London in 1983 on Romano-British topography. It is expected that the proceedings will be published by the Council for British Archaeology.)

## Pre-Boudican colony (Colchester Period 2)

A problem with converting fortresses into towns was that the layout of the military streets did not form a grid. Apart from the *via sagularis*, the only streets to cross fortresses from one side to the other all shared the same direction as the *via principalis*. At Colchester, the streets in the *retentura* were probably all kept for civilian use (certainly the north-south ones) and a new street-grid was laid out to the east. The streets of the

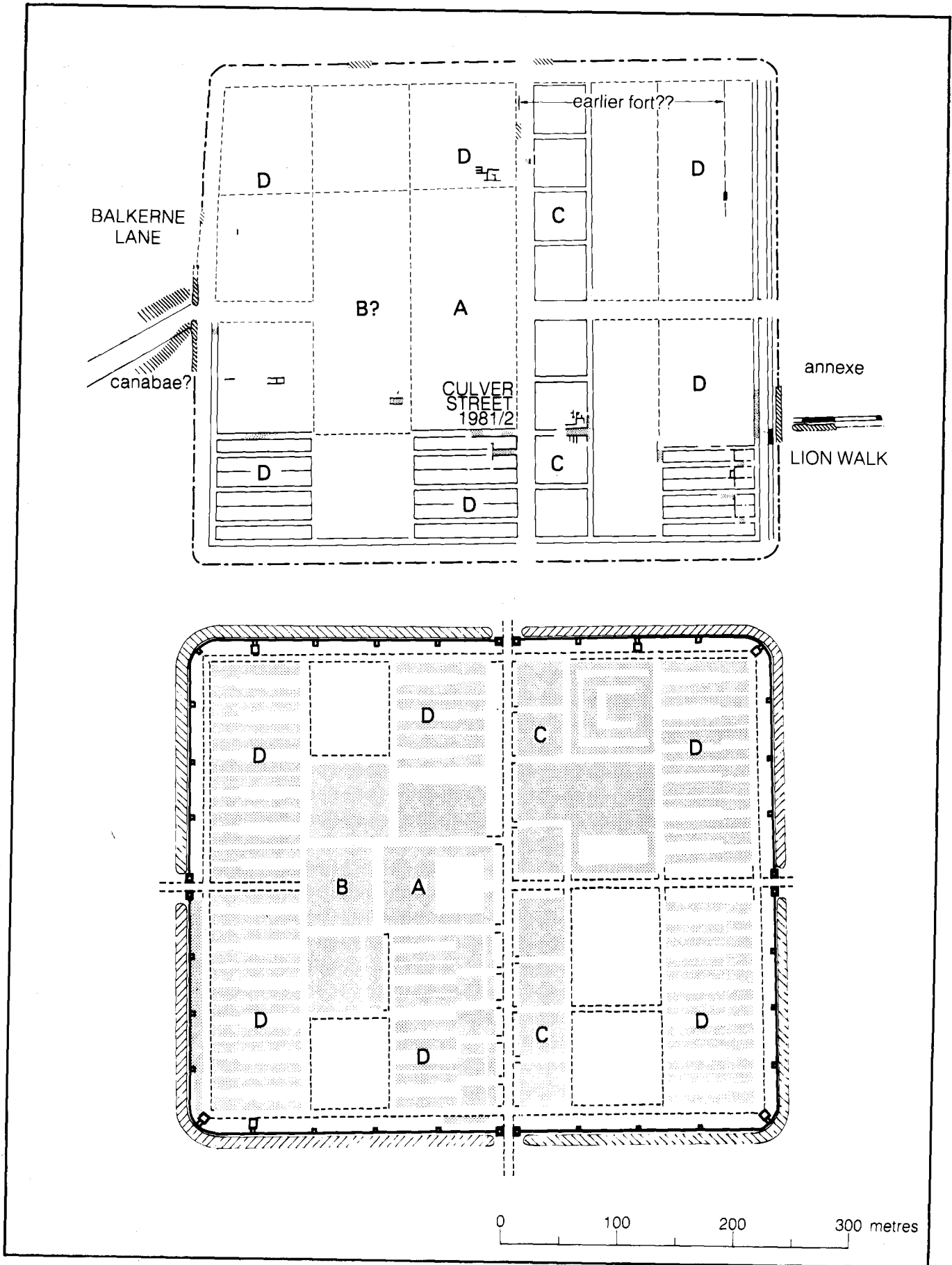


Fig 5 Comparison of the plans of the fortresses at Colchester and Caerleon. A...principia, B...praetorium, C...tribunes' houses (six out of the eight buildings), D...barracks. [Page 3]





latter covered the area of the annexe and extended westwards into the fortress at the expense of the eastern defences and existing buildings where these were in the way (metal-working structures at Lion Walk and a ?tribune's house at Culver Street). In the new colony the site of the military annexe seems mainly to have been given over to public buildings, namely the Temple of Claudius, a theatre, and probably at least two other buildings, one in *Insula* 29 and the other in *Insula* 30. To have made room for these within the site of the fortress would have required much demolition, so that this concentration of large, new buildings probably indicates that a large proportion of the military structures was retained for the colony and that there were few if any substantial military buildings worth keeping in the annexe. In most places where early buildings have been found, these have been reused at least in part. The exceptions are Buildings 1, 2, and 7 at Lion Walk, the possible tribunes' houses at Culver Street, and the possible store-block at the site of the Telephone Exchange (see above).

The *praetorium* and thus presumably the *principia* may have been demolished and their sites bisected by a new street laid between the ends of the *via decumana* and the *via praetoria* to form an unbroken *decumanus maximus* for the town. The evidence for this is tenuous and rests on the observation by Miss B R K Dunnett of some street metalling on the probable site of the *praetorium* (Dunnett 1971, fig 3).

The new streets and the public buildings on the east side were laid out on a slightly different alignment to the fortress, the difference between the two being about two to four degrees. The replacement for the *via sagularis* on the east side was sited to lie obliquely across the levelled defences so that at the north end it coincided with the *via sagularis* and at the south end it overlay the backfilled ditch. On the other three sides of its circuit, the *via sagularis* seems to have been retained. At Balkerne Lane (Buildings 44-6), Lion Walk (Building 9), and North Hill (Dunnett 1971, fig 1), buildings have been found which were destroyed in 60/1 but which, to judge from their locations, must have been built over the backfilled legionary ditch and must have fronted on to the former *via sagularis*.

All this explains the otherwise puzzling passage in Tacitus: '*nec arduum videbatur excindere coloniam nullis munimentis saeptam; quod ducibus nostris parum provisum erat, dum amoenitati prius quam usui consulitur*' (*Annals* xiv.32). Why was it that defences could not be provided because of the need for amenities? What could amenities have to do with defences? The answer is now clear. The amenities referred to were the civic buildings set out on the east side of the town; because so much of the fortress was being retained, the defences had to be demolished and space found on the east. No doubt failure to replace these defences was bitterly regretted later.

The site of the theatre was first postulated by M R Hull (1960, 302) and was confirmed in 1981. The building partly uncovered in 1981 may not have been of pre-Boudican origin and thus is not necessarily the theatre referred to by Tacitus. However if the building is post-Boudican, then it probably shared the same site as the

earlier theatre (Crummy 1982b). Of significance is the alignment of the theatre. This was the same as that of the fortress, not the new colonial street system. The northern edge of the theatre seems to have fronted on to the line of the *via sagularis* extended eastwards and its western side reached the north-south *via sagularis* where this coincided with the north-south street of the early colony. This odd situation is explicable if the theatre already existed when the north-south street of the colony was laid out.

The extent of the annexe is not known. Its defences have been detected only on its south side where the bank and ditch have been traced over a distance of 61 m between the sites at Lion Walk and Long Wyre Street. The alignment of the theatre hints that the north defences of the annexe formed a continuous east-west line with those of the fortress. Moreover, the area covered by the new buildings and streets of the early colony probably coincided with the site of the fortress and annexe on the basis of the assumption that all the land confiscated for the military base was transferred to the colony. At Balkerne Lane the military bank and ditch shared the same position as the defences of the later town thus indicating that, at least on the west side, there was continuity between the boundaries of the fortress and its civilian successor.

There are several reasons to suggest that there was a hiatus between the evacuation of the garrison and the setting out of the new streets of the colony. At Balkerne Lane, the legionary defences do not appear to have been levelled as soon as the garrison was withdrawn but instead suffered a period of neglect indicative of the army's absence. The legionary ditch became a dumping place for debris from metal-working and, not only were pits dug along the outer edge of the ditch, but also a building (Building(s) 37) associated with the metal-working was erected on top of the southern side of the main street close to where it passed through the west gate of the fortress. All this points to a period when the ditch was still open but not under military control. At the other side of town, the alignment of the theatre seems to indicate that the laying out of the new colonial street grid did not follow hard on the levelling of the defences on the east side of the fortress, but that instead there had been a lapse of time sufficient for work to have started on its construction on a substantial scale. This is because the theatre, despite having been built over the backfilled legionary defences, was aligned on the fortress rather than the eastern street grid.

The circumstances and duration of this apparent hiatus are hard to judge so for the purposes of this report the end of Period 1 is broadly regarded as dating to 50/55. Probably the interval was to be measured in years rather than months and may have even have been of five years or more duration if the colonial street system was not laid out until after the death of Claudius. Dr Fishwick has argued that the building of the Temple of Claudius would not have been started during Claudius's lifetime (Fishwick 1972). Since the *temenos* of the temple was the principal element of the new colonial street system and clearly conceived as such from the beginning, then the system itself would

not have been laid out until after 54 if the theory about the temple is correct. Certainly the new street system was well established by the time of the Boudican revolt and had been in existence for some time. This is made clear at Building 8 at Lion Walk. This was a house which had stood on the southern frontage of one of the streets of the new grid and had undergone an extensive series of structural alterations before the fire (pp40-1). Of course on the basis of this sequence it is impossible to tell exactly when Building 8 and hence the street system were constructed but a date of 55 would be compatible with the archaeological evidence. Although the *insula* in which the temple stood was planned as part of the new grid, it is possible that the temple itself was a later addition and that originally the *insula* contained a monumental altar like that at Lyons (Fishwick 1972). If this was the case then the street grid could date to as early as 49 and the alignment of the theatre must have been an anomaly dictated by circumstances inherited from the fortress and as yet not understood. Perhaps the street to the north bounding the theatre and temple *insula* corresponded to the northern limit of the annexe and therefore the theatre was aligned on a boundary of military origin which survived because the land occupied by the fortress was transferred without addition or subtraction to the colony.

The neglect of the defences on the west side of the colony may have been contemporary with the building of the theatre if the complete circuit of the defences was not levelled as one operation. However it would seem odd if the bank and ditch on the east side had been levelled whilst its western counterpart was left alone to become what would have been a substantial eyesore. Thus probably the hiatus was of two phases. The first was an interval of several months, perhaps years, which was terminated by the levelling of the complete defensive system. During this time at Balkerne Lane, Building(s) 37 was built and rubbish was disposed of in the butt ends of the ditch. The second phase saw the construction of the theatre and ended probably *c* 55 with the laying out of the new colonial street system and a start on the building of the Temple of Claudius.

To summarize the various permutations, there seem to be four possible interpretations. Common to all of these are three assumptions: i) work on the building of the Temple of Claudius began *c* 55, ii) there was an interval between the evacuation of the fortress by the army in 49 and the levelling of the defences on the west side, and iii) this levelling, whenever it took place, was quickly followed by the construction of Buildings 44-6. Of the four interpretations, the first seems the most plausible. These are as follows.

*Interpretation 1.* The defences were neglected on all four sides for at least five years. The entire defensive circuit was levelled in 54 or shortly afterwards and over the backfilled defences were laid out a new street grid, a theatre, Building 9 at Lion Walk, Buildings 44-6 at Balkerne Lane, and other houses on North Hill.

*Interpretation 2.* This is the same as Interpretation 1, the differences being that the levelling of the defences and the subsequent building works occurred in 49 or

shortly afterwards and that the temple was preceded by an altar.

*Interpretation 3.* The defences were neglected on the west side but were filled in *c* 49 on the east side and perhaps elsewhere. This was quickly followed by the construction of the theatre. In 54 or later, the street grid was laid out and the temple was built.

*Interpretation 4.* This is the same as Interpretation 3 except that the grid was laid out before 54 and the temple was preceded by an altar.

## Reuse of fortresses in Britain

Colchester is one of five Roman towns in Britain now known to overlie the sites of military fortresses, the others being Gloucester, Lincoln, Wroxeter, and Exeter. Excavations in these places over the last decade or so, especially at Gloucester, have shown that the relationships between the fortresses concerned and the later towns extended to much more than simply common sites. There are now proven examples of the reuse in civilian contexts of military streets, gates, defences and building plots and, in addition to that at Colchester, there is limited evidence for the survival of buildings. The impression gained from this work — certainly at Colchester — is that *most* of the streets, buildings and other structures in these fortresses were probably kept for civilian use although there also could be substantial topographical changes. In this respect Exeter resembled Colchester in that the military street system was altered and the civic forum and basilica were not built on the site of the *principia*. Colchester stands apart from this group because its military defences were not retained. As explained above, this enabled a large group of public buildings to be laid out on the east side of the new colony. The other towns, being post-Boudican foundations, kept their military defences with the effect that scope for expansion and major building projects was reduced. For an illustrated comparison of the development of these five towns, readers are referred to an article in *Britannia*, 13 (Crummy 1982a).

The most difficult aspect of this subject concerns the degree to which military buildings were retained. Generally this is taken to have been minimal except at Colchester where, because of the Boudican destruction levels which are usually clear and obvious, most of the early civilian buildings found so far within the area of the fortress were plainly of military origin. When faced with two periods of early buildings, it is very compelling in a town on the site of a fortress to equate the first with the military base and the second with the town. However the foundation dates of most of these settlements are not accurately known and, in the absence of a well-dated horizon like the Boudican fire in Colchester, the demolition of buildings is difficult to date very closely.

The reuse of fortresses in civilian contexts makes it very likely that some bases below legionary size were also adapted for civilian occupation. Fishbourne seems a good example of this (Crummy 1977, 90-1) and underlines the fact that there is still much to learn

about the relationship between the conquest of Britain and its urbanization.

## Reuse of fortresses on the continent

It would be strange if the policy of reusing fortresses was a phenomenon which occurred solely in Britain and thus parallels can be expected abroad. However, compared with Britain, the evidence for the reuse of fortresses on the continent is limited. The following notes are offered as a preliminary, rather tentative survey of a subject which, over the years ahead, should become increasingly significant. In general we should look for reused fortresses at towns which were founded during the period from Augustus to Trajan or just possibly to Hadrian (Mann 1962). The earlier limit is fixed by the introduction of the permanent fortress and the later limit by the maximum expansion of the empire and the dates of the last colonies to be founded by *deductio*. The region which seems to offer the greatest potential in this respect is in the area of Pannonia and Moesia where advances of the frontier, culminating with the conquest of Dacia, left many fortresses redundant in pacified land. The six most promising examples seem to be Cologne, Oescus, Poetovio, Sarmizegetusa, Ammaedara, and Theveste, the best known and most studied being Cologne.

At Cologne in Germania, where continuity with a military base has been claimed, the early situation is complicated by the presence not only of a legionary fortress but of the '*Oppidum Ubiorum*' founded in 38 BC as the administrative centre of the Ubii. A legionary fortress was established somewhere in the area between the second and fourth decades of the 1st century AD and in 50, at least a decade after the evacuation of the fortress, the settlement was promoted to the rank of colony. Excavations have shown that the earliest occupation on the site of the colony predates AD 50 but it is not clear whether this relates to the fortress, the '*Oppidum Ubiorum*' or even both. Some streets and buildings have been shown to have been in existence before 50 and so too has the position of the defences at least on the north side where the town wall was preceded by pre-colonial earthen defences similar in design to those of Augustan fortresses elsewhere (Filtzinger 1963). Much of the street grid appears to have been planned rather than have derived from a fortress since, certainly for the north-south streets, a consistent distance of 400 Roman feet is detectable in the layout. Thus the early sequence is uncertain.

At Oescus in Moesia, something is known of the town plan (Ivanov 1977 & 1980). This became a *colonia* under Trajan and was the site of a fortress until AD 107 (Frova 1949, 27). The remains of the fortress have not been detected and knowledge of the street system of the later town is insufficient to provide some clues. By analogy with Novae further down the Danube (*see below*), it is possible that the fortress was to the west and is to be equated with 'Oescus 1', 'Oescus 2' being originally a civil settlement outside. Poetovio (Mócsy 1974, 118-9) lay in Pannonia and

was a Trajanic colony generally thought to have been built close to the site of an earlier fortress. Unfortunately, there seems to be little useful detail available about the street plan of the town or the base presumed to have preceded it.

In Dacia, there is Sarmizegetusa which was established between AD 108 and 110 on the site of a fortress built in 102 (Cătănciu 1981, 13-4, *n* 106). Professor S S Frere has informed me by letter that the west rampart of the fortress has recently been found to the east of the stream which passed through the walled area of the town and that there is now also limited evidence that the military and civilian defences coincided on the east and probably the south sides. Of the possible examples of reused fortresses on the continent, Sarmizegetusa seems the most promising.

In Africa are Ammaedara and Theveste, colonies founded during the Flavian and Trajanic periods respectively. Unfortunately very little is known about these towns in their early phases (Fentress 1979, 126). (Also it has been argued that Thamugadi was built on the site of a fortress but this is disputed by EW B Fentress (*ibid*, 126-8). The town was about 27 acres (11 hectares) and thus was much too small to have been a fortress. Moreover its plan is hard to rationalize in terms of a military layout.)

In addition to these seven places, there are ten or so other towns which are thought *possibly* to have been built on the sites of legionary bases. Briefly these are as follows. Savaria was a Claudian colony in Pannonia (Mócsy 1974, 75-6) which has the distinctive appearance of a planned town rather than a reused military base. Also in Pannonia, there were Siscia and Sirmium both of which were Vespasianic foundations (*ibid*, 112-3). The plan available of Sirmium (*ibid*, 163, fig 29) is not very detailed and the site of the fortress is not known. Scupi was a veteran colony founded in Moesia by Vespasian (*ibid*, 115). It is a very tentative fortress site about which little is known. Likewise the colony of Ratiaria and the *municipia* of Nicopolis and Naissus. In Spain, the Augustan colony at Zaragoza (Webster 1969, 56, *n* 3) may overlie the site of a fortress. Although something is known about this colony's street grid, it is still too obscure to tell whether it is likely to have been of planned or reused origin (Martinez 1976, plan facing p 252).

Finally there are the two towns of Emona and Aosta. Aosta was a colony which was founded on the site of the camp of Terentius Varro. This he constructed during his campaign to complete the conquest of the Salassi which he achieved in 25 BC. A stretch of ditch, found under the wall of the colony, is thought possibly to have been part of the original camp (Wells 1972, 38). It seems unlikely that the latter contained buildings worth keeping for the new colony in view of the nature and period of the military occupation. Emona is possibly a Tiberian foundation generally held to be on the site of a fortress although this belief has recently been questioned.

It has been suggested that both Emona and Aosta shared the same alignments as their presumed

military predecessors. But both colonies look very much like planned towns and have a clear-cut rectangular outline with sharp corners unlike camps of this period. If there had been continuity in these cases, perhaps it was only of site, surrounding legionary lands and the principal through-streets.

Emona has been the subject of an interesting study in which an attempt was made to show that building plans and building materials were modular in design and based on standard Roman measure (Detoni & Kurent 1963). Bricks, columns, water-pipes, various kinds of tile, house plans and the town walls were all examined and related to the common system of measurement. Of special note was the demonstration in the house plans of the occurrence of the *passus* as the basic module. In other words the designs of the houses were conceived as multiples of five Roman feet. Perhaps the only aspect not covered was an examination of the planning of the layout of the *insulae* and town walls to detect the town planner's strategy. Using the measurements provided in the published study, it is possible to detect in the layout of the streets repetitive dimensions expressible in multiples of 25 Roman feet (*pedes monetales*). Thus Emona and presumably Aosta too, which we have seen was similar in several ways, were probably planned towns rather than reused military bases.

Finally, mention must be made of Novae in Moesia where in recent years considerable advances have been made which are of indirect relevance to the subject in hand (Sarnowski 1977). Novae is a good example of a redundant fortress which was absorbed by an adjacent settlement. It differs from the other places cited above because the evacuation of its fortress occurred much later than Trajan. In the 1st century, Novae was a frontier fortress with a civil settlement which developed on its east side. In the 3rd century, there was a substantial topographical reorganisation and in the 4th century the fortress site and the civil settlement, which some time earlier had attained the rank of *municipium*, formed a single urban unit. By the end of the 4th century, occupation was concentrated on the site of the fortress and the walls of the former civil settlement to the east were demolished.

Taken as a whole, the continental evidence for the conversion of fortresses into towns is so far meagre and inconclusive except possibly at Sarmizegetusa. Even allowing for the fact that probably the information presented here is neither up to date nor comprehensive, it is clear that Britain is fortunate to have not just one but five towns in which the process of reusing fortresses is being studied.

### **The development of the colony from AD 60/1 to c 125 (Colchester Periods 3 & 4)**

After the fire of 60/1 and at the start of Period 3, the colony was provided with its first defences (Fig 7). The ditch of this system was sectioned at Balcerne Lane (Sx 75, Sheet 6b) where it was found to have been a

substantial affair. In addition to the stratigraphic evidence contained in the section, proof was obtained from the relationship between the ditch and some buildings (Buildings 44-6) destroyed in 60/1 that these defences were without doubt post-Boudican (p102).

*Insula* 14 (Fig 9) has a curious narrow shape which is probably to be explained in terms of the space between the precinct of the Temple of Claudius and the line of Miss Dunnnett's North Hill ditch (p 3) projected eastwards. The alignment of *Insula* 14 is the same as that of the eastern part of the colony which was established c 50/55. The northern street of *Insula* 14 thus implies that sometime after c 50/55 but before the construction of the town wall a ditch existed in approximately the same position and alignment as the street. Since there is no evidence as yet of defences in the pre-Boudican colony, the shape of *Insula* 14 would appear to indicate the approximate site of the Period 3 defences on the north side of the town.

In about 80, the defensive ditch on the west side of the colony was filled in and Period 3 came to a close (Fig 7). The date of this event is well attested by a substantial quantity of pottery in the backfill of the ditch where this was excavated at Balcerne Lane, especially at Site K (Sx 75, Sheet 6b). An east-west ditch was discovered in 1973 in Crouch Street. This seemed to be a western extension of the southern defences of the town. Although the ditch appears to have been relatively shallow (1.5 m deep), it is likely to represent a replacement for the Period 3 ditch at Balcerne Lane and an enlargement of the defended area of the town. The area enclosed by this ditch can be estimated from the distribution of known burials and buildings west of the town wall (Fig 8). Assuming that the buildings were inside the ditched area and the burials were not, an area 300 x 500 m can be postulated. On this basis, the west limit of the enlarged enclosure seems clear but the north side is conjectural and is taken to correspond to the northern line of the Period 4 defences projected westwards.

The limit of the built-up area of the colony in Period 3 probably coincided on the south and east sides with the extent of the Period 2 settlement. Sometime between the levelling of the Period 3 defences and the building of the town wall at the start of Period 5, the northern boundary of the colony was moved northwards by about 100 m, the equivalent of a row of *insulae*. When did this expansion occur? Miss Dunnnett's distribution map of Flavian-Trajanic pottery and coins (Dunnnett 1971, fig 2, p 2), brought up to date here in Figure 7, suggests that by c 100 the town had expanded beyond the northern limit of *Insula* 14 and that this expansion probably took place before the construction of the town wall in the first part of the 2nd century. This conclusion has been reinforced by discoveries at the Middleborough site where a street was found which had been laid out at a sharp angle to the North Gate showing that the street could not have been constructed before defences had been established in this position. The earliest known activity alongside the street was indicated by a pottery

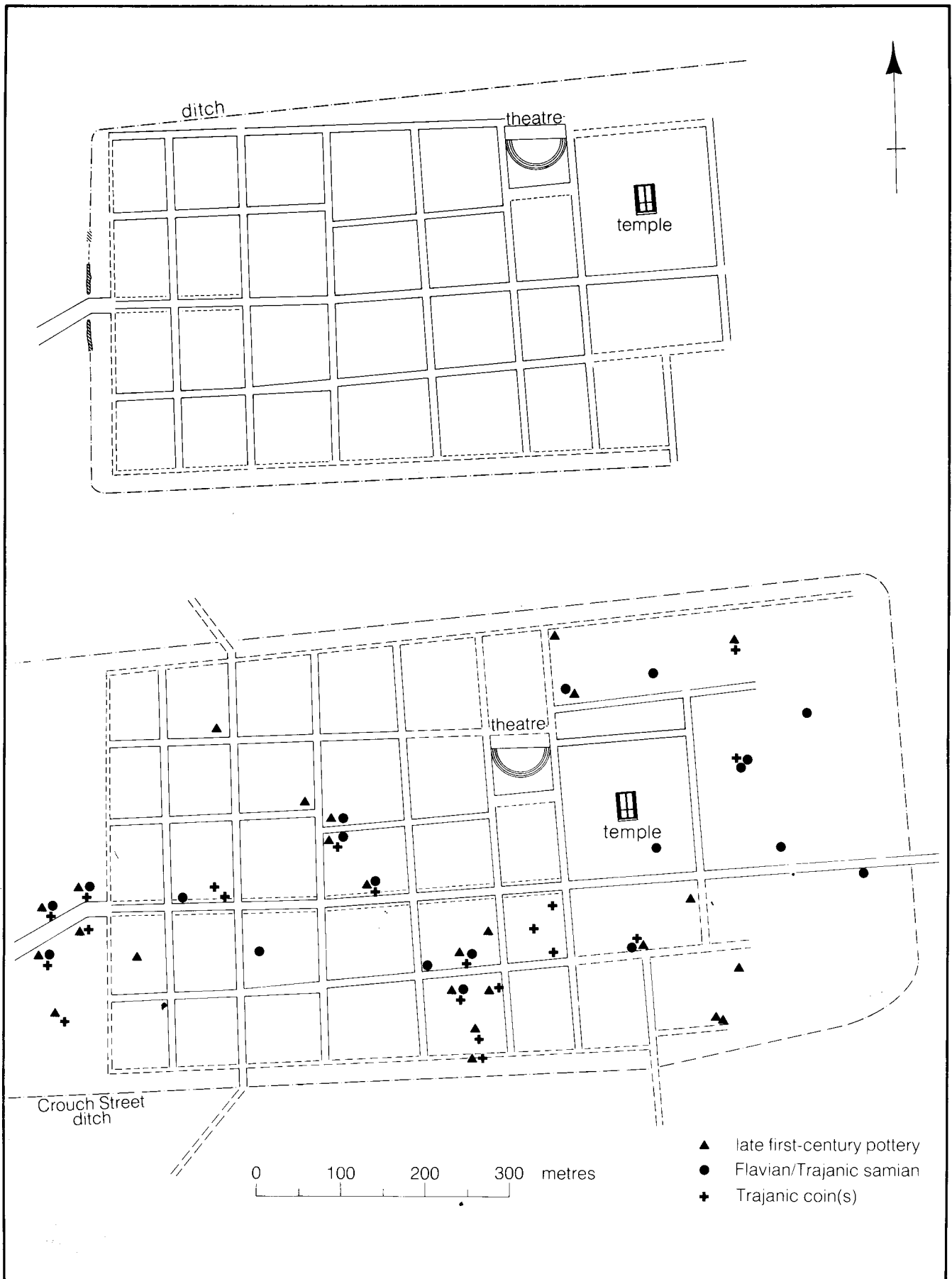


Fig 7 Above: Colchester Period 3 (AD 60/1 - c80); below: Colchester Period 4 (c AD 80-100/25). [Pages 11 - 14]

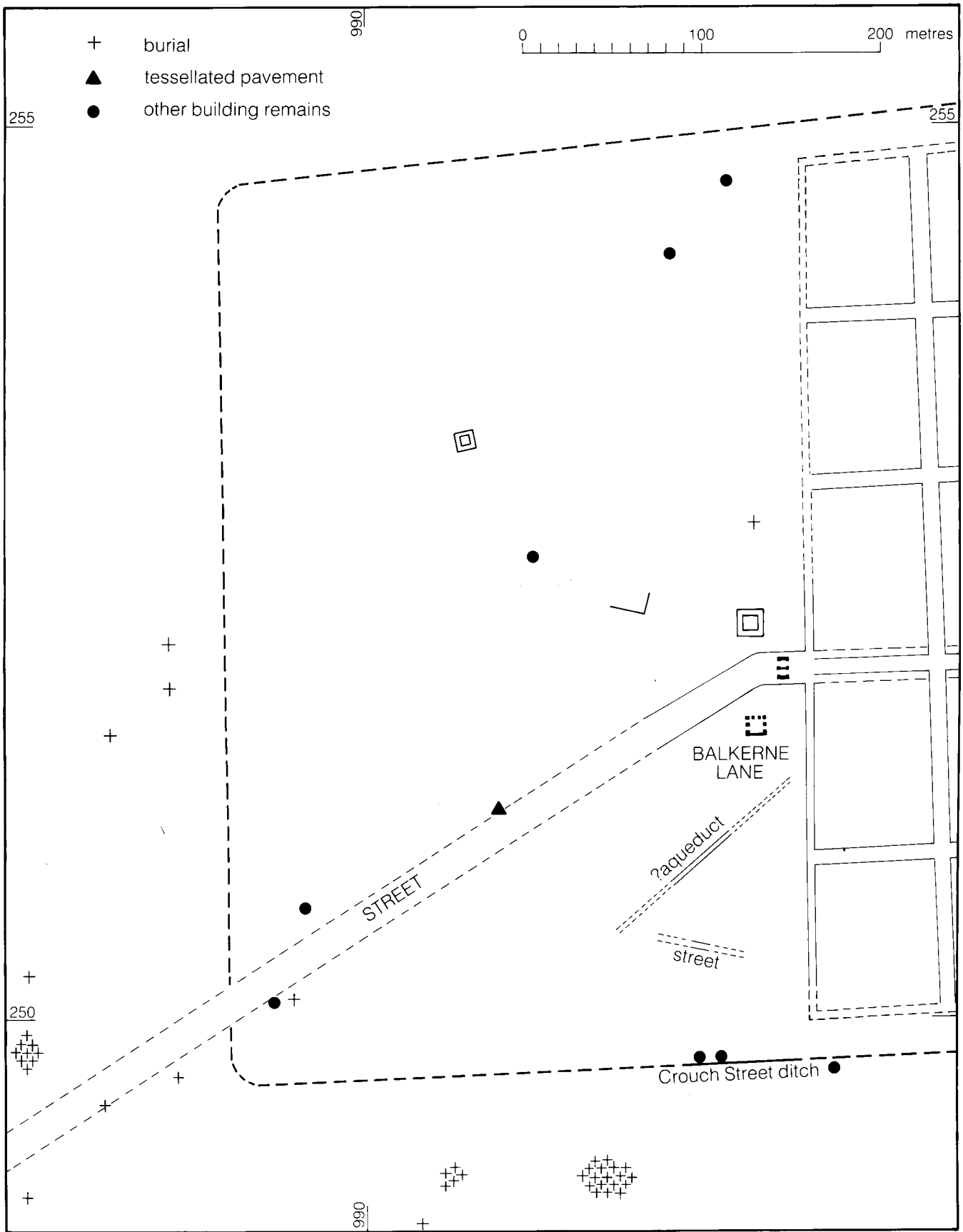


Fig 8 Colchester Period 4 (c AD 80-100/25): probable extent of western extension. [Page 11]

kiln datable to the Flavian-Trajanic period (p 182). The kiln and thus the street therefore probably predated the town wall (*see below*) showing that the defended area of the colony was probably enlarged northwards at the start of Period 4. If this conclusion is correct, then the town wall bounding the northern side of the town must have been built more or less on the site of a pre-existing rampart erected at the start of Period 4.

### The town wall and rampart (Colchester Periods 5 & 6)

The wall was of ashlar construction (Sx 62, Sheet 6a). It was between 2.7 and 3.0m wide placed centrally over a foundation 3.5 to 4.0m across. The inner and outer faces of the wall were of coursed septaria and tile which were generally set in alternating groups of four courses. The core and the foundation were both made by pouring mortar over lumps of septaria laid a layer at a time. The mortar and stone were placed directly into a large trench to make the foundation and between the two faces to form the core. The core and the faces were probably built up together; each layer in the core would have been added after the mortar in the adjacent parts of the two faces had set. The original height of the wall is not known; the highest surviving part is next to the south side of the Balkerne Gate where four groups of four tile courses (Crummy 1977, fig 17) point to a height below parapet-level of at least 4.0 m.

The rampart was not composed of the sand and soil which would be expected if it have been made from the spoil of a defensive ditch. Instead the rampart mainly contained debris from the demolition of wattle-and-daub buildings, the material being mostly crushed daub with a little domestic debris. The nature of this was quite clear from the Lion Walk section (Sx 54, Sheet 6a) and explains the 'homogeneous deposit of stiffish sandy clay with fragments of tile and small pebbles' noted by Miss Dunnett in 1967 (Dunnett 1971, 68) and 'the peculiar very dry sandy loam used in local ramparts, containing no stones' observed by Mr Hull (1958, 43). The material is typical of the demolition debris and the make-up (which is itself usually very mixed demolition debris) found all over the built-up areas of Roman Colchester and constituting most of the material which forms the deep accumulation of Roman deposits within the town centre.

There is now no doubt that the rampart was an addition to a free-standing wall; the only uncertainty rests in determining how long the wall stood before the rampart was added. The evidence for a free-standing wall came first from the 1967 and 1970 sections of Miss Dunnett (1971, 68-9) and later was confirmed by the Lion Walk section which was quite clear in this respect. Here two successive street surfaces post-dated a distinct construction-level for the wall but were sealed by the rampart (Sx 54, Sheet 6a). Moreover the nature of the material used to build the rampart supports the conclusion that the wall was at first free-standing since it implies that the debris would have come mainly from the walled area

of the colony and not a ditch. Thus not only was it possible to build up the rampart without having to bring material around or over a pre-existing wall but also for the duration of the building operation there was a convenient way of disposing of unwanted building debris. On balance, it seems possible that the wall and rampart were conceived of as a single scheme in which the building of the wall was the priority which had to be achieved before work could begin on the rampart. Probably this was done partly for the logistical reasons already explained and partly to re-establish an effective defensive circuit as quickly as possible. By leaving the rampart until later, materials for the wall could be moved easily around the circuit along a route later filled in with debris to form the bank. The whole project may have taken many decades to complete.

The date of the rampart, where this has been sectioned, seems consistently to be no earlier than c 150. There have now been eight sections across the town rampart. These are best referred to by the year of excavation: 1908 (Hull 1958, 34), 1925 (*ibid*, 42-3), 1931 (*ibid*, 54-5), 1948 (*ibid*, 46-8), 1951 (*ibid*, 25-32), 1967 & 1970 (Dunnett 1971, 68-9, fig 40) and 1972 (Sx 54 at Lion Walk, Sheet 6a). The earliest are comparatively crude in their interpretations, the best being from 1951 onwards. Where pottery has been found, a common feature to all sections is that the latest material in the ramparts (apart from 'Rampart 2' at Lion Walk which seems to be a late addition) dates to c 150. In total, there is now much pottery from the rampart and a date around the middle of the 2nd century is well established. *Terra sigillata* is plentiful and diagnostic in this respect especially from the sections of 1951 and 1972.

At Lion Walk the rampart had been built up in at least five distinct phases, the third and fourth of these being interrupted by the laying of a thin metalled surface. Despite the excavation trench being rather narrow for the purpose, it seemed as if each phase of material had been deposited in large discrete quantities each of which probably corresponded to individual cart-loads. Other sections across the rampart have provided evidence of phases within the body of it, although none so clearly as that at Lion Walk. The 1951 section had an 'upper' and a 'lower rampart' and the 1925 section had a 'second bank'. Also the work of 1967 showed that the rampart was made up of a series of 'tips' although these were not regarded as having been sufficiently independent of each other to warrant classification as separate phases.

Clearly the rampart had been built up in stages and these are detectable as variations in the material used. How long the process took cannot be judged but it may well have taken many years. Very approximately, the rampart must have contained about 25,000 cubic metres of material. If the bulk of this came from the demolition of buildings, then clearly a substantial period of time must be implied by such a large quantity. Although very speculative, it is worthwhile making a guess about how much time

might be involved. A single-storey strip-house 30 m long and 6 m wide might contain 150m of wall and thus about 75 cubic metres of daub and wall plaster. The volume of debris behind the wall might therefore represent the demolished remains of up to 400 such houses. This number would be equivalent to say about eight buildings per *insula* after allowing for extra-mural houses. In terms of area this would therefore represent up to about 50m of the total frontage of each *insula* and less than a quarter, perhaps even an eighth, of the total length of street frontages available in the colony. How much frontage was fully built up cannot be established but probably the very rough figure of 400 represents very much less than half the total number of buildings in the colony. If the average building at this time lasted about 50-100 years, then the figure of up to 400 might equal the number of demolitions which took place over a 10 to 25 year period. The figure of 400 is probably too high since there are some major unquantifiable factors which have the effect of reducing it. Larger houses and public buildings would have yielded proportionately more debris especially if their walls were thicker or higher. Similarly, not all the material used in the rampart was from demolished buildings; included was household debris and no doubt other waste materials.

In the past much has been made about the unweathered state of the inner face of the wall where this survives (sections of 1951, 1967 & 1970). Here the face is beautifully preserved so that even trowel marks in the mortar joints survive in a fresh condition. This has been taken to imply that the wall could never have been free-standing but must have been inserted in front of an earlier rampart. However the mortar used to build the wall is remarkably hard and, as proof that it is very resistant to weathering, there is a section of wall lying on one side near the Balkerne Lane site where, although the inner face lies upwards so that it is fully exposed to the elements, it is still well preserved and the trowel marks are clear and sharp. The 1875 Ordnance Survey plan shows that this part of the wall has been in its present position for over a century.

Of the earlier sections, that of 1951 stands out as being anomalous since the evidence as published in this section seems powerfully in favour of the wall and rampart being contemporary, at least in part. The pointing on the inner face was fresh, and lumps of mortar protruding at about a metre from the top of the foundation level continued as a mortar spread into the body of the rampart. The base of the inner face was irregular in profile as if the wall and rampart had been built together. However there are two points to be borne in mind when considering this section. First it was carried out where the wall crossed a steep natural slope and second the parts of the rampart and wall which seem to be contemporary are only at the bases of both features. Thus the lower part of the rampart (Hull 1958, 26, fig 6, levels 7-9) may not be part of the rampart proper but somehow may have been bound up with the wall foundation being cut into the steep slope.

The date of the wall itself is difficult to establish with any precision or certainty. At Lion Walk the latest material under the construction level of the wall was Flavian and at Balkerne Lane, because of the unusual relationship between the defences and the adjacent temples, the wall is most unlikely to be earlier than the two temples (p 111). Of the latter, the best dated is the Romano-Celtic temple which was built c 100 at the earliest.

In summary, the construction of the wall is to be placed c 100-125 with the rampart added c 150. If the wall and rampart were part of the same scheme then probably the building of the wall was nearer to 150 than 100. These dates are of course based on the dating of the latest material in each stratified context so that it is possible that they are slightly too early. How much they may be advanced is difficult to say: the coarse pottery is not much help in this respect although from the rampart there is no *terra sigillata* which has been described as late Antonine.

The gates of Roman Colchester are dealt with thoroughly by M R Hull in *Roman Colchester* (pp 16-62). There are now two revisions to his work. First the Balkerne Gate has been reinterpreted; Wheeler's Phases 1 and 2 have been reversed with the effect that what he regarded as a rebuild can now be seen as the remains of a free-standing monumental arch which predated the Balkerne Gate proper (pp 121-2). Also the 'south-west postern' (Hull 1958, 60-2) has now been discounted and was a tile drain not a gate. (A plan of this drain with its adjacent internal tower is shown here in Figures 105, p 114 and Figure 106, Sheet 5a. The excavation concerned will be described in a later volume of the *CAR* series.)

The present condition of the town wall is now better understood. In almost every place, the present ground surface is much higher inside the wall than out. Typically the surface inside might now be 2.5 m above the top of the wall foundation whereas outside it is about 1.5 m below (Sxs 54/62/55, Sheet 6a). This means that for much of the circuit the base of the foundation is well above the ground level outside the wall and explains how it was possible for two sections of wall to fall on to Balkerne Hill last century (Hull 1958, 22). The build-up inside the wall is a result of two factors: the steady rise in the ground level which took place across the whole town in the Roman period and the deep accumulation of dark topsoil which characterizes the medieval and later deposits well back from the street frontages of post-Roman Colchester. This is in contrast to outside the wall where erosion into the town ditch caused the ground level to drop. The discrepancy between the two levels is less at the gates than elsewhere. This is because in these places the presence of a street combined with the absence of a ditch has minimised any differences between the two. This effect is most marked at the Balkerne Gate.

For most of its circuit, all that can be seen of the wall today is the core with some fragmentary traces of the inner ends of the tile courses. The outer face of the wall is missing except at the sections to either side of



the Balkerne Gate. Clearly the outer face has been extensively robbed because too much is missing to be the result of weathering and erosion alone. There is a clue as to when this robbing took place. The excavation of the bastion at Lion Walk showed that the adjacent wall had been refaced when the bastion was built c 1375-1425 so that the robbing of the outer face must have been removed before then (p84).

**The later development of the colony (Colchester Periods 5c & 6)**

During the last quarter of the 3rd century (in Colchester Period 5c), the colony was taking considerable trouble to maintain and improve its defences since about this time the town ditch appears to have been widened and a counterscarp bank added. These alterations were the town's response to the troubles within the empire during the late 3rd century. Certainly from c 300 or later (the start of Period 6) until the end of the Roman town in the 5th century, there are clear signs that the settlement feared military assault and that these fears were substantial enough to demand major sacrifices. The

suburbs dwindled as families moved to new homes within the security of the walls and the town braced itself for siege. The Balkerne Gate was closed, the town ditch extended to cross in front of it and the traffic diverted probably through Head Gate (Fig 9). A similar fate may have overcome Duncan's Gate in the north-east part of the town. And to judge from Hull's excavation of this gate, the colony was attacked on at least two occasions (Hull 1958, 40).

With the building of the town wall in the 2nd century, the topography of the colony underwent no further major changes apart from in the suburbs which seemed have suffered a dramatic and sudden decline almost to the point of disappearing c 300 or later. There were two principal areas of extra-mural settlement. The larger of these lay on the west side of the colony and included the Balkerne Lane site whilst the other was to the north of the North Gate and was discovered as a result of recent excavations at Middleborough. The north suburb may have extended across the river Colne to include the one or more buildings known to have existed in the vicinity of the Victoria Inn (*ibid*, 240-1). There were several Roman buildings outside the South Gate (*ibid*, 244-5) but, to judge from the distribution of known Roman

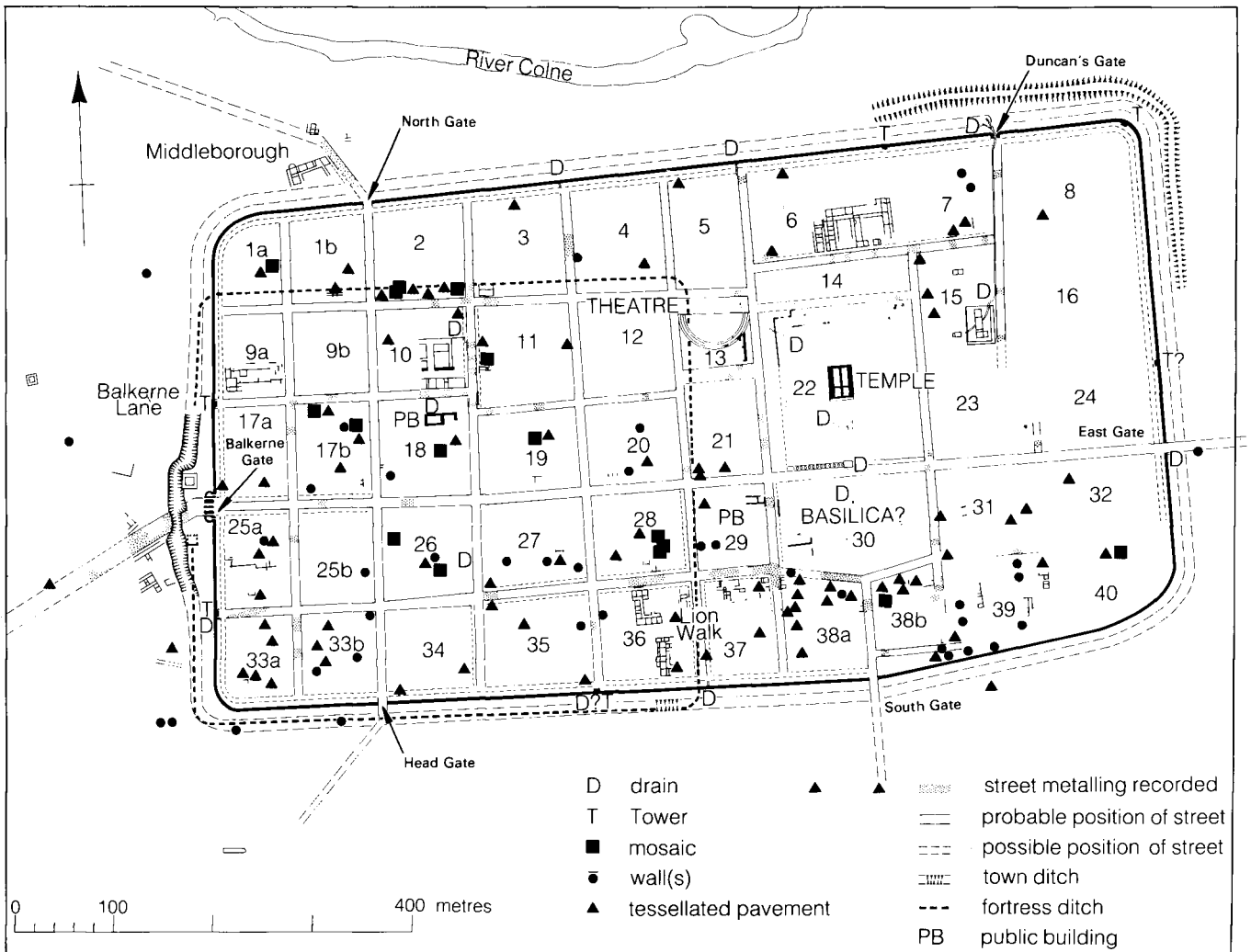


Fig 9 Colchester Periods 5 and 6. [Pages 11-20]

burials (*ibid*,255-6), these may not have been part of a suburb of any size. No additions or improvements to the town wall have been detected (the bastions on the south side are medieval — see p84) although sometime after 250 the rampart was heightened (p73).

With the demolition of the houses at Balcerne Lane and Middleborough, the principal phases of occupation at both sites seem to have ended in about 300. The dating evidence comes principally from coins backed up by pottery. At Middleborough there is a marked paucity of 4th-century coins which is very apparent when the coins from the site are compared in the form of histograms with those from Lion Walk and Balcerne Lane (Fig 10). The shape of the Middleborough histogram is similar to those of Lion Walk and Balcerne Lane up to the range 330-45 shortly before which there is a very marked drop in numbers, despite there having been a bias in the excavation towards the examination of the latest levels. The total number of coins recovered from Middleborough is low (81) so that the number of coins to be expected within the critical range of 294-330, even under normal circumstances (5% at Lion Walk

and Balcerne Lane), is too small to be helpful. Thus the most that can be deduced about the date of the demolition of the houses at Middleborough is that it probably occurred between 290 and 330.

At Balcerne Lane a large deposit of dumped soil sealed allotments or gardens at the southern end of the site. This material almost certainly derived from the widening of the adjacent town ditch and seems to have been used to form a counterscarp bank. Fortunately the bank and the cultivated soil which it sealed contained much dating evidence. This is set out later (pp140-1) where it is concluded that a date of within the range 276-285 is possible for the widening of the ditch. Perhaps of significance here is the absence of barbarous radiates dated 270-90. This is in contrast to the Middleborough site where these occur in equal proportion to coins within the range 260-73. The dating of the barbarous radiates presents problems (see note by Dr R Reece on p 141) but their absence in and under the bank is consistent with the conclusion that the demolition of the buildings at Middleborough occurred some years after the widening of the town ditch. Certainly the decline at Balcerne Lane was probably not a direct

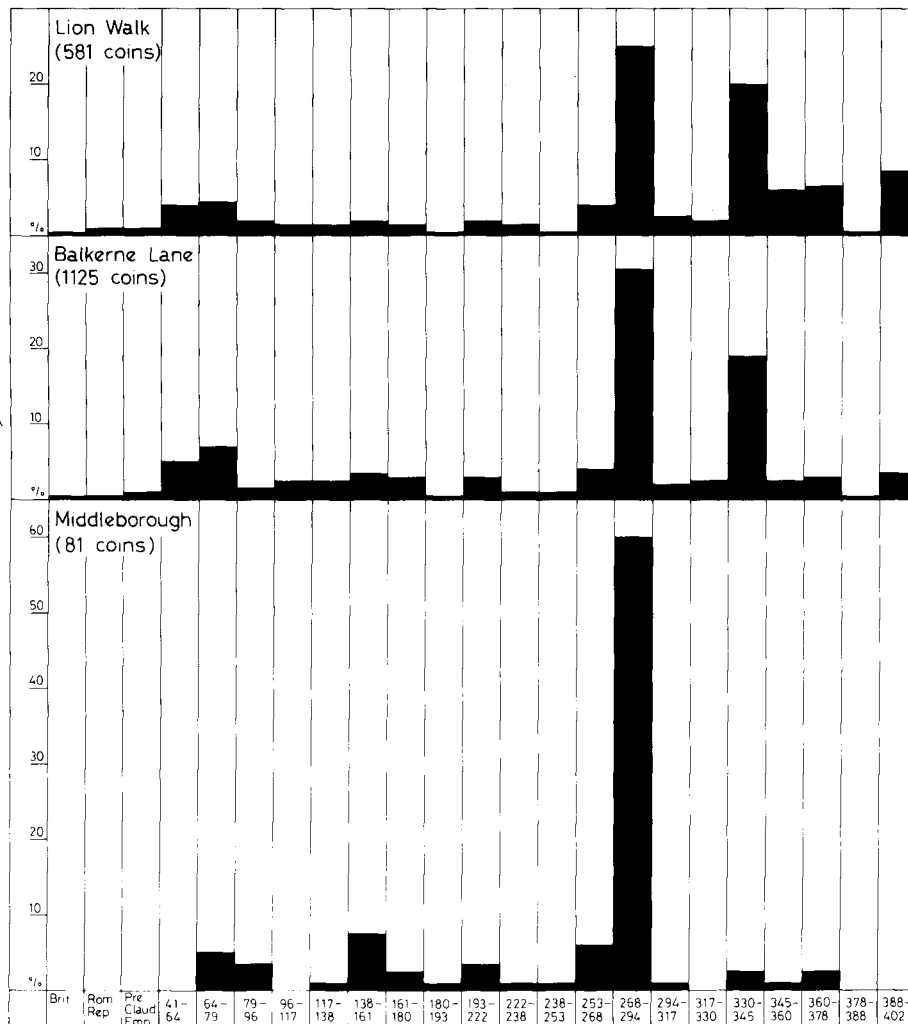


Fig 10 Histograms of coins from the Lion Walk, Balcerne Lane, and Middleborough sites. [Page 17]

result of this operation but instead happened about the time when access into the town via the Balkerne Gate was lost. This occurred when the street was cut through and the butt ends of the town ditch were joined up to make the ditch continuous along the west side of the colony. The shape of the ditch in its extended form seems to indicate that this act was later than the widening operation (p 145) and the pottery and other finds associated with the end of the buildings (Buildings 54-8 & 64-5) point roughly to a date of around the late 3rd and early 4th centuries. Thus it is quite probable that the demolition work at Middleborough and Balkerne Lane were contemporary and were associated with major alterations to the defences which resulted in the closure of at least one of the town's gates. The precise relationship between the decline of the suburbs and the defensive changes referred to is obscure, partly because the dating evidence for the digging of the stretch of ditch across the street at Balkerne Lane is limited. Conceivably fear of disaster could have resulted in movement from the suburbs to the walled area of the town which left the suburbs much depleted and thus set the scene for a relatively painless tightening of the defences; alternatively the defensive changes themselves may have precipitated the suburban decline. In the latter case, the suburbs with restricted access to the town centre would have become inconvenient places in which to live or, much more likely, being outside the defensive circuit would have been regarded as being too vulnerable to attack. There is no reason to suppose that the demolition work at Middleborough and Balkerne Lane was undertaken as a coordinated scheme; it is more probable that, as the owners moved into houses within the walls, the buildings in these areas were demolished one by one without replacement.

The histogram of the 4th-century coins at Balkerne Lane, unlike Middleborough, compares well with that of Lion Walk despite the houses at Balkerne Lane having been demolished about 300. The reason for this is because there was still considerable activity in the Balkerne Lane area in the late Roman period and most of the late coins were found in the town ditch of Periods 5 and 6. The two temples survived well into the 4th century (albeit the Romano-Celtic temple was much modified, p 125) and to the north and south of the main street there was much pit digging and probably dumping of debris. This is in contrast to the Middleborough site where there appears to have been no Roman activity of any substance after the demolition of the buildings.

Unfortunately it is not known whether or not the ditch at the North Gate was extended to cut across the face of the gate as at Balkerne Lane. However Duncan's Gate, which lies about 650m to the east, may have been cut off in the Roman period. Until the 1970s there was a low counterscarp bank which lay on the north side of the town ditch north-east of Duncan's Gate (Fig 9). When the bank was destroyed in the early 1970s, the outline of the ditch was very clear and could be seen to stop short of the gate. According

to the OS maps of 1875-6 and later (Hull 1958, pl 41), the bank originally continued westwards across the face of the gate so that, although the street which must have led from the gate does not appear to have been cut by the ditch, it nevertheless seems to have been blocked. The western end of the bank was removed in 1935 and large quantities of Roman objects came to light. Mixed with this material were many jumbled human bones (Hull 1958, 257; *CMR* 1944, 16). To the east the base of the bank was examined during the course of a small excavation in 1978 when more mixed up human bone was found. Hull refers to the soil excavated in 1935 as being from the outer lip of the ditch although according to the OS maps it must have been a bank. Hull states that three feet of the ditch were removed. This is about the depth of the dumped soil at Balkerne Lane and no doubt was in reality the full height of the surviving bank. In 1935, the intention was to produce a level site for a bowling green. Thus the removal of a bank is understandable whereas digging out the top of the ditch is not. The explanation for the jumbled human bone is not clear but probably there was an inhumation cemetery on the northern edge of the original ditch. When the ditch was widened, the most southerly burials must have been dug up and redeposited in the newly formed counterscarp bank.

Duncan's Gate itself is a site of great importance not only in relation to what was happening in the suburbs but also to the end of Roman Colchester itself since the gate appears to contain evidence of at least two destructive fires of 4th-century or later date. The gate was not reused after the end of the Roman period and its site lay in a quiet area of the medieval and later town so that, apart from the effects of stone robbers and archaeologists, the gate is still very well preserved. Most important is the survival of much of the stratification. Duncan's Gate has been excavated twice, once in 1853 by Dr P M Duncan who discovered the gate and again in 1927-9 by M R Hull. Despite the inevitable limitations in the standards of their excavations and interpretation, both excavators talk of evidence of fire. Duncan's account hints at over-enthusiastic interpretation: '...human bones, horse bones, much charred wood....large pieces of burned fatty material, in contact with charred wood, of disagreeable import....weapons, large human bones and lumps of semi-vitrified substance' (Duncan 1858, 220, 222). Hull's work confirmed the presence of burnt remains but was more discerning in its assessment. Two successive fires were detected, the earlier sealing a 4th-century coin. Over a metallised surface was a continuous layer of charcoal 1 in. thick'. On top of this was a layer of metalling about 6 in. thick over which was a 'thin layer of greyish mud' which sounds like road silt. Hull wrote that over this were 'traces of an intense conflagration. The charcoal (associated with the latter) included large pieces of oak and lay from 2 to 4 in. thick. At the bottom remains of planks about 7 in. wide could be traced, lying north and south, and the bulk of the charcoal above them was of small, round brushwood. Had brushwood been piled against a gate or barricade and fired, and the whole mass fallen

inwards, the result would be exactly as found..... The two burnt floors are only present in the gateway.....the heat of the last fire had turned the stones red' (Hull 1958, 40). None of the human and other remains mentioned by Duncan were found. Hull went on to observe that, 'This may be the best evidence we shall see of the end of Roman Colchester. It is unfortunate that all the ground above this level had been disturbed, either by Duncan or the builders of the brick wall which closed the gate. We cannot say whether more layers ever existed, or whether we actually had here the very last level of the Roman period.' The fact that there were two fires shows that evidence of a fire itself does not necessarily imply the end of the Roman administration since clearly the town must have survived the assault which caused the first one (if indeed an assault was the cause). On the other hand the fact that so much of the debris from the second fire was not cleared away must make us wonder whether this truly does point to a dramatic end to Roman Colchester. It is a great pity that there is not better dating evidence for the burnt layers at Duncan's Gate. The bronze coin mentioned by Hull was illegible but he stated that it apparently had a diademed head and was 'undoubtedly of 4th-century date' (*ibid*, 40). Diademed heads occur on bronze coins from 307 onwards although they are rare as site finds until 330-45 (cf Fig 10). Thus the fires at Duncan's Gate were probably later than 330 in which case the fires would have post-dated the decline of the suburbs perhaps by some considerable time.

The possibility of Saxon raids along the east coast appears to have been regarded as a serious problem around the period 268-282 (Frere 1974, 188) and consequently precipitated major improvements to the coastal defences in the south-east of England. Two forts in the system, Bradwell-on-Sea and Walton Castle, lie near Colchester and, although the dates of their construction are not known, it is thought that these probably belonged to the period 276-85 (Johnson 1976, 109; Cunliffe 1977a, 5-6). There is thus an obvious historical context for the widening of the town ditch at about this time. Colchester lies less than ten miles from the east coast and, although protected to an extent by these two forts, the town would have been vulnerable to sea-borne raiders especially via the mouth of the river Colne. Thus given that the danger from the Saxons was perceived as being great enough to warrant the building of these and other forts, improvements to the town defences at the same time seem an obvious precaution.

Tantalizingly, one of the latest buildings found at Balkerne Lane (Building 55) had been destroyed by fire probably during the early 4th century (the end of Period 5) and was not replaced. Of course accidental fires must have been commonplace but there is no doubt of the possibility that the building was destroyed during a Saxon raid on the town.

By the second decade of the 4th century, the problem posed by the Saxon raids seems to have eased. Little is known about their subsequent frequency and severity until the disaster of 367 although it is thought that until this time the raids were comparatively light. Thus the decline of the suburbs at Colchester, dated as we

have seen by archaeological means to within the period c 290-330, and the tightening of its defences by the sacrifice of one or more gates can probably be placed more accurately within the range c 290-310 (ie c 300). The coin with the diademed head from Duncan's Gate is too late to fall with the initial phase of Saxon raiding and suggests that the first of the fires at the gate probably did not occur until 367 or later.

Inside the walled area of the town, several buildings were demolished without replacement. At Lion Walk, Buildings 20 and 22 were knocked down c 300 and 350 respectively. That these were deliberately demolished is made clear from the thick layer of crushed daub and wall plaster which sealed their floors (p 70). This is in contrast to Buildings 19, 24 and 25 all of which had been abandoned and left to decay. On the floors of these buildings broken roof tiles lay horizontally in an accumulation of topsoil. The absence of daub and plaster on their floors indicates that the buildings had been left to decay; their walls were still standing and their roofs were still in place whilst their floors became overgrown. There appears to have been some robbing of the remains since none of the tiles were whole and the quantities which survived were only small fractions of what would have been required to cover the roofs concerned. The robbing probably took place in early Anglo-Saxon times.

A decline in the suburbs might be expected to be matched by an increase in the numbers of houses within the defended area of the town. However there is as yet no indication that this is true. On the contrary, Buildings 20 and 22 were not replaced and their plots appear to have remained vacant for the rest of the Roman period suggesting that there was no shortage of suitable building plots in late Roman Colchester.

The date of the end of the Roman town is not clear. Most important in this respect are the earlier of the two huts found at Lion Walk (Hut 2) and two early cruciform brooches found just outside the town walls. These are discussed at length in *CAR 1* (5-6 & 10-11 resp) where it is suggested that these remains indicate that Colchester had succumbed to Saxon pressure by c 440-50 (*CAR 1*, 22-3).

## Extent of the colony

The town-zone of the colony is likely to have consisted of the gridded area and possibly the main cemeteries. Most of its boundaries had originally been established by force as the limits of the military base. The exception is the north boundary which as previously explained (p 11) seems to have been relocated nearer the river in the late 1st or early 2nd century.

The western limit of *Colonia Victricensis* was probably the monumental arch at Balkerne Lane and the adjacent sequence of town defences since so often arches like this marked boundaries (eg Verulamium). Thus the buildings excavated at Balkerne Lane, lying outside the demarcated city, will have had a similar status to the colony as the *canabae* to a legionary fortress, namely as an external

settlement subject to and clearly subservient to the newly established *colonia*. Moreover some of the earliest civilian buildings (Buildings 44-6) at Balkerne Lane, although well-built, were of a less robust standard of construction than contemporary buildings found so far within the main area of the town (p 23). This is in keeping with the notion that this area was of a lower status than elsewhere in the colony on which it was dependent. Also the location of the Romano-Celtic temple at Balkerne Lane is probably significant in this respect and indicates that the area was held by natives or at least people without Roman citizenship, rather than by colonists. The temple is one of seven such buildings now known at Colchester. Although distributed across the native settlement, none of these buildings lies within the walled area of the Roman town. By contrast the latter contained within its walls the Temple of Claudius which was a classical temple of the Imperial Cult. There thus appears to have been a dichotomy in which Romano-Celtic temples were preferred by the native population and the classical type was favoured by the colonists. The position of the Romano-Celtic temple at Balkerne Lane is consistent with this supposition since it stood on land which was held on a different legal basis to that within the gridded part of the colony.

In the early 3rd century, any surviving legal distinction between the native and the colonial populations at Colchester would have disappeared as a result of the edict of Caracalla in which Roman citizenship was granted to all free subjects of the Roman empire. Hence by then the stage was set for a decline of the town's suburbs since in effect those living outside the gridded area would presumably have been free to take up residence anywhere inside the colony.

## Building methods

### Building materials

The commonest materials were timber (mainly oak), septaria (calcareous, clay concretions found along the Essex and Suffolk coast; Williams 1971), greensand (Kentish rag and associated stone), tile of various sorts, chalk for mortar and plaster, sand, gravel and 'daub'. The last of these was sandy clay loam which was used to infill and coat the surfaces of timber-framed walls. It was also used to make floors and sun-dried blocks or slabs for building. Rather than refer to this material throughout the following report by the cumbersome description 'sandy clay loam', the term 'daub' will be used although this is not satisfactory since the name could be taken to imply that the material was always meant to be applied as a daub which it often was not.

### Foundations

These were not widely used in house building until the 2nd century. The Roman builder was usually careful to place his walls directly on the natural sand because he recognised this as having load-bearing qualities of a good and uniform nature and thus avoided any subsidence or uneven

settlement. This was easy to do during the early years of the colony because at that time the natural sand was not far below the surface of the ground. However by the end of the 1st century, there was a considerable build-up of earlier floor levels and destruction layers so that the later builders were forced to use foundations. These were dug to penetrate the build-up and reach the underlying sand. By this means the load on each wall could be transmitted through its foundation to bear on the natural and thus avoid any differential settlement. Hence the depth of a foundation was not indicative of the load it had to bear but was a reflection of the depth of build-up of earlier levels.

The earliest foundations were usually of packed gravel (Building 16) or rammed unmortared rubble (eg Buildings 13 & 18). From about the middle of the 2nd century, foundations made with alternating layers of stone and mortar seem to have become the commonest type. A late and unusual example of foundation was found at Building 19 where lumps of septaria were set not in mortar but in daub. A building technique which occurred in the Flavian period and possibly later was the use of small gravel- or rubble-packed bases (Buildings 17 & 54). The most obvious explanation for these is that they were supports for wooden posts. However the bases do not occur at regular intervals and thus their precise purpose is unclear.

Characteristic of many of the buildings of the fortress was the use of shallow mortared plinths (*opus caementicium*; Fig 11). Wherever these have been found, they have proved to have been early and indicative of a military building. These plinths or dwarf walls were formed by pouring a mixture of small stones and sandy yellow mortar into upright wooden shuttering and then tamping and smoothing the upper surface to leave it neat and flat. The stones were water-worn pebbles with small quantities of septaria. The plinths were 0.60 to 0.85 m wide and stood 0.15 to 0.18 m above the contemporary ground level. The lowest parts penetrated the natural sand by 0.05 to 0.08 m and were in effect foundations. No construction-trenches were detected although the boards which formed the shuttering would have been inserted a few centimetres into the natural sand (or at least what the builders took for natural sand). Most significant is the absence of tile even as small fragments thus showing that the plinths were built before tile was being made locally.

Construction-trenches are rare in Colchester. These were only required where the foundation was to be built as a free-standing structure within its trench as opposed to a foundation formed by completely filling in a trench with rubble and mortar. In Colchester construction-trenches only appear to have been used during the building of cellars (Buildings 22 & 56).

### Wooden piles

Piles occurred under the foundations of a possible shrine at Balkerne Lane (Building 53), a house at Lion Walk (Building 25), a building of uncertain purpose at

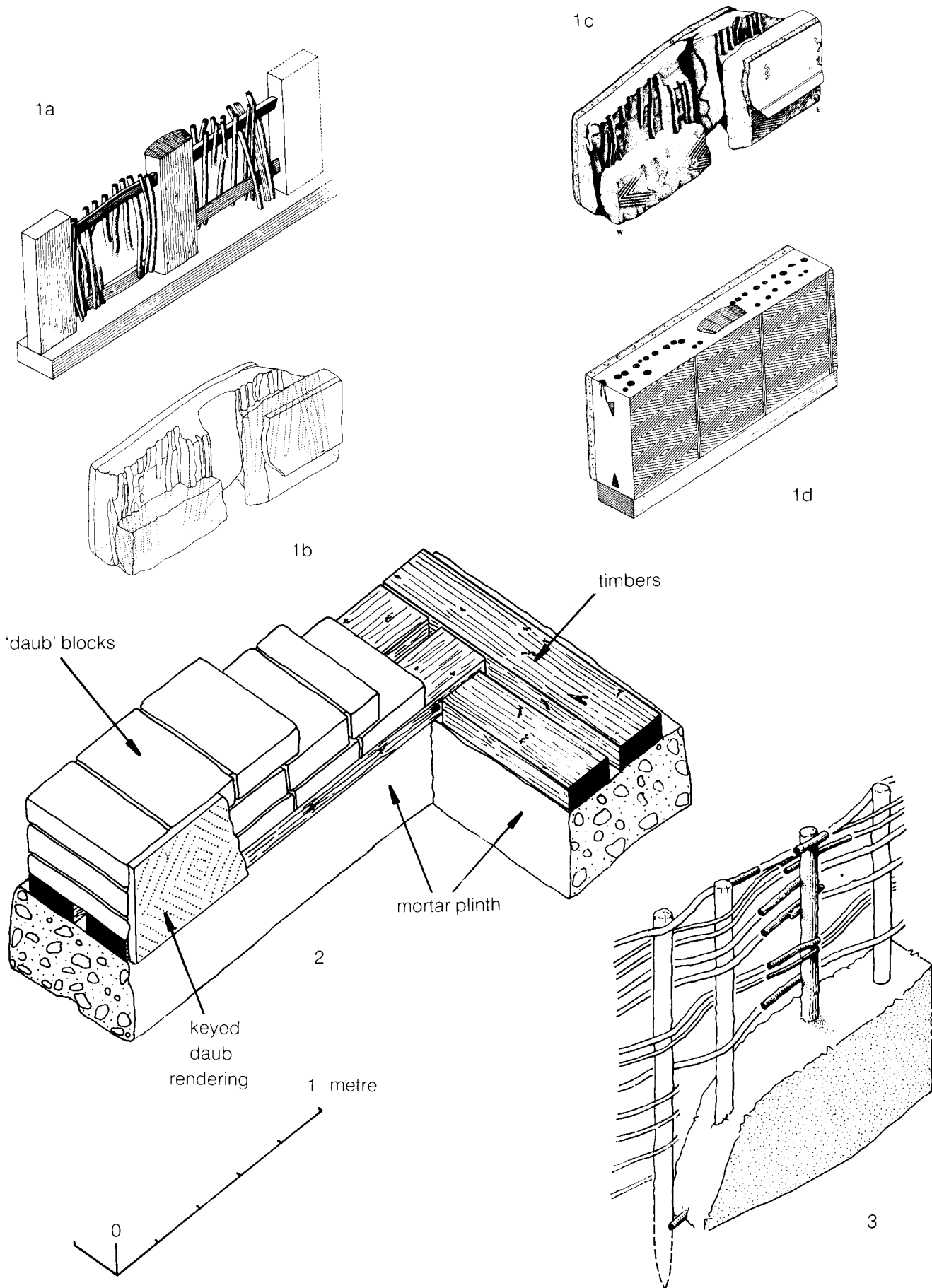


Fig 11 Types of wall: 1...stud-and-wattle (LWC JF312), 2...daub block (Culver Street, BF487), and 3...stake-and-wattle (BKC J, north wall of Building 44). [Pages 20-3]

the foot of Balkerne Hill (Building 66), and the basilica (possibly Christian) found in 1981 at Culver Street (Roman Britain 1981, *Britannia*, 13, 371). The building at the foot of Balkerne Hill was in a waterlogged area and consequently the piles were perfectly preserved (p 146). The other sites where piles had been employed were not waterlogged and clearly could never have been so. In the case of the possible shrine, the builders must have felt that it needed extra stabilization because the structure was probably rather top heavy and it lacked strip foundations around three of its sides. The piles at Culver Street and Lion Walk were under shallow foundations and had been driven through the underlying build-up of Roman deposits. They were probably intended as a cheap and less arduous alternative to constructing foundations through what, by the 3rd century or so, had become a substantial accumulation of earlier levels. The piles of the basilica at Culver Street were large and numerous. They were up to 2 m long and occurred not only under the outer walls of the building but also under the columns or piers which formed the aisles. By comparison, the Lion Walk example is extremely modest both in scale and in the number of piles used. However the circumstances at Lion Walk and Culver Street are the same in all respects.

### Types of wall

Five types can be recognised. These are as follows.

#### *Stud-and-wattle walls* (Fig 11.1)

This type of wall is fully-framed with well-cut timber of rectangular or square section. Upright studs were set about 0.4 m apart on top of a ground-plate. At first the ground-plates were set directly on the surface until in the 2nd century and later these were laid on rubble or mortared foundations. By analogy with the framing of 15th- and 16th-century houses of south-east England (which this type closely resembled), the studs would have been fitted to a top-plate and wind-braced with diagonal members. The panels between the studs were filled with wattles and, with the use of a float, the complete frame was encased in daub so that outer faces of the studs were covered with about 50 mm of daub. This type of wall occurs before AD 60 at Lion Walk although its use in the military period is yet to be proved. Possibly it may be exclusively civilian in context (pp37 & 40). Structurally, stud-and-wattle walls were very strong and probably were intended to support tiled roofs which by their nature would have been much heavier than thatch. Building 8 at Lion Walk contained several walls of this type and, from the large quantities of broken tile in the demolition debris, clearly had a tiled roof.

#### *Daub-block walls* (Fig 11.2)

Daub-block walls appear to have had no upright studs and instead were built entirely from blocks of sun-dried 'daub' laid on a single or double ground-plate. The base of an internal wall of this type (JF420) was

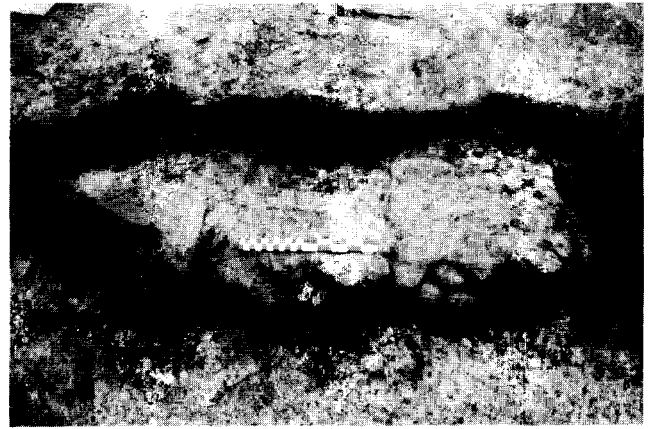


Fig 12 The burnt daub-block wall JF420 from Building 8 at Lion Walk. [Pages 22 & 40]

found *in situ* at Lion Walk. It had been burnt during the Boudican revolt and blocks about 300 mm (1 *pes monetalis*) across overlay a pair of ground-plates (Fig 12). Loose blocks were discovered elsewhere (Building 10 & pit LWC BF144) which, because they had been burnt in AD 60/1, were hard and retained their shape. One of these blocks was complete and measured about 185 x 222 x 95 mm. Unlike the blocks *in situ*, this had been tempered with chopped vegetable matter. Large blocks were used in the superstructure of the military buildings. Although none of these blocks were found at Lion Walk, a large part of an early wall was discovered *in situ* at the Culver Street excavation in 1981. The wall is illustrated here (Fig 11). The blocks measured 430 x 290 x 90 mm (1.5 *pm* x 1 *pm* x 5 digits) and lay on a double ground-plate. This in turn was set on a mortared plinth about 300 mm high which penetrated the original ground-surface by no more than a few centimetres. The wall, which had been destroyed in 60/1, was part of a military barrack block and was of the type characteristic of the Colchester barracks generally. From a load-bearing point of view, this kind of wall would probably not have been as strong as the stud-and-wattle variety and it is not clear whether these would have been substantial enough to have supported a tiled roof. The daub blocks were similar to the blocks in the revetments of the military ramparts. Both types seem to have been made from the same kind of material. However the blocks in the rampart were less regular in shape than those used in walls and they do not contain any tempering matter. Block walls were first recognised on North Hill (Dunnett 1967, 31, pls 3 & 4).

The remains on the sites do not usually allow the daub-block type of wall to be distinguished from the stud-and-wattle variety. This is because for both types only traces of the ground-plates survive. Building 55 at Balkerne Lane provides the latest example known of a Roman structure incorporating ground-plates in Colchester but the precise type of construction involved is not clear. The profile of some foundations indicates that these were built to carry ground-plates (Building 59) whilst others were wide with flat tops as if for the wider daub-block type of wall (Building 19).

### *Stake-and-wattle walls* (Fig 11.3)

This kind of wall has been recognised only at Balkerne Lane in Buildings 44-6. The walls were formed by hammering stakes into the ground at about 300 mm (1 *pm*) intervals, weaving horizontal wattles around them and encasing the resulting structure with daub. None of the walls showed any evidence of having been keyed or plastered. Their comparatively light construction suggests that this kind of wall was intended for use with thatched roofs. No tile fragments were found in the destruction debris to suggest otherwise.

### *Post-in-trench walls*

The type of construction in which walls were formed by dropping posts into continuous trenches is rare in Colchester. Two, possibly three, examples can be cited; one was in a pre-Boudican civilian context (Building 45, Room 6) and the others in the fortress (the possible tribunes' houses at Culver Street and perhaps Building 5 at Lion Walk).

### *Mortared walls*

Although it is very rare for parts of walls to survive *in situ* (except in the Boudican destruction debris), the overwhelming evidence is that the walls of houses in Colchester throughout the Roman period were always of daub, not stone and tile. This is shown by the frequent occurrence of layers of daub on top of the latest floors of houses of all periods. These layers very often contain much crushed painted wall plaster and thus clearly derived from the demolition of walls. There are two exceptions both of which are cellars with walls of coursed septaria and tile (Buildings 22 & 65). One of these (Building 22) had at least one wall which continued in its mortared form above ground-level. Mortared walls must have been very uncommon in the 1st century and occurred if at all only in public buildings. The best known example of a 1st-century public building is the Temple of Claudius although even here it is possible that the superstructure above podium level was mainly of daub. Certainly at least one of the town's Romano-Celtic temples had a timber-framed superstructure (Temple 5; Crummy 1980a, 256) and it may be that even in public buildings mortared walls were rare. The fact that their foundations could be wider than those used for houses does not necessarily mean that the walls themselves were of mortared stone and tile since by its nature the daub-block type of wall could be any width.

### *Boarded walls*

This type of wall was made by nailing planks horizontally to timber studwork. Only two examples of boarded walls have been found both of which were in cellars. One, in Building 56, was of 3rd- or early 4th-century date and the other was discovered on the Sheepen site in 1970 (Dunnett forthcoming).

### **Keying**

Considerable quantities of keyed daub have survived in Boudican destruction debris especially at Building

8 where the keying was elaborate. Here the surfaces were keyed with bands of diagonal lines separated by horizontal string marks above a dado of continuous upright panels of lozenges 280 mm wide (Fig 13.1 & 13.5). The strokes in the diagonal bands were made individually with a pointed tool such as a small trowel. String had been held horizontally and pressed into the damp daub perhaps by running a finger along it. The dado effect was probably formed with a roller or a stamp (the latter being less likely because of the considerable pressure required), although carved shuttering could have produced the same effect. Three impressions of string were detected. These were parallel and were 110 mm and 145 mm apart. Elsewhere some bands of diagonal lines had been separated by deep grooves (Fig 13.2 & 13.6). Other fragments of daub showed a mixture of the chevron pattern and scored hatching as if these pieces occurred near the top of the dado (Fig 13.3 & 13.4). The dado was preserved *in situ* in wall JF312 of Building 8 where it stood to a height of 0.38 m above the floor (p40).

It is hard to believe that the finished pattern was purely functional; it must have been meant to be seen. Perhaps the walls needed a long time to dry out before they could be plastered and therefore to make life more tolerable for the building's occupants the keying was made decorative. Alternatively, the plastering of the walls may have been regarded as an optional extra which could be undertaken at a later date if required.

### **Floors**

Until the 2nd century, floors in houses were usually of 'daub'. Whether this was laid down deliberately or whether it was simply residue left over from the demolition of the previous phase or the construction of the new is not clear. Left-over demolition debris seems the most likely explanation since frequently natural sand formed the earliest floors. Also the daub in floors seems mainly if not entirely to have derived from the demolition of daub walls or in some rare cases the digging up of daub floors. Proof of this is provided by the frequent occurrence in the daub of crushed wall plaster and occasionally redeposited occupation (Sxs 32 & 40, microfiche). Unlike mortar and paved floors, those of daub or sand could not be swept clean and as a result one or more layers of very fine grey soil accumulated over them. Sometimes this was very thin and barely visible in section (eg Sx 72, Sheet 6b) whereas in rooms where there were hearths or ovens, the occupation could accumulate to a depth of 0.2 m or more (Sx 52, microfiche).

Evidence for timber floors is rare and limited to one example at the Culver Street site, another in the cellar of Building 22 at Lion Walk, a third in a 1st-century cellar at the Cups Hotel site (excavated 1972; details in a future volume of *CAR*), and a fourth at Balkerne Lane where severe settlement led to the preservation of traces of floor joists in Building 47. It is possible that, because they are difficult to detect, timber floors were much commoner than it appears. Plain mortar floors first occurred in houses of the early 2nd



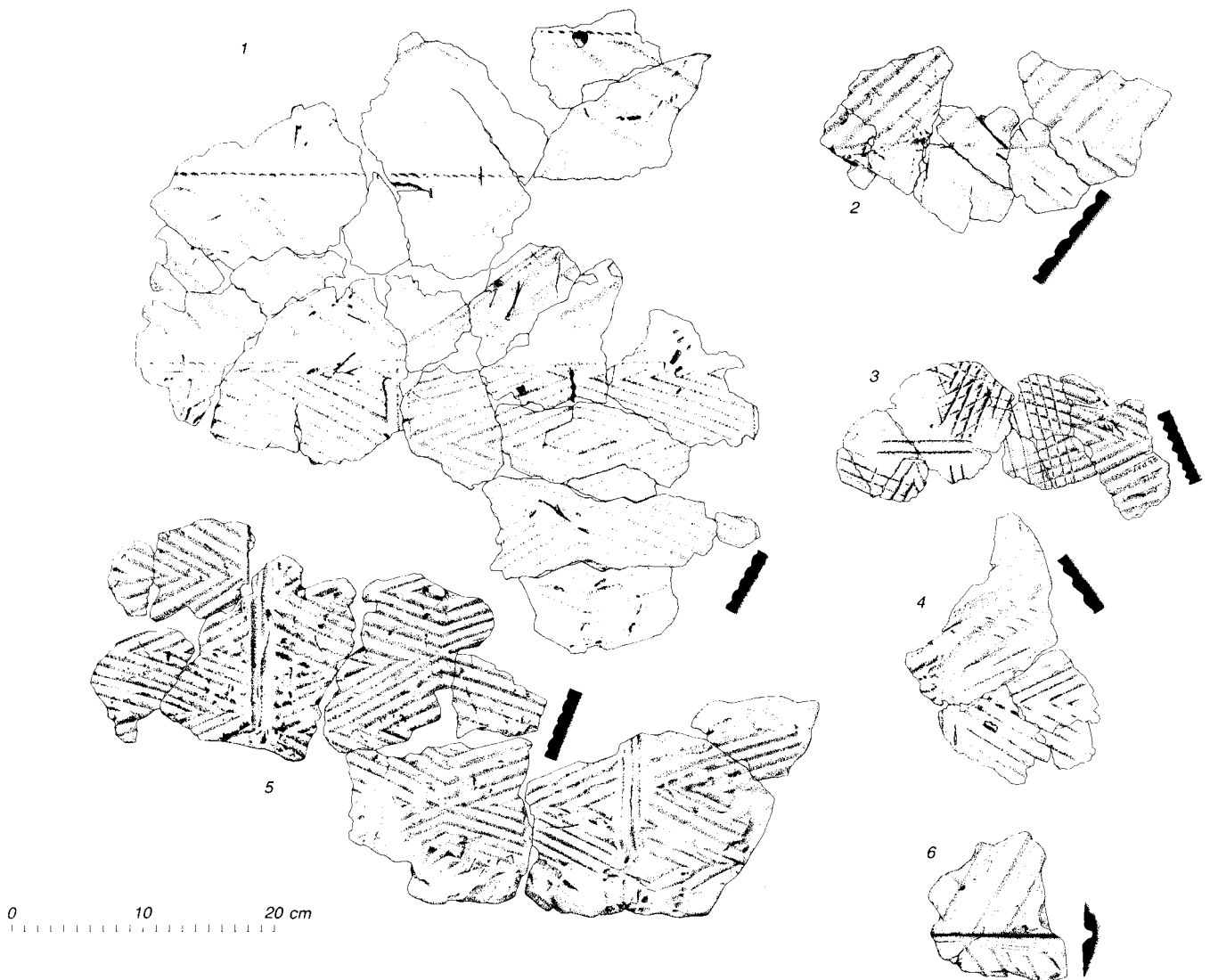


Fig 13 Pre-Boudican keyed daub from Building 8 at Lion Walk. [Page 23]

century, the earliest example known being in Building 69 at Middleborough. The first mosaics and plain tessellated pavements seem to appear soon after.

### Tiles, bricks, and window glass

Descriptions of the types of tile and brick found during the main excavations of the 1970s are given in Appendix 5 (microfiche). It had been hoped to include details of the window glass in this report but unfortunately this has not proved possible. This material will be dealt with in a later volume of *CAR*.

### Public buildings

Few public buildings have been found on the sites discussed in this report and of those that were discovered none were of major importance in the Roman colony. The public buildings concerned are two temples (Buildings 52 & 53), the monumental arch at Balkerne Lane (pp 121-3), and a very small part of a building already known to have existed in *Insula* 29 (Building 27).

In addition, two important public buildings have been examined elsewhere. In 1981, at a site in Maidenburgh Street, Roman foundations were confirmed as belonging to the remains of a theatre and the outline of their plan was recovered (Fig 9). Details of this work are set out in Crummy 1982b. At the Culver Street site in *Insula* 35, a large basilica, 18m wide and at least 33m long, had been built along the street frontage on land previous occupied by private houses. Although of uncertain purpose, a church seems the most likely explanation for the building. Its method of construction was unusual in that it consisted of shallow foundations over large wooden piles (pp20-2). Details of the building will be given in the Culver Street report. (See also *Britannia*, 13 (1982), 371.)

The known public buildings of Colchester can be summarized as follows:

<i>Insula</i> 13	theatre
<i>Insula</i> 15	the so-called 'mithraeum' (p28)
<i>Insula</i> 18	wide foundations (Dunnett 1967, 39-40), little of plan known and purpose uncertain

<i>Insula 22</i>	Temple of Claudius
<i>Insula 29</i>	wide foundations (Hull 1960 and Building 27), little of plan known and purpose uncertain
<i>Insula 30</i>	very wide and deep foundations representing at least one major public building, probably a basilica (Dunnett 1971, 98-100; Crummy 1971)
<i>Insula 35</i>	large basilica, possibly Christian extra mural
Balkerne Lane	Temples 2-10 including the probable martyrium at Butt Road monumental arch

A full bibliography for all the temples of Colchester is given in Crummy 1980 where each building is described and discussed. This publication also includes the most recent plans of the possible martyrium and the 'mithraeum' although not the newly discovered ?Christian building in *Insula 35*.

## Private houses

Despite all the excavation which has taken place in Colchester over the years, no Roman house has yet been completely uncovered except possibly the houses examined by Wheeler in the Castle Park in 1920 (Wheeler 1921). In addition to the latter, the most completely excavated examples are Buildings 19 and 20 at Lion Walk and Building 70 at Middleborough. Where other large areas of buildings have been uncovered (*Insulae* 9A, 10, & 37), the information is insufficient to rationalize the resulting plans satisfactorily in terms of rooms and passages.

A striking fact which emerges when building plans are studied is how rare it is to find two foundations side by side. Many of the street frontages of the colony were heavily built up and there must have been many instances of buildings butting against one another. Paired foundations are uncommon because it was probably the normal practice for adjacent buildings to share a party-wall. This explains why it is sometimes difficult to decide how many buildings are present in a given complex of foundations and what the extent of each house was. This problem is well illustrated by Buildings 24 and 25. The remains uncovered by Wheeler in the Castle Park are sometimes described as a 'double courtyard-house' but if, as seems likely, some of the foundations supported party-walls, then the remains probably represent two or perhaps even three, separate houses. The clearest examples of party-walls occur in the fortress where barrack blocks built back to back shared a common central wall.

The earliest buildings were either reused military buildings or were strip-houses like Buildings 44-6 at Balkerne Lane. All the recently excavated courtyard-houses (Buildings 19, 20, & perhaps 70) appear to have been built around the middle of the 2nd century which is consistent with Mr Walthew's conclusion that this type of house did not appear in Britain until about this time (Walthew 1975, 192). On the other hand, Building 51 is unusual in that it dates to the

Neronian or early Flavian period and thus represents an exceptionally early example of a town-house of the single-corridor type (*ibid*, 189 & 191). The fact that Colchester was a colony may explain this anomaly. Another single-corridor house was Building 69 which appears to date from about 125.

Mr Walthew suggests that with the introduction into towns of the more complex house types, ie courtyard- and winged-corridor houses, there appeared much larger and better furnished houses than before (*ibid*, 204). This is certainly true of Colchester where from around the middle of the 2nd century, substantial town-houses were built which were much bigger than those they replaced and were as large as those found anywhere else in Britain. Also from about this time tessellated and mosaic pavements occurred commonly in houses throughout the colony. Curiously, the largest house (Building 70) known so far in Colchester lay outside the town walls; this extended about 42 m back from the street frontage.

## Ovens, hearths and kilns

During the course of the excavations described in this report, traces of over 60 small ovens and hearths were found. It is impossible to classify these remains very effectively since it is difficult to be sure what these structures were like in their original forms and what they were used for. The most obvious distinction between them is that some were surface-built and others were partly sunk below ground level. Most of the ovens are early which is probably indicative of a shift towards braziers with the widespread introduction of mortar and tessellated pavements.

Hearths were surface-built and usually survive as one or more tiles lying flat in a burnt patch on a floor. Most of the hearths found were set against walls (eg BKC JF93 in Building 44, MID F993 & MID F996 in Building 67, MID F744 in Building 69, & one in Building 3) whilst at least one had been placed towards the middle of a room (BKC VF96 in Building 46). There are two examples of a hearth made from a single tegula laid with the flanges upright (BKC JF93 & MID F993). Very little is known about the superstructures of these features. A well preserved hearth (BKC VF96) in Building 46 was open on one side only. Supported on the other three sides may have been a hood to carry the smoke to a vent which was placed in the roof or upper part of a nearby wall. Where these features consisted of a single tile or a neat group of four, they can be confidently described as hearths. However there are examples of irregularly shaped groups of burnt tiles which are more difficult to interpret. These may have been the remains of large hearths or the bottom courses either of an oven such as MID F951 (p 159) or a substantial surface-built structure like one found in the possible kitchen (LF238, Room 2, Phase 1) of Building 19.

Ovens for baking were set in oval key-hole shaped pits typically 0.3 m deep and 1.5 m long. Occasionally there was a piece of flat tile on the bottom of the pit (eg LWC LF183 in Building 19) but usually the sides were left as excavated. No wattles seem to have been used to build

the superstructure which probably was a small dome of daub. Only in one case did any of the superstructure survive (LWC LF183) and even here there was very little of it. No vitrified material was found in or around these structures and the low temperatures involved are consistent with the conclusion that they were used for domestic baking. About 20 of these ovens have been found at Lion Walk, Balkerne Lane and Middleborough; none were pre-Boudican. Perhaps the oven JF69 (Building 44), which was surface-built, represents the type in its pre-Flavian form?

At Lion Walk were found the remains of at least one forging hearth (p49). Also at Lion Walk there were two more furnaces, one apparently a bowl-shaped hearth (JF569; p36) and the other surface-built (p52). Both were used for bronze working.

A series of small ovens lay either inside or at the rear of Buildings 54-7 and 65 at Balkerne Lane (pp127-8 & 135). Each of these seems to have had a long flue with a comparatively small chamber at the end. The purpose of these is unclear. No waste matter was found which might suggest their function. Perhaps they represent a late form of baking oven.

Room 2 in Building 19 at Lion Walk appears to have been a kitchen and contained a series of interesting features (p54). This consisted of over six small baking ovens, a tile hearth, many stake holes and part of a rectangular structure built against the east wall (LF238). This last feature may have been a free-standing oven, a boiler, or a device with a hot-plate on the same principle as the modern range.

A Flavian-Trajanic pottery kiln was found at the Middleborough site. It lay alongside a street which later had three timber-lined wells nearby (pp182-4).

## Cemeteries

A general discussion of the town's cemeteries is planned for *CAR 4* which is to include the excavations at the cemetery sites of Butt Road (1977-9), Maldon Road (1971), and St John's Abbey Grounds (1972).

The remains of neonatal infants buried as inhumations were found in several places at Lion Walk and Balkerne Lane (Appendix 1, microfiche). Their presence is explicable by the custom whereby very young infants could be buried in areas of occupation (Wheeler 1936, 138-9). Two other burials were found at Balkerne Lane. Of these, the adult (AF47) lay in the bottom of the Period 6 town ditch and was probably an outlier of a cemetery to the west (p144). The other burial was of a child whose body (J187 in JF32) had been placed in a lead coffin and packed with plaster. The remains had been moved from the original place of burial and redeposited in a pit of Period 6 (pp143-5 & Appendix 2, microfiche).

## Water supply

In the vicinity of Colchester's town centre, at least nine springs are known all of which rise close to the

50 foot contour (Fig 14). This corresponds to the junction between the glacial sand and gravel and the underlying London Clay which, because of its impermeable nature, fixes the level of the water-table and thus the spring-line. The relationship of the fortress to the 50-foot contour is such that the military base must have been deliberately sited to lie close to convenient sources of water yet higher than the springs themselves (Fig 14). As a result, the fortress and most of the Roman town which replaced it lie up to 50 feet or so above the water-table and thus could only be supplied by water which was pumped or lifted up from the surrounding springs or was obtained by aqueduct from one or more sources at some miles distance.

Where the water-table is within a few metres of ground level, Roman timber wells occur; three were found on the low-lying site at Middleborough (p182) and others were discovered on the lowest parts of the Sheepen site (Hawkes & Hull 1947, 127). Elsewhere water seems to have been supplied through wooden water-mains as a pressurized supply. No conclusive example has yet been found of a Roman well within the town centre. Those wells which are known are usually about 50 feet deep (to reach the water-table), lined with stone and tile and of medieval or later date. Most medieval wells were probably shallow. Certainly, of the few examples known of this date, some of the more important ones lay at or very near the head of a spring and thus would not have been very deep, ie Childwell, Chiswell, Stanwell, and Stockwell (*Court Rolls* 1352, 1367, 1311, & 1367 resp). (An important exception is the large well which is in the Castle keep and is presumably of Norman date.)

Six separate Roman water-mains were found at Balkerne Lane where the evidence for Roman water-supply is an important feature of the site. Each water-main was made up of a series of straight wooden pipes held together by flat iron bands hammered into the thickness of the pipe walls to form a water-tight, pressure-resistant joint (pp115-7). Piped water seems to have been available at Balkerne Lane from the start of the colonial period until the beginning of Period 6 when the town ditch was extended across the main street (p117). Other wooden water-mains have been found at Middleborough (p179), North Hill (Dunnnett 1967, 31), and Long Wyre Street (Grew 1980, 378; *CAR 2*, 2913 & 2914). Fragments of a collar (*CAR 2*, 2867) were in an early medieval robber trench at Lion Walk but there were no traces of a main *in situ*. There is no evidence yet of a piped supply in the military period and probably all the water required by the army was collected at the springs and carried into the fortress. The supply at this time may have been augmented by a leat on the Sheepen site (Fig 14; Hawkes & Hull 1947, 34) which appears to have been for carrying water from the Sheepen Springs eastwards towards the fortress.

For many years, the Balkerne Lane area has played an important role in the supply of water partly because it was the highest place in the area of the town centre

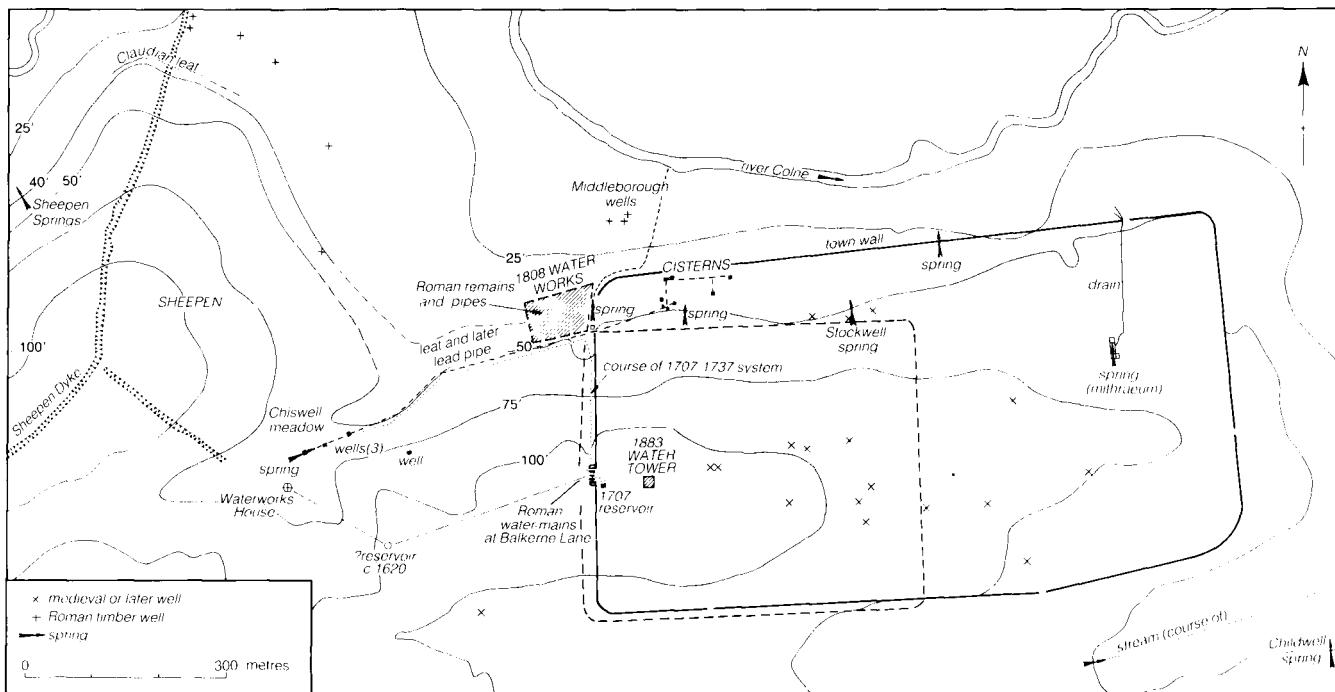


Fig 14 Colchester water supply. [Pages 26-8]

and partly because of the proximity of the springs at Chiswell Meadow and the foot of Balkerne Hill. Some information is available about the supply from the 16th century onwards and, in the context of what the Roman arrangements might have been like, these are worth a brief description. For the period up to 1737, the evidence for the following account is mainly contained in Morant 1748 (Bk 1, p2) and the plans cited below, all of which are in the Colchester Public Library (CPL).

At first water from the Chiswell spring was collected in a single reservoir in Chiswell Meadow and the course of the stream was diverted to run along a ditch or leat dug close to the 50 foot contour. The leat must have been in existence by 1536 and the reservoir by the late 16th century. The reservoir could have been a later improvement. The water-course reached the town wall close to the spring near the foot of Balkerne Hill. The latter was itself an important source of water and is shown on several of the principal maps of the town including the earliest (Fig 191, Speed). In 1536 and perhaps for many years before, the water from Chiswell spring was brought via the leat and perhaps some pipes into one or more cisterns or small reservoirs near North Street just inside the town wall. Thus by this means water was conveyed by gravity to the lowest part of the town. The system survived until at least the end of the 19th century. The layout of the pipes and cisterns in 1782 is shown in a drawing by William Cole (CPL 115) and the latest cisterns appear on the OS 1:500 survey of 1876. In his will of 1552, Ralph Finch made provision for the laying of lead pipes so that water could be conveyed along the leat without risk of pollution to the 'watering place at the Balkon' which was probably somewhere around the foot of Balkerne Hill.

The first system in which water was forced uphill seems to have been introduced in c 1620 (J H Round, *Essex County Standard*, 3 October 1883). Water was conveyed by gravity to upper parts of the town centre from a reservoir placed in the highest part of Windmill Field (which was next to Chiswell Meadow) and from there possibly straight towards the Balkerne Gate (Fig 14; A Phillips, pers com). The machinery was probably housed in 'Waterworks House' which stood in Chiswell Meadow.

In 1707 a reservoir was built on the south-east side of the Balkerne Gate. It was sited to lie within the highest area of the town. The reservoir was 24 feet square and at least ten feet deep with a capacity, later doubled, of about 6,300 gallons. Water was forced up from Chiswell Meadow in pipes which passed through one of the arches of the Balkerne Gate and into the reservoir. The course of the pipes between the meadow and the Balkerne Gate is not clear but they probably either followed the leat as far as the town wall and then turned southwards to rise up Balkerne Lane towards the gate or they followed the route of the by now defunct c 1620 system (Fig 14). The new arrangement could not be sustained. It was terminated in 1737 and Waterworks House and its adjacent buildings were demolished shortly afterwards. Two plans (CPL 48 & 52) exist which show Chiswell Meadow and the surrounding area about this time (in 1737 and 1758).

These arrangements were revived in 1808 with the construction near the foot of Balkerne Hill of new waterworks and two clay reservoirs. The water, still from Chiswell Meadow, was pumped by steam up the hill to a new, upper reservoir constructed more or less in the same place as that of 1707. To improve

pressure and capacity, a large water-tower ('Jumbo') was built in 1883 a little to the east of the upper reservoir by which time water was being obtained from boreholes.

The presence of Roman water-mains at Balkerne Lane implies the existence of a water-tower and the fact that several of these mains were contemporary indicates that this had been a *castellum divisorum*. A reservoir sunk below ground level would not have provided the head of water required to push the water out of the taps or valves at the ends of the mains since to do this the water-level in the reservoir would have had to be higher than the highest outlet. The mains at Balkerne Lane appeared to diminish in number as they passed westwards along the side of the main street giving the impression that the water tower was to the east of the town wall (pp 115-7). It is therefore possible that the Roman *castellum* stood close to the sites of the 18th-century and later reservoirs and the 1883 tower. Alternatively there could have been an arrangement which was reminiscent of the c 1620 system whereby a tower existed well to the west. This would explain the large number of mains in the area because then they could be seen as the means by which water was conveyed into the town. Such an explanation would mean that more pipes should have been found on the west side of the Balkerne Lane site than were detected although the practical difficulties of recognising the mains are such that this is possible. *Castella* are described by Vitruvius (*De Architectura*, viii.6) and good examples survive outside Britain, eg at Pompeii and Nîmes. In addition to providing a head of water, they were arranged internally in such a way that priority could be given to certain outlets in times of water shortage.

The sources of water for the Roman period are unknown. At Balkerne Lane the water might have been pumped up the hill or perhaps lifted in a series of water-wheels. The use of pumps has been suggested for similar circumstances at Lincoln (Thompson 1954) although there is some doubt about the efficiency of Roman pumps (Wacher 1974, 136-42). An alternative explanation is that water was brought to Colchester by means of at least one aqueduct. In this case, the source would have had to be substantially higher than the level of water in the tower which it fed so that the aqueduct could be built with a gradient of between 1:200 and 1:1000 (Singer *et al* 1956, 672). At Balkerne Lane there was a long timber structure which was traced over a distance of 43 m and may have been part of an aqueduct linking the town either with a distant source of water or a reservoir at the top of Windmill Field serviced by water-wheels or pumps. However it existed only for a relatively short time and as yet there is no evidence of an obvious forerunner or replacement for it (pp 119-21). The Lexden Springs yield much water and are only about 1.5 miles from the town centre. However they are too low-lying to have supplied an aqueduct. To find a source at a suitable height, the Roman engineers may have had to consider somewhere as distant as the upper part of the Roman River which is about seven miles from Colchester town centre.

Water could have been brought from here to the colony in an aqueduct with an average gradient of about 1:400.

The 'mithraeum' lay at the other end of the Roman town (Hull 1958, 107-13) and is remarkable for the spring which rose in the south end of its main compartment. Hull was convinced that the building was a mithraeum and in *Roman Colchester* dismisses the possibility that it could have been a waterworks (*ibid*, 111). Later, in 1954, Hull carried out some further excavations at the site and found an additional room which further reduced any resemblance the building had with a mithraeum (Crummy 1980a, 271-2). The spring is the highest and closest known to the town centre and in modern times would fill the main chamber to a depth of up to 18 inches. The slots in the floor of this chamber must have supported some gear for lifting water such as a water-wheel or a pump. The contours of the town are such that probably only a twenty-foot head would have been sufficient to provide the eastern half of the colony with pressurized water from this site.

## Footways

A feature of Roman Colchester which was unusual in Romano-British towns was the occurrence of footways along many of the streets. These were usually about 3.0 m (10 *pedes monetales*) wide and were separated from the adjacent street by a continuous foundation. They probably took the form of a verandah which in most cases crossed one side of an *insula*. An alternative interpretation is that the foundations between the footways and the streets supported colonnades. The floors of the footways are best illustrated by the example next to Building 20 at Lion Walk. Here there had been a succession of thin surfaces of very weathered small gravel with patches of abraded pottery and tile lying horizontally. The pattern of erosion was quite clear (p 62; Fig 42, Sheet 2b) and probably indicative of considerable foot traffic rather than exposure to the elements. Footways occurred at Middleborough, Balkerne Lane and *Insulae* 6, 28, 34, 35, 36, and 37. Buildings which do not appear to have had footways were in *Insula* 10. Dated examples (mainly Buildings 20, 54-7, 64-5, & 70) seem to suggest that they were not features of the early town but were later insertions. Where they do occur, footways seem to have been built on to the public thoroughfare so that the position of the frontage remained unchanged. This indicates that the land concerned was still in public ownership although there is evidence from Lion Walk (p 68) and Balkerne Lane (p 127) that the structures which covered these footways were built privately. The introduction of footways at Lion Walk is difficult to date and seems to have occurred in a piecemeal fashion.

## The stone architectural fragments

by Nina Crummy

The quantity and variety of the stone architectural fragments recovered from the Lion Walk, Balkerne

Lane and Middleborough sites has meant that the accurate identification of each piece and its likely provenance, often only possible by X-ray analysis or thin-section, would be prohibitively expensive since from these three sites there are over 200 pieces. In Appendix 3 (microfiche), the dimensions of each piece, the presence of edges or other features, and, where possible, common name identifications are given. The most significant moulded examples are illustrated. For many of the imported marble veneers there is only a colour description. As marbles can vary greatly in colour from one side of a large slab to another (eg Verde Antico), it is not always possible to be certain that the small pieces generally recovered in archaeological contexts belong to one of the more commonly-used varieties, as the particular distinguishing features may not be present.

Also in Appendix 3 the stone architectural fragments, mainly veneers, have been listed for each site by period. The pieces from the earliest contexts (Periods 1 and 2 at Lion Walk and Balkerne Lane) are veneers of Purbeck marble, Africano marble, Pavonazetto marble, an unidentified pinky-cream marble, and an unidentified greenstone. Purbeck marble is not a true marble, but a hard fresh-water gastropodic limestone quarried from beds in the Isle of Purbeck, Dorset which when polished is suitable for use as a decorative veneer. The recovery of a piece of Purbeck marble veneer in the fill of the fortress ditch at Balkerne Lane indicates that the exploitation of the Purbeck beds was begun early on in the Roman occupation of the province. The other veneer fragments from Periods 1 and 2 are imports.

Of the total number of architectural fragments just under half are of Purbeck marble or other stones from the Purbeck beds, and just under half are of imported marble or porphyry. Surprisingly, the variety of the latter group compares well with that of the decorative stones discovered in 1953 during an examination of part of the southern façade of the courtyard of the Temple of Claudius (Morris 1955, 48-9). Though some of the fragments from Balkerne Lane probably

derived from the extra-mural temples (Buildings 52 & 53), and possibly from the monumental arch nearby, the wide range of imported decorative veneers on Lion Walk and Middleborough seems to indicate that their use was by no means confined to public buildings (*see table*). On the other hand, when the scale of the Temple courtyard investigation is compared with the magnitude of the other excavations, it is clear that the veneers were much less common on domestic sites. There is thus the possibility that most if not all of the fragments of veneer from the latter category were reused (eg as in Building 20, Room 1) and derived from public buildings elsewhere in the town.

## Anglo-Saxon and Norman Colchester

*Colchester Archaeological Report 1* is devoted entirely to the subject of Colchester from the 5th to the 12th centuries. Readers are referred to this publication for information about finds, Anglo-Saxon huts, Norman stone houses, the replanning of the town and various other relevant archaeological and historical aspects.

## Medieval and later houses

Compared with their Roman counterparts, the number of medieval houses excavated in Colchester over the last decade or so is low. This is mainly because, with the exception of Middleborough, the major sites did not cover any part of the frontage of an important medieval street. The houses partly or wholly excavated were Buildings 28-33 at Lion Walk and Buildings 74-6 at Middleborough. In addition, parts of five other medieval houses have been examined during this period, none of which were well preserved. Two were at the Long Wyre Street site of 1978-9, two at the Cups Hotel site in the High Street excavated in 1973-4, and the fifth at 11 Magdalen Street, excavated in 1974. A detailed account of these buildings is planned for a later volume of the *Colchester Archaeological Reports*.

The work undertaken in this field so far has been of most value in two respects. First it has served to underline the fact that stone houses were common in early medieval Colchester. Including those excavated in recent years (Building 28 and one at the Cups Hotel site), at least seven early medieval stone houses are known to have existed (*CAR 1*, 53-67) and no doubt more await discovery. Second, not only were the floors of Building 76 unusually well preserved, but a substantial part of its superstructure survived which enabled the development of the building to be much better understood (pp207-8). Houses were often modernised in the 16th and 17th centuries by replacing their central hearths with brick chimneys and converting their open halls into two-storeyed blocks. Building 76 proved to illustrate this sequence very neatly.

Fragments of louvers (Appendix 4, pp211-14), a chimney coping (p202), and a stamped clay fireback (pp194-5) in association with houses at

	Temple of Claudius	Lion Walk, Balkerne Lane, and Middleborough sites
Africano marble	16 fragments	7 fragments
Rosso Antico marble	12 fragments	none
Verde Antico marble	none	3 fragments
Pavonazetto marble	9 fragments	6 fragments
Giallo Antico marble	1 fragment	none
Cipollino marble	'some small chips'	11 fragments
Carrara marble	2 fragments	3 fragments
Unidentified marbles	2 marbles	58 fragments of about 15 marbles
Greek green porphyry	1 chip	7 fragments
Imperial (red) porphyry	none	4 fragments

Table

Middleborough and Culver Street suggest that medieval chimneys of wattle and daub must have been common in Colchester. None of the louvers were of the type associated with the archetypal open hall with its central hearth open to the roof but were all intended to fit into the top of a chimney. The hearths, both central and wall, presumably had some kind of hood suspended overhead from which rose a chimney. The absence of smoke-blackened timbers in the hall side of the Phase 3 cross-wing of Building 76 reinforces this conclusion.

A good example of a medieval house built before the 14th century is yet to be excavated in Colchester apart from the two stone houses already mentioned. In the grounds of St John's Abbey, lumps of burnt 'daub' have been recorded which had derived from buildings destroyed in a fire of 1133 (*CAR 1*, 41-2). Some of the fragments seemed to be large as if the walls of the buildings had been of solid daub. The typical house of the 15th and 16th centuries was timber-framed with ground-plates set on low plinths of mortared tile. Frequently floors were made by laying down a thick layer of sandy daub (eg Building 28, Phase 2). Timber floors at ground level first occur in the 18th century (Buildings 28, Phase 3 & Building 76, Phase 6).

### **Defences of the post-Roman town**

In the 11th century, a deep ditch was dug at the foot of the town wall for part of its circuit (p84; *CAR 1*, 52-3) and c 1400 the wall was extensively refaced when a series of bastions was added (*CAR 1*, 52-3). One of the bastions was found at Lion Walk where it was shown to be contemporary with the adjacent refacing of the wall (p84). Balkerne Gate and Duncan's Gate were no longer in use but new gates were made at Rye Gate, Scheragate and by St Mary's Church (Hull

1958, 34-62). The last of these was partly excavated in 1972 and found to be not a properly-built gate but a Roman drain which had been enlarged so that people could pass through it.

### **Lime production**

Lime was made by roasting oyster shells (calcium carbonate) in kilns to produce calcium oxide (quick lime). Shells and charcoal were placed in the centres of the kilns and, after roasting, the lime was raked out into pits at the sides. The use of shells at Colchester is unusual since chalk was normal (Singer *et al* 1956, 355). In the early medieval period the lime burning was done in a kiln which took the form of a large, circular pit four to five metres across from which the lime was removed via one or more tunnels. Four kilns of the large type were found at Lion Walk (pp86-7) and a fifth was discovered at St John's Abbey grounds in 1973 (*CAR 1*; 41 & fig 36). Within a few centuries or so, a more efficient design of kiln was employed which was much smaller. Each of these consisted of a central chamber flanked by two raking-out pits. At the south end of Lion Walk, on Site L, there was a complex of at least nine of the smaller lime kilns in which five phases were detected (pp87-91). Unlike the earlier type, parts of these kilns were vitrified. Thus they seemed to have reached higher temperatures and therefore they probably converted the shells more quickly. Characteristically, the sides and bases of the kilns were lined with thin, often hard, layers of white, powdered or crushed oyster shell. The two types of kiln are closely matched in date and design by the two medieval lime kilns found at Portchester Castle (Cunliffe 1977b, 56-60) except that at the latter the pit of the early example was square rather than round.

## Fortress

[General plan Fig 4, p4]

At Lion Walk the principal military remains consisted of parts of the eastern defences of the fortress, the southern defences of the annexe, seven buildings, and four streets including the *via sagularis* (see below). Before any of these were built, the topsoil had been removed over the whole site except for a few places where some prehistoric flints and pottery were found (to be published later). No features were discovered under the ramparts, the streets or the walls of the buildings. Over most of the site (Sites C, J, K, & L), there was a scatter of early pits. These seem mainly to have been contemporary with the Period 1 buildings although some may have been caused by the uprooting of trees and bushes prior to the building of the fortress.

## Military defences

[LWC Sites B & A/R; general plan Fig 15, p32; detail plan Fig 16, Sheet 1a: large-scale plan Fig 18, p33; photograph Fig 19, p34, Sections 56-8 & 61, Sheet 6a]

The fortress ditch and the *via sagularis* were traced for a distance of 53 m from Site B, where they were found by excavation, to the northern edge of the contractor's basement excavation where the defences and the street were visible in section (Sx 61). The rampart was 3.8 m wide and consisted of a bank of sand revetted by two walls of coursed, unfired blocks or slabs of sandy clay loam overlying an oak corduroy. A layer of sandy clay loam laid to the front of the rampart continued into the ditch and may have been intended as a lining. The ditch varied slightly in its width and profile because of the soft nature of the sand which forms the subsoil.

During the contractor's excavations, the ditch of the annexe was traced for a distance of 40 m and found to stop 9 m short of the north-south ditch of the fortress. The rampart (excavated on Site A/R) was identical to the north-south rampart except that being 4.1 m across it was slightly wider (Figs 18 & 19). Traces of a strip of decayed wood lay at the foot of the southern edge of the rampart for 5.9 m of its length. This may have been the end of the corduroy projecting beyond the face of the rampart or, less likely, the ground-plate of a timber front. The blocks which formed the revetment were 100 to 120 mm thick, 180 to 250 mm wide, and of variable length. (The relationship of the slabs to the sand bank is shown in Sxs 56-8.) The ditch was sectioned completely in one place only (Site A/R) where it was found to be 2.5 m deep and 5.0 to 5.7 m wide (Sxs 56-8). Unlike the north-south defences, there was no contemporary street behind

the rampart. The first street in this position was civilian (see below) and sealed a succession of deposits which contained slag and pieces of furnace lining from one or more iron-working hearths. An oven (Fig 18; RF88) was built into the back of the rampart. The absence of slag or furnace lining in its immediate vicinity suggests that it was not associated with the metal-working but that it had been used for baking. Three postholes, two (AF122) south of the rampart and one (RF77) north of it, may have been parts of a structure associated with the oven.

## Buildings 1-6 (Period 1)

[LWC Sites M, L, C, Q, K, & P; general plan Fig 15, p32; detail plan Fig 17, Sheet 1b]

Only small parts of Buildings 1-6 could be excavated (Figs 15 & 17). However they are readily identifiable as having been military since they were laid out in the fashion characteristic of legionary barracks. The six buildings were set out as three pairs (Buildings 1 & 2, 3 & 4, 5, & 6) so that each pair was divided by a narrow street and Buildings 2 and 3 and Buildings 4 and 5 were back to back. The eastern ends of the buildings formed distinct blocks about 18 m long. These are recognizable as detached centurions' quarters because of their plan, their relationship to the defences, and the higher quality of their construction. The external walls of these blocks and the single walls which formed the spines between Buildings 2 and 3 and Buildings 4 and 5 were supported by plinths made of stone and mortar. The plinth common to Buildings 4 and 5 was traced westwards for a few metres beyond the end of the centurion's quarters indicating that all of the spine wall in this and other barracks may have been built on a plinth.

The material used to construct the superstructure of the principal walls was the same as the sandy daub used to build the revetments of the ramparts and was laid in the form of sun-dried blocks. These were placed over timber ground-plates which rested along the tops of the mortared plinths. The technique is described elsewhere (p22, Fig 11).

The internal walls were narrow, being 0.25 to 0.40 m in width, and were of two types. Most had timber ground-plates laid directly on to the ground whilst there were some which consisted of posts set in a shallow slot. In both types the infill between the upright timbers was either wattle and daub or blocks of sandy clay similar to those on top of the plinths but of smaller size. Both types of internal wall existed by 60/1 (see below) although it is not certain that the wattle-and-daub type occurred in the military period.

The internal layout of each of the eastern blocks is hinted at in Buildings 3 and 5 where they appear to



FIG 16

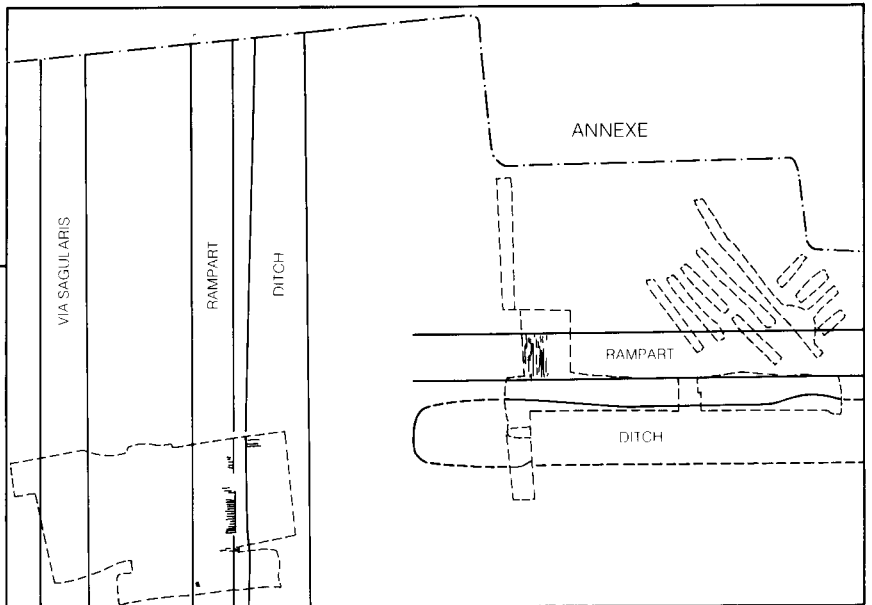


FIG 17

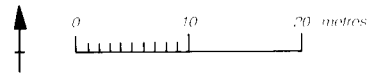
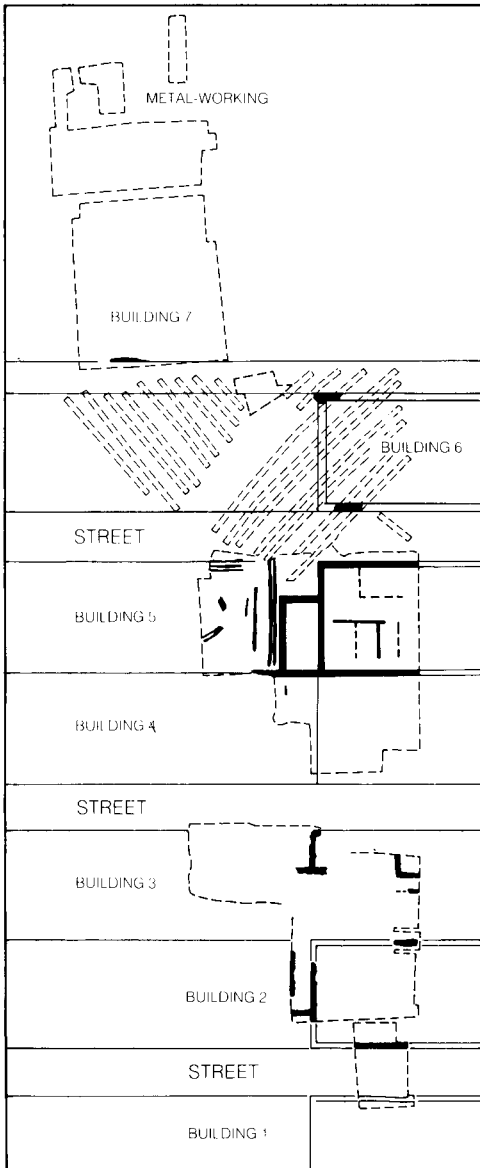


Fig 15 Lion Walk Period 1: general plan. [Pages 31-7]

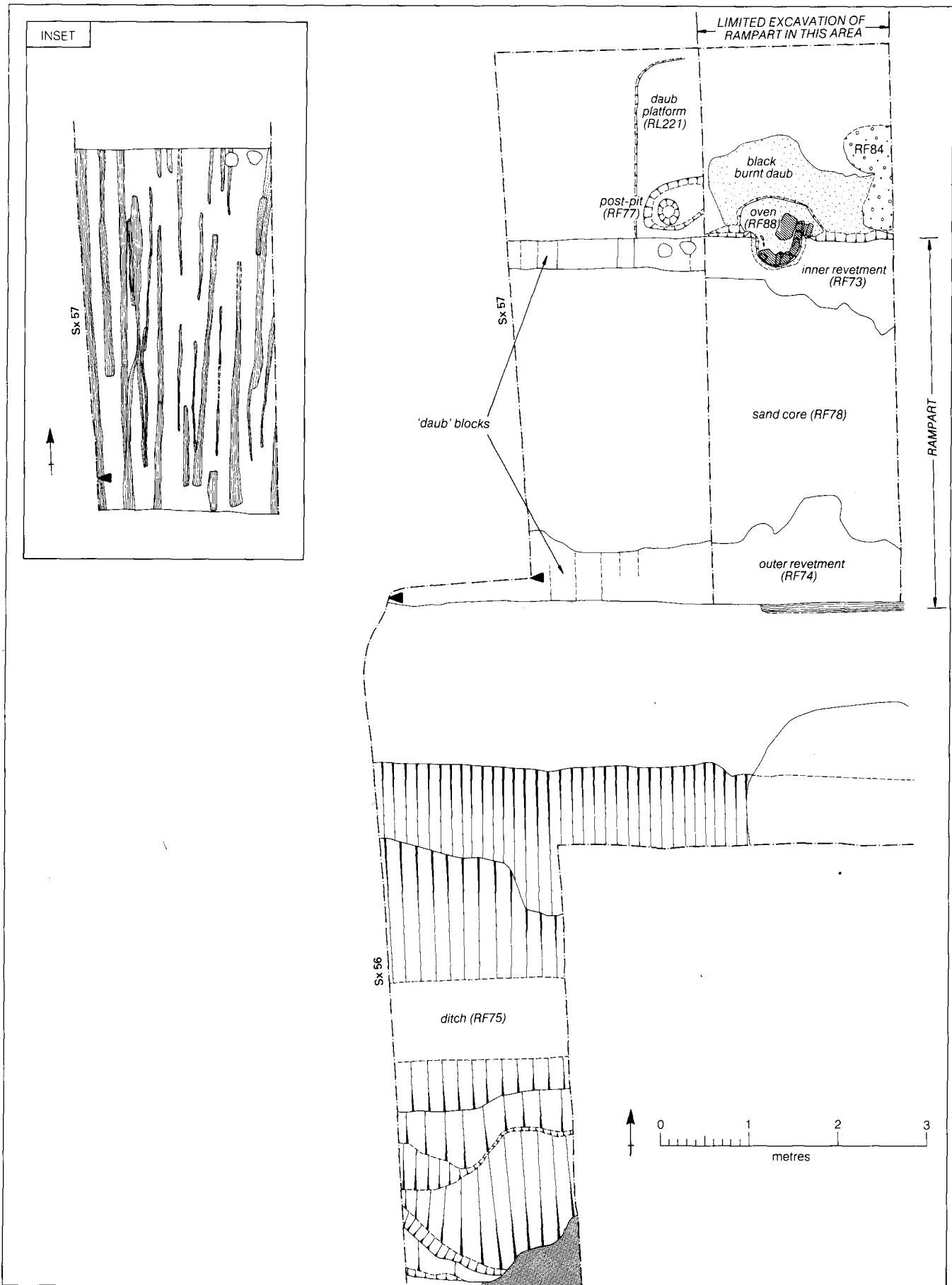


Fig 18 The annexe defences with oven in rear of rampart. Inset shows timber corduroy. 1:60. [Page 31]

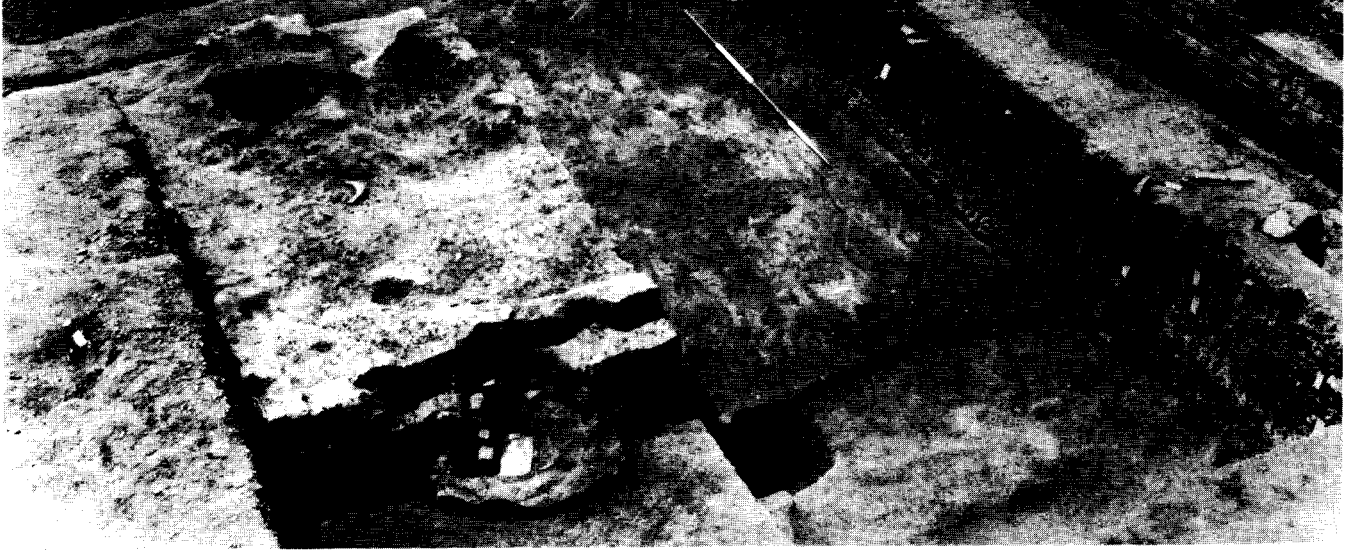


Fig 19 The defences of the annexe at Lion Walk viewed from the north. [Page 31]

have had central passages flanked by rooms. This kind of arrangement is characteristic of centurions' quarters elsewhere (eg Caerleon and Chester; Webster 1969, 194, fig 40). Unfortunately, a large enough area of the remaining parts of the barracks could not be excavated so details about the internal divisions of the *contubernia* could not be recovered. No satisfactory explanation can be offered for the curved slots in Building 5 but the apparent military character of Buildings 1 to 7 can hardly be dismissed on the strength of these slots in view of the weight of evidence favouring a military attribution. The remains of each building can be summarised as follows.

### Building 1 (Period 1)

[LWC Sites L & M; general plan Fig 15, p32; detail plan Fig 17, Sheet 1b; large-scale plan Fig 22, p38]

Only part of the north wall was uncovered. This had been robbed in the early post-Boudican period, the robber trench being LF285 (Fig 22).

### Building 2 (Period 1)

[LWC Sites C & L; general plan Fig 15, p32; detail plan Fig 17, Sheet 1b]

Substantial parts of the plinths of this building survived. Inside were some pits (CF215, CF235, & CF239), an internal wall (CF214), and some postholes.

The relationships of the pits to the building were not clear; some may have predated the building whilst others may have been contemporary or later than it. Pit CF235 contained an almost complete gridiron (CAR 2, 2052) lying face downwards which may have been used in the building. A line of north-south postholes set in a shallow trench (CF212; Sx12, microfiche) was found. This is the only place at Lion Walk where a line of early postholes can be interpreted as having clearly formed a wall in a recognizably military fashion apart from perhaps in Building 5. A shallow strip of sandy clay (CF214) was only a few centimetres deep and was formed of the same type of material used in the trench with the postholes. This was probably an internal wall in which the timber-framing has decayed without trace (assuming it existed). These postholes were similar to some others (CF226-9) which lay along the southern side of the northern plinth of the building. The positions of all these postholes are clearly secondary to the plinths so that the posts must represent either original internal partitions or later modifications to the building. Other postholes must have existed but evidence for these was not recovered.

### Building 3 (Period 1)

[LWC Sites C & Q; general plan Fig 15, p32; detail plan Fig 17, Sheet 1b]

Inside Building 3 were the remains of three daub

walls (CF217, CF220, & CF221; Sxs 18 & 19, microfiche) similar to CF214 in Building 2. On the north side lay a small hearth in the form of a tegula. There were several pits (CF200, CF201, & CF234) and two postholes (CF205 & CF206). The latter probably formed a continuation of the wall CF212 in Building 2. Large areas of Building 3 had been destroyed in post-Roman times when many pits and trenches were dug on the site.

### Building 4 (Period 1)

[LWC Site K; general plan Fig 15, p32; detail plan Fig 17, Sheet 1b]

The plinths of Building 4 had been robbed and the Period 1 floor levels were not examined during the excavation. The northern plinth was removed in the Neronian or Flavian period and the north-south plinth, which lay in the south-west corner of Site K, was dug up in early medieval times. The latter occurred during the robbing of a more substantial later Roman foundation which overlay the plinth.

### Building 5 (Period 1)

[LWC Site K; general plan Fig 15, p32; detail plan Fig 17, Sheet 1b; photograph Fig 20, p35]

Of the six barracks examined, Building 5 proved the most fruitful. Most of its plinths had been robbed out in the early post-Boudican period so that only scatters of stones were left at the bottoms of the robber trenches. The positions of the plinths are indicated by the trenches KF202, KF236, KF237, KF249, KF309, and KF294. Features KF200 and KF311 were undisturbed sections of plinth. Traces of early floors were slight and it appears that initially the natural sand was used, perhaps with a covering of rushes (although there is no evidence for this other than the fact that floors of sand would have been very soft). Internal partitions were provided by narrow walls of sandy daub (KF369 & KF370), perhaps strengthened by stakes (KF322 & KF362). The floor KL611 was of the same material as the wall KF369 so that either it was laid down as a floor when KF369 was built or it resulted from the latter's demolition. In either event, the eastern edge of KL611 may indicate the position of another wall, traces of which have otherwise been removed. If this was the case, then it must have delineated a corridor or a narrow room. The positions of the other rooms may be indicated by KF318, KF319, KF348, KF349, K350, KF361, KF363, and K364.

The locations of the walls of the western part of Building 5 were indicated by a number of shallow slots, 0.15 to 0.25 m deep, in which were shallow depressions (Fig 20). The original ground surface had not been lowered to any extent, so that the slots were not the bottoms of the type of deep construction trench characteristic of military sites. The most plausible interpretation of these features is that they correspond to the bottoms of walls and that the shallow depressions resulted from the removal of the uprights in the walls during their demolition. The occurrence of two or more slots side by side probably



Fig 20 Slots KF354-6 in Building 5. [Page 35]

points to some rebuilding. A curious feature in an anomalous position was a pair of curved slots (KF334 & KF335) which was continued northwards as KF336. There is no reason to doubt that these were broadly contemporary with the rest of the building.

### Building 6 (Period 1)

[LWC Site P; general plan Fig 15, p32; detail plan Fig 17, Sheet 1b]

Building 6 lay in a part of the site which of necessity could only be trenched by machine. From what could be seen in the sides of the trenches, the plinths seemed to have occurred only in the area of the eastern block.

### Building 7 (Period 1)

[LWC Site J; general plan Fig 15, p32; detail plan Fig 17, Sheet 1b; interpretative plan Fig 21, p36; flow diagram Fig 31, p43]

Interpretation of the various features and layers associated with Building 7 is difficult partly because unlike Buildings 1 to 6, the military structures were replaced by new buildings in the civilian period. For the same reason, the plan of Building 7 is also difficult to discern. However, the principal elements of Period 1 on Site J consist of pits, gullies and a substantial quantity of dumped sand and sandy clay around the middle of the site with, to the south, an east-west plinth (JF385) and to the north, under the Period 2 street, evidence of metal-working.

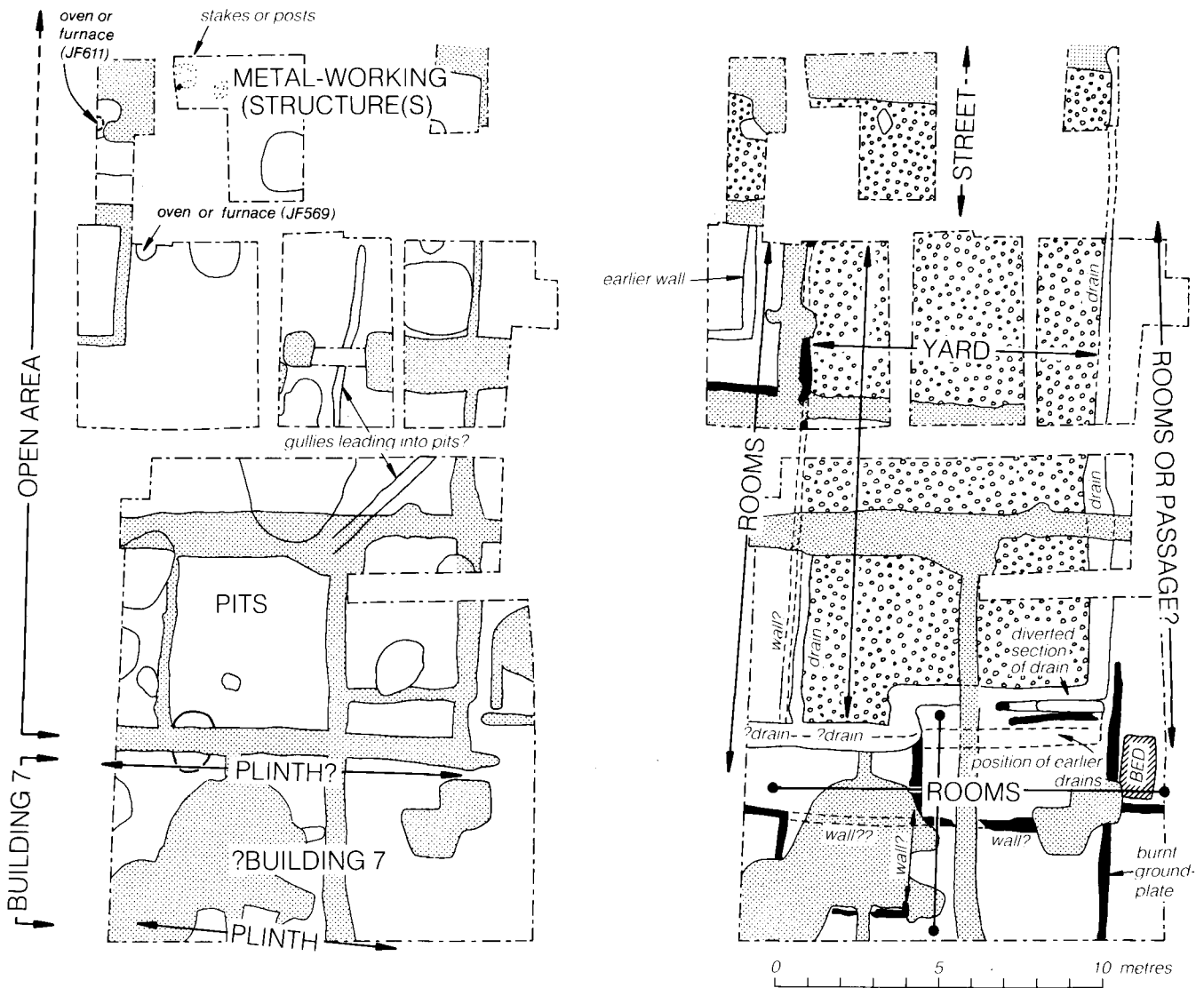


Fig 21 Interpretation of Building 7 (left AD 44-9) and Building 8 (right AD 60/1). [Pages 35 & 40-1]

The plinth JF385 shared the military alignment and was of the same type of structure as those in Buildings 1 to 6. It represents the south wall of Building 7 and was the only wall of this period to be found on Site J (Figs 17 & 21). The dumped material in the middle of the site petered out more or less along the line of the Period 2 drains (JF423 & JF424) suggesting that the position of these coincided with the northern limit of Building 7. If correct, this indicates that the building was only about 6 m wide (at least in this area) and that stake holes, found mainly in the southern half of it, were the only internal features located within the building (Fig 17).

Some of the pits and gullies had clearly lain open for some time. In one instance, a gulley led into the pit JF419 and had the appearance of having been formed by storm water as if the area had been open and neglected. The relationships between the pits and Building 7 are obscure especially since all the pits need not have been contemporary. During the excavation it had been thought that the pits were probably the result of uprooting trees and shrubs during the initial site clearance undertaken as part of

the preparatory work for the building of the fortress. Without doubt, the pits are stratigraphically early (Sxs 33, 35, 37, & 40, microfiche) but the occurrence of occupation material in many of them suggests that they were mainly contemporary with Building 7. Moreover at least one pit (JF405) was dug early in Period 2 when major building works were in progress (*see below*) and thus the same may be true of some of the others. Much of the dumped material in the middle of the site probably derived from the digging of some of the pits.

The metal-working area under the street consisted of several very heavily burnt patches of daub associated with much occupation debris which included fragments of charcoal and 'drips' of copper alloy. Two ovens or furnaces (JF569 & JF611) were also found in this area as well as the bottoms of two stakes or small posts. Quite remarkably, the stumps of these stakes still survived as mineralized wood. They projected upwards by a few centimetres into the gravel of the Period 2 street and thus showed that the structures to which the stakes had belonged had been demolished immediately before the street was laid.

## Streets (Period 1)

[LWC Sites B, L, Q, & K; general plan Fig 15, p32; detail plan Fig 17, Sheet 1b; large-scale plan Fig 22, p38; Section 61, Sheet 6a]

Parts of three east-west military streets were examined, ie those between Buildings 1 and 2 (Site L), Buildings 3 and 4 (Site Q), and Buildings 5 and 6 (Site K). In addition, the *via sagularis* was excavated on Site B and observed in the north section of the contractor's excavation for the new basement (Sx 61, Sheet 6a). In every case, the packed gravel and sand which formed the metalling appeared to be of one period and was at most 0.25 m thick. The *via sagularis* was 4.4 m wide and seemed to be neatly cambered (Sx 61, Sheet 6a). The street between Buildings 1 and 2 contained several gullies or slots (Fig 22; LF237, LF242, LF282, & LF287) which may have been wheel ruts. The gap between Buildings 6 and 7 was about 2 m which was too narrow for a street.

## First civilian occupation (AD 49 to 60/1; Period 2)

[LWC general plan Fig 23, p39; detail plans Figs 24, Sheet 1a & Fig 25, Sheet 1b]

This was a period of substantial change. The military defences were levelled and two new streets at a right angle to each other were set out on a slightly different alignment to the military remains. One street was laid out over the backfilled north-south ditch (Sx 2, microfiche & Sx 61, Sheet 6a) and the another was placed so that on Site A/R the new street was several metres to the north of the demolished rampart of the annexe. Buildings 3 to 6 were kept at least in part for re-occupation in the new colony although substantial alterations took place within several of them. The military streets between Buildings 3 and 4 and Buildings 5 and 6 were probably also retained whilst Buildings 1, 2, and 7 as well as the presumed *contubernia* of Building 5 were all demolished, and their vacant sites (including the street between Buildings 1 and 2) used for cultivation if not by 60 then shortly afterwards. Timber-framed buildings (Buildings 8-10) without mortared plinths were erected along the frontages of the new streets and the land between the levelled north-south ditch and the eastern ends of the centurions' quarters was built over so that the *via sagularis* and the remains of the north-south rampart were sealed by the floors of the new houses (Sx 9, microfiche & Sx 61, Sheet 6a). The new east-west street overlay the site of the earlier metal-working area within the fortress (ie north of Building 7, Site J) and also sealed some deposits containing metal-working debris inside the annexe (Site A/R; Sxs 56-8, Sheet 6a).

An extensive sequence of structural changes was found on Site J in the vicinity of Building 7 and the metal-working area to the north. Despite being difficult to interpret, the sequence is important for two reasons. Firstly it points to two clear periods of pre-Boudican buildings reconcilable with the fortress and the colony respectively. Secondly the number and sequential nature of the modifications which took place during the second period are such that a span of

many years must be implied for these activities and that therefore identification of the first period of building with the fortress mentioned by Tacitus is the more plausible.

Building 8 contained the only mortared plinth to be found which was not built during the military period. Although of similar construction to the others, it differed in two ways. The mortar was whiter and less yellow than that normally used and, most significant, the plinth contained small fragments of broken tile, a fact consistent with its secondary context and explicable by it.

In 60/1, all the buildings were destroyed by fire and the floors covered by lumps of crushed, burnt daub and charcoal. The degree of preservation of these remains varied across the site and depended to a large extent on the thoroughness of the preparatory work for the rebuilding operations of the immediate post-Boudican period where the aim seems to have been to clear away the debris so that the new ground level was as close as possible to the level before the fire. The best preserved area was on Site J where in the centre of the eastern side the debris was 0.35 m thick and the base of one of the stud-and-wattle walls (JF312) was *in situ* to a height of 0.50 m (Sx 41, microfiche).

## Buildings 3-6 (Period 2)

[LWC Sites C, K, P, & Q; general plan Fig 23, p39; detail plan Fig 25, Sheet 1b]

The centurion's quarters of Building 3 were destroyed by fire 60/1 and thus must have survived the transition from fortress to town. The internal arrangements, where these could be detected, seemed to have been of one phase so that the centurion's quarters appear to have been reused in the colony without modification.

Substantial alterations took place within Building 4. New floors were laid which were made from the debris left after the demolition of internal walls. This was especially clear in Section 49 (microfiche) where the floor of Period 2 could be seen to contain large lumps of daub wall and fragments of wall plaster. The latter implies that the military buildings were plastered at least in part or that the plaster was secondary, perhaps added in the civilian phase. Three new partitions were laid out east-west (KF148, KF170, & KF174). These incorporated timber ground-plates which survived as charcoal in the bottoms of slots. In the south-east corner were some stake holes and some small pits. No parts of the *contubernia* of Buildings 3 or 4 were examined so that it is not known whether these were kept for civilian reuse.

In Building 5, the original east-west wall along the centre of the block was replaced by another in roughly the same position (Sx 46, microfiche). The western end of the new wall incorporated a post set in a large pit (KF317), which must have cut the north-south plinth to the west (later robbed leaving the trench KF237). In the same wall but 3.2 m to the east was another post (KF323) also set in a pit (KF324). On the

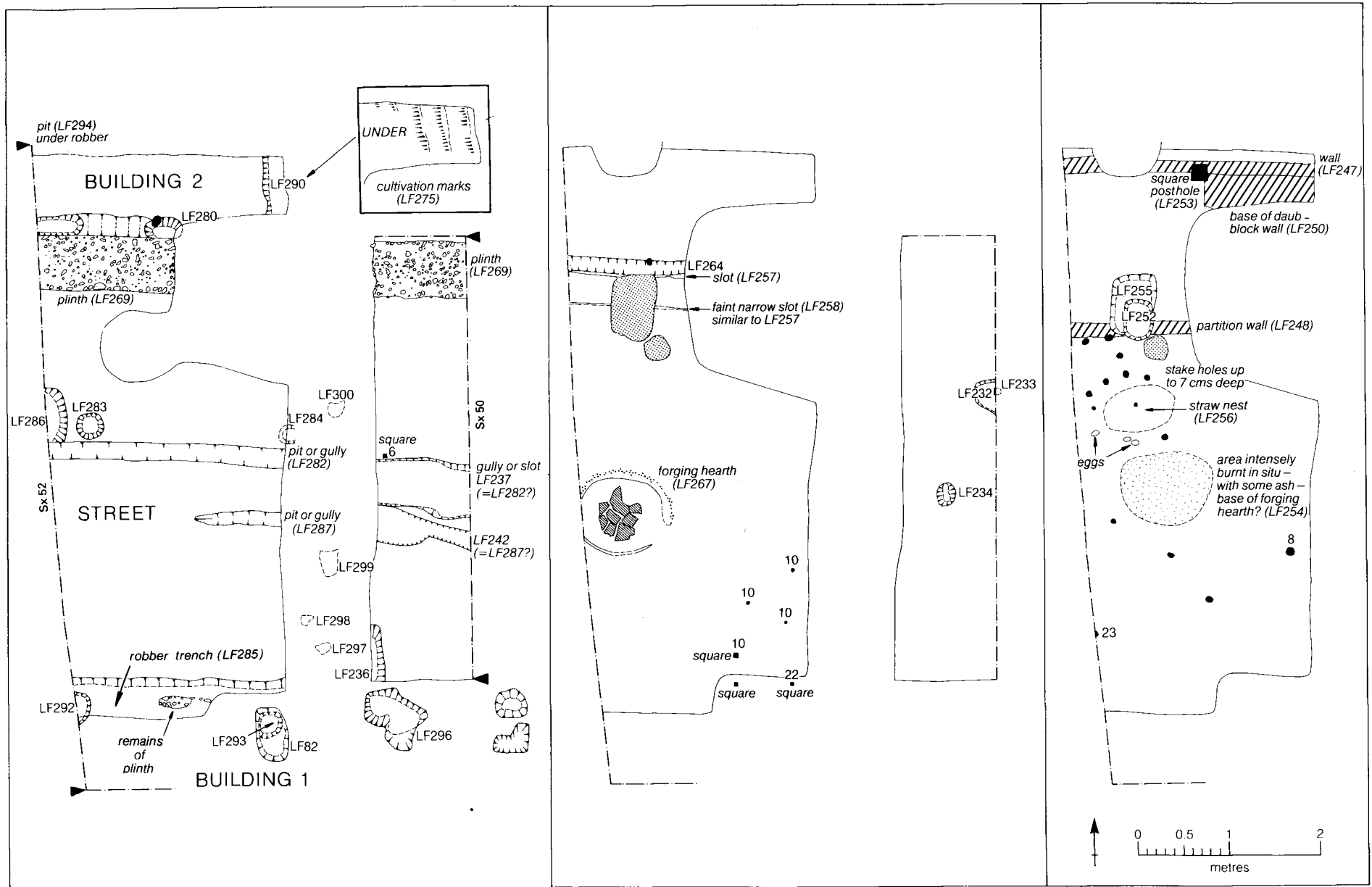


Fig 22 Site L: the street between Buildings 1 and 2, and cultivation marks of Period 2 (left), Building 11 (centre), and Building 12 (right), 1:60. [Pages 37 & 49-50]

FIG 24

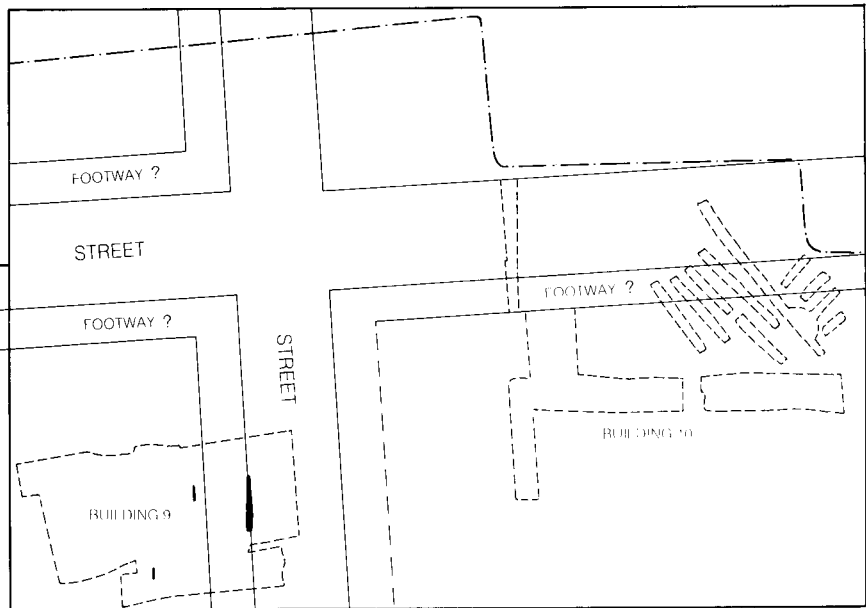


FIG 25

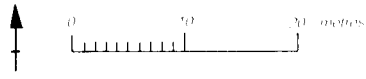
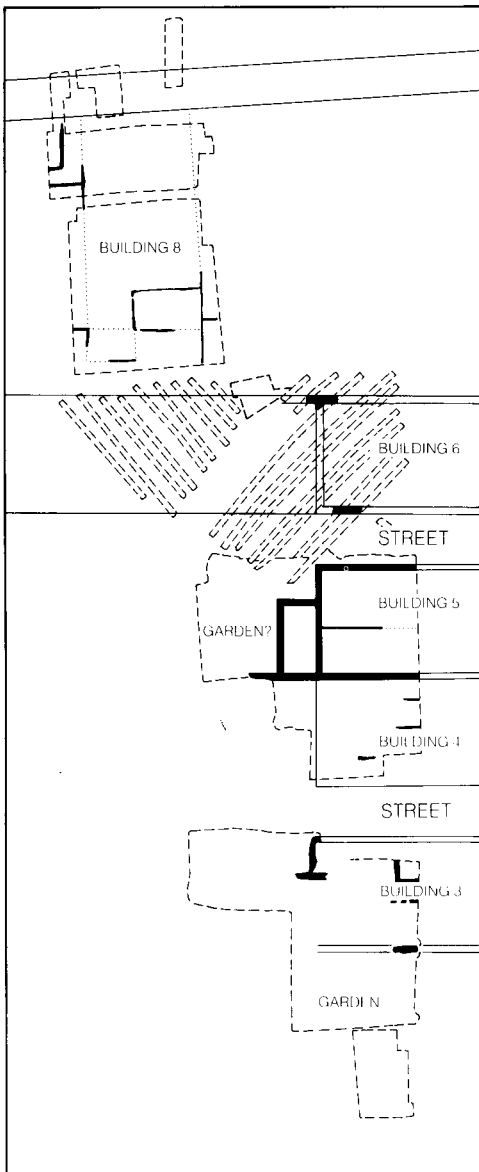


Fig 23 Lion Walk Period 2: general plan. [Pages 37-49]



floor just inside the north wall lay a group of burnt dates and a plum (see below; KF227; Fig 26). The *contubernia* had been demolished before the fire. A premature baby had been buried in a small pit (KF367) at the north side of the building (Appendix 1, microfiche). Stratigraphically it was not possible to be certain if the burial belonged to Periods 1 or 2. In view of circumstances, a military context seems most unlikely so that Period 2 is clearly preferable. The pit was placed close to the end of the Period 1 slot KF328 as if the wall in this position had been extant at the time. If correct, then this would suggest that the structure to the west of the centurion's quarters survived into at least the start of Period 2.

Little can be said about Building 6 except that from the sections of the machine-cut trenches, the extent of the Boudican burning clearly indicated that the centurion's quarters and as much of the *contubernia* as was available for trenching were burnt in 60/1.

### Carbonised fruits from Building 5

by P Murphy

[Fig 26, p40]

Large carbonised dates and a plum (Samples 3725, 3726, & 3767) were collected by hand from a single deposit (Fig 26) during excavation.

Sample 3726 comprises a single fragmentary fruit of *Prunus* sp. The fruitstone is obscured by a cokey mass representing the remains of the mesocarp, but is fractured across its centre, where it is 10.5 mm broad by 7.2 mm thick. This is a large stone (though some expansion may have occurred during carbonisation) and is probably of a plum (*Prunus domestica* subsp *domestica*). Fruitstones of plum are common at Roman sites in this country, though this specimen does provide an early record of the crop.



Fig 26 The burnt dates and plum. [Page 40]

Samples 3725 and 3767 are of fruits of the date (*Phoenix dactylifera*). Sample 3725 includes twenty-two fruits, 3767 a single specimen. The fruits are all separate, showing no signs of having been pressed into blocks for transportation. Dimensions of fruits and of the furrowed elongate fruitstones exposed in fractured specimens are in the table below.

Sample no	Length (mm)	Breadth (mm)	Thickness (mm)	Number measurable
3725 (fruits)	46-56	24-29	12.5-23.0	17
3725 (fruitstones)	26-28	7-8	5-6	5
3767 (fruits)	-	23	26	1

Table

These specimens provide, at present, the only record of this crop from Roman Britain. Their source is unknown, but clearly they were imported from the Mediterranean area. ■

### Building 8 (Period 2)

[LWC Site J: general plan Fig 23, p39; detail plan Fig 25, Sheet 1b; large-scale plan Fig 29, Sheet 2a; interpretative plan Fig 21, p36; flow diagram Fig 31, p43; photograph of drains Fig 30, p42; wall JF312: plan of wall Fig 11, p21; wall plaster Fig 28, p41; photograph of wall Fig 27, p41]

Building 8 was erected on the south side of the new east-west street. Little is known about its plan except that the building was set out around three sides of a gravelled yard, the north end of which was contiguous with the street. Almost all the walls were timber-framed with plates laid on the ground. Most of them were of the stud-and-wattle type, the best preserved example being JF312 (Figs 11, 27, & 28). Three walls seem to have been built of daub blocks (JF420, Figs 12 & 29; JF406 & JF399, Fig 29). The fact that these were in the western half of the site (Site J) suggests that Building 8 may have been at least two separate buildings, one with walls of wattle and daub and the other with walls of daub blocks. A third type of wall was represented by the mortared plinth JF308. Several of the walls including the plinth had wall plaster surviving *in situ* (JF406, JF399, JF316, JF312, & JF308). In the Boudican debris were large quantities of keyed daub (pp23-4; Fig 13) and many fragments of roof tile (Appendix 5, microfiche), the latter indicating that the roof had been tiled. Neatly placed in the corner of a room on the east side of the site were the burnt remains of a bed (see below).

Around the east, west and south sides of the yard was a system of timber drains (Figs 29 & 30). Along the eastern drain and the eastern half of the south drain were the extensive remains of burnt oak planks. These show that this part of the system must have been open to the air and not buried because otherwise the planks would not have been burnt. For most of its length, a small vertical slot was found along both sides of the bottom of the east drain (Sx 39,



Fig 27 The burnt daub wall JF312. [Pages 21 & 40]

microfiche). These were made by the lower edges of planks which had formed the sides of the drain. Wedged or lodged between these had been a series of single planks probably butted end to end to form the bottom of the drain. In the sides of all the drains were some iron nails which were horizontal and placed on average 0.1 to 0.2 m above the bottoms of the drains. These had originally been driven into the sides so that where the nails were longer than the timbers they pierced, their ends projected into the sand behind. Many of these nails were held in their original positions by the soft sand despite the wood either having been burnt or left to decay. It is not clear if the drain had a cover. The nails may have held a system of horizontal battens arranged not only to hold the planks together and keep the side members vertical but also to provide a support for a plank cover.

The system drained from the north end of the west drain (26.17 m above OS datum) to the north end of the east drain (25.65m OS datum). This gives an average gradient of about 1:60 although, because there appears to have been a step at the bottom of the west drain, the actual gradients of the drains were much less.

Building 8 and its drainage system were much altered. The south drain (JF423) was replaced (JF424) and this in turn was later diverted at its east end (JF315b) when a new wall (JF308) was built. The floors of Building 8 sealed the remains of the plinth of Building 7 (Sx 31, microfiche) and were probably derived from the debris generated by the demolition of this building (Sx 40, microfiche). The original south drain (JF423) also post-dated the demolition work since it sealed a pit (JF405, Fig 17) which contained small fragments of broken plinths. The sequence of principal alterations to Building 8 and its drainage system is summarised in Figures 21 & 31.

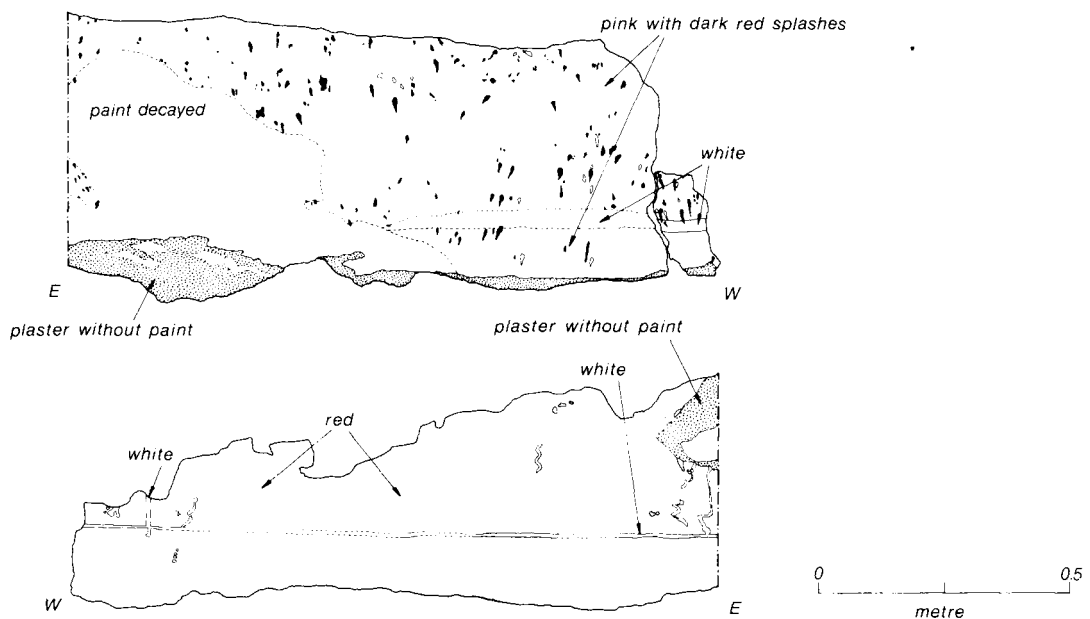


Fig 28 Wall plaster on wall JF312. [Pages 21, 40, & 42]



Fig 30 The system of drains in Building 8. [Pages 40-1]

### The wall plaster from Building 8

by Roger Ling

The only building at Lion Walk which yielded painted wall plaster of any quantity or any interest was Building 8, which predates the Boudican destruction of 60/61.

The surviving stub of daub wall JF312 carried the lower part of painted dados on each face (Fig 28, p41). On the north face the dado was pink and spattered with white and dark red splashes in imitation of marbling, a common decorative device for this part of the wall decoration; there was also a hint of a horizontal white line 80 mm above the floor-level. On the south face the dado had a red ground decorated with white squiggles, a somewhat less common means of producing the appearance of marbling; a horizontal line again ran about 80 mm up from the floor.

The remaining wall plaster was recovered in fragments. The statistical table (Appendix 6, Table 1, microfiche) shows an overwhelming preponderance of red, and numerous pieces indicate the presence of at least one decoration of the familiar type known from Boxmoor, Cirencester and elsewhere<sup>1</sup>, ie a series of large red fields framed by green borders and alternating with vertical black fasciae. The green borders (at least 45 mm wide) were outlined, as usual, by white stripes, and there were white border-lines

inside the red fields. Whether the black fasciae were, as often happens, decorated with candelabra of some form is uncertain; one black fragment seems to show a pair of pointed white leaves, but there is no other trace of decoration on a black ground. One of the red ground fragments, however, carries part of a white garland, suggesting that not all the fields were plain.

Decorations of this form are normal in Flavian and Trajanic times, but have not been hitherto attested before 60; the Colchester example therefore pushes the date of their first appearance back at least as far as the early years of Nero, a time when the bulk of wall-painting in Britain would presumably have been carried out by immigrant decorators. The standard of execution is high, as in most 1st-century work; the surface is well burnished and the colours smoothly and evenly applied.

#### Note

1. Davey & Ling 1982, 82-4 no 2, 97 no 8, 145 no 28. ■

### The bed

[Plan Fig 32, p44; photographs Fig 33, p45; weaving draft Fig 34, p46]

Tucked neatly in the corner of a room in Building 8 were two rectangular mattresses, one on top of the other. These measured 1.92 x 0.97 m (6ft4 in x 3ft2 in) and thus were almost exactly twice as long as they were wide. The nature of the furnishing concerned is not certain but probably it had been a bed rather than a couch because of its shape and position in the room and because the lower mattress seems to have lain directly on the floor (*see below*). Each mattress consisted of a casing made of cloth woven in 2-over-2 diamond twill and filled with an unidentifiable stuffing. On top of the upper mattress had been at least two separate fabrics woven in plain weave. Little of these survived but they probably were either blankets or one or more loose covers depending on whether the furnishing had been a bed or a couch. The furnishing had caught fire during the Boudican revolt and part survived in carbonised form. In the heat, the stuffing became rather bubbly and was considerably distorted in contrast to the covers which in places were left perfectly preserved as carbon. The surviving stuffing was no more than about 20 mm thick but, because of the effects of the fire, this probably bears little relation to the original thickness of the mattresses. The fabric used for the the stuffing could not be determined although at least some of the cloth seems to have been wool (*see below*).

Two pieces of carbonised timber survived in the vicinity of the textiles (Fig 32). One lay over the remains of the textiles at an odd angle and almost certainly was unconnected with the furnishing. The other piece lay parallel with the eastern edge of the furnishing and not far from it. This timber may have been part of its frame had this existed.

Under the remains of the lower mattress was some carbonised rope (Fig 33) set in the surface of the daub floor. The rope must have been pressed into the floor

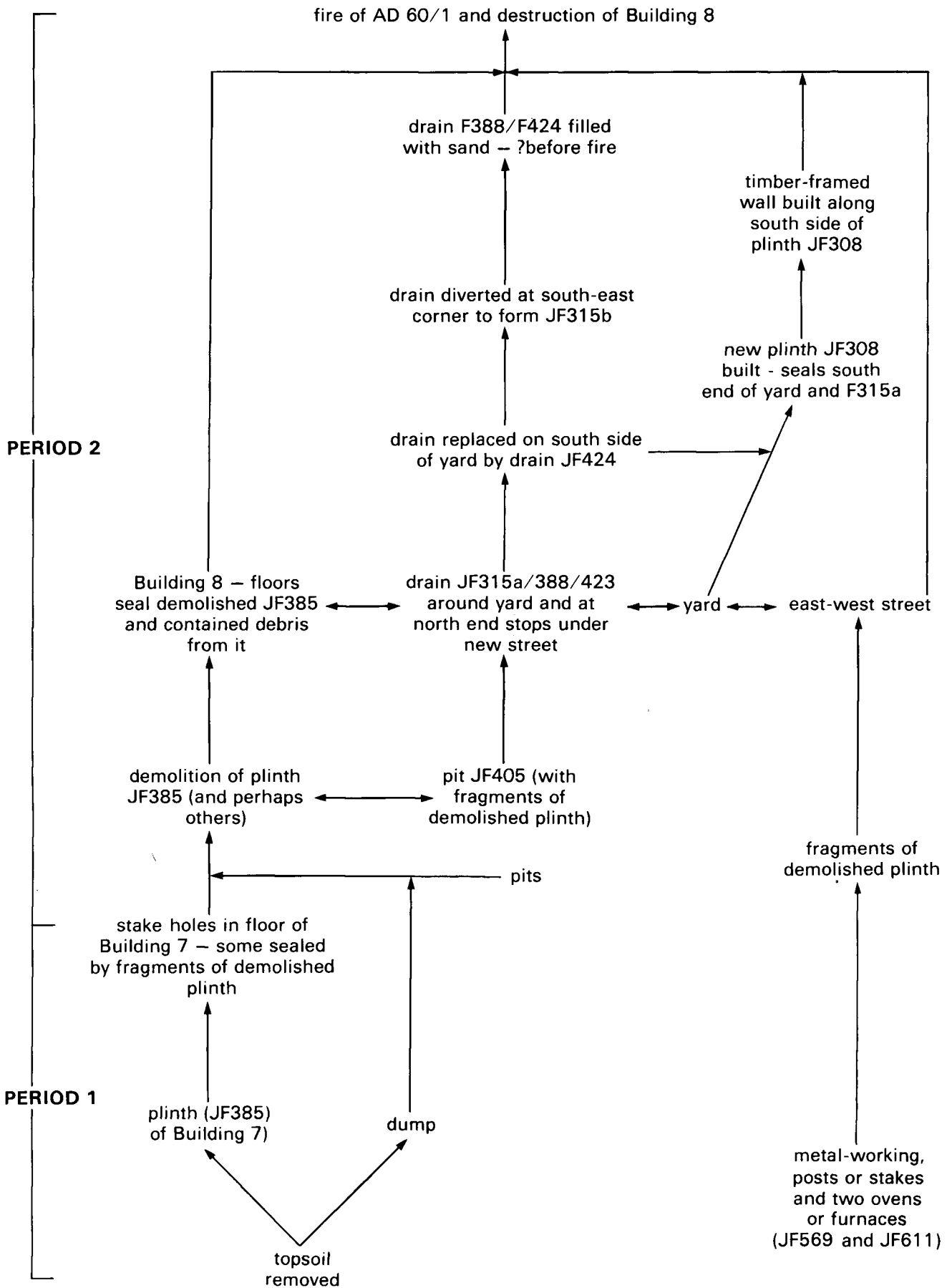


Fig 31 Flow diagram for alterations to Buildings 7 and 8. [Pages 35-6 & 40-2]

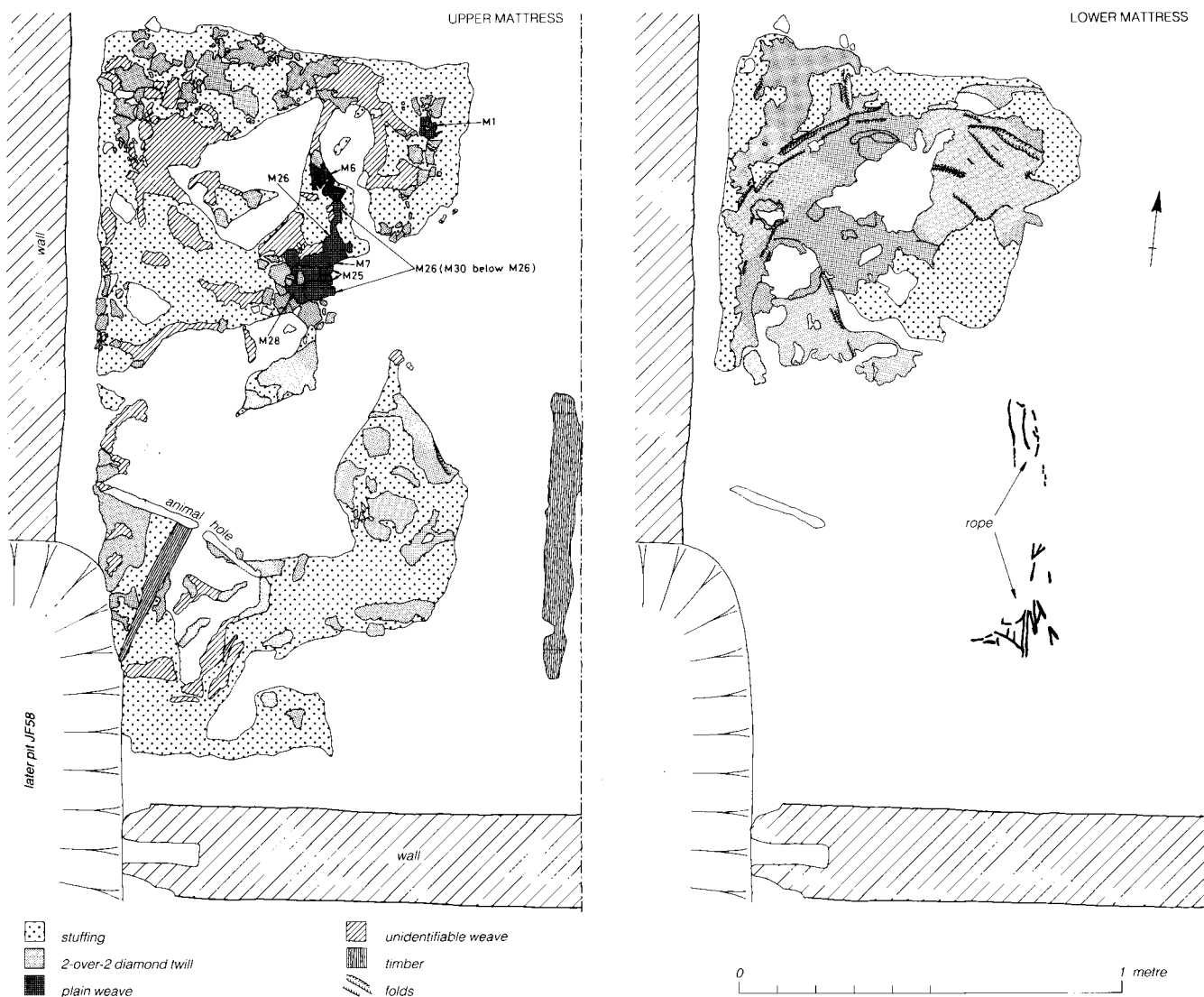


Fig 32 The remains of the burnt bed in Building 8. [Pages 42-7]

before the fire since the remains were too delicate for this to have happened afterwards. The relationship of the rope to the floor was very clear and showed that the lower mattress must have lain very close to the floor if not directly on it. The fact that the rope survived only at the east side of the bed may indicate the area of maximum use of the furnishing. If so, then this would be consistent with people sitting along this edge. The rope may have been unconnected with the furnishing and was simply stored underneath it. Alternatively it may have been part of a rope webbing which was fixed to a wooden frame to support the mattresses. If this had been the case, then to judge by the position of the carbonised rope, the web must have disintegrated long before the fire so that the lower mattress lay on the floor.

The textile and other fragments were planned on the site and then lifted in small groups according to area and type. As much as could possibly be lifted intact was kept. The positions of all of the groups were recorded on a large-scale plan and each group was given a reference number prefixed by 'M'. For the sake of clarity, only the positions of the fragments of

plain weave are shown in Figure 32. Other fragments were found scattered in surrounding later layers and features; these were recorded differently.

**The textiles**  
by John Peter Wild

We owe our knowledge of the textiles from Lion Walk to the Boudican fire which swept through the building in which they lay. The cloth, together with the presumed stuffing beneath it, was carbonised and so preserved; but it is now extremely brittle. The upper surface of many fragments has a glazed appearance, but where the cloth was protected from direct heat, its form is preserved with little obvious distortion.

The textile fragments stem from not less than three — and perhaps as many as five — separate fabrics. There is also a length of rope. Briefly, they are as follows:

- 1) 2-over-2 diamond twill (M2-5, probably M6-7, M8-10, M12-41, and uncoded samples JPW 2, JPW 6, & JPW 7)
- 2) fine plain weave (M6)

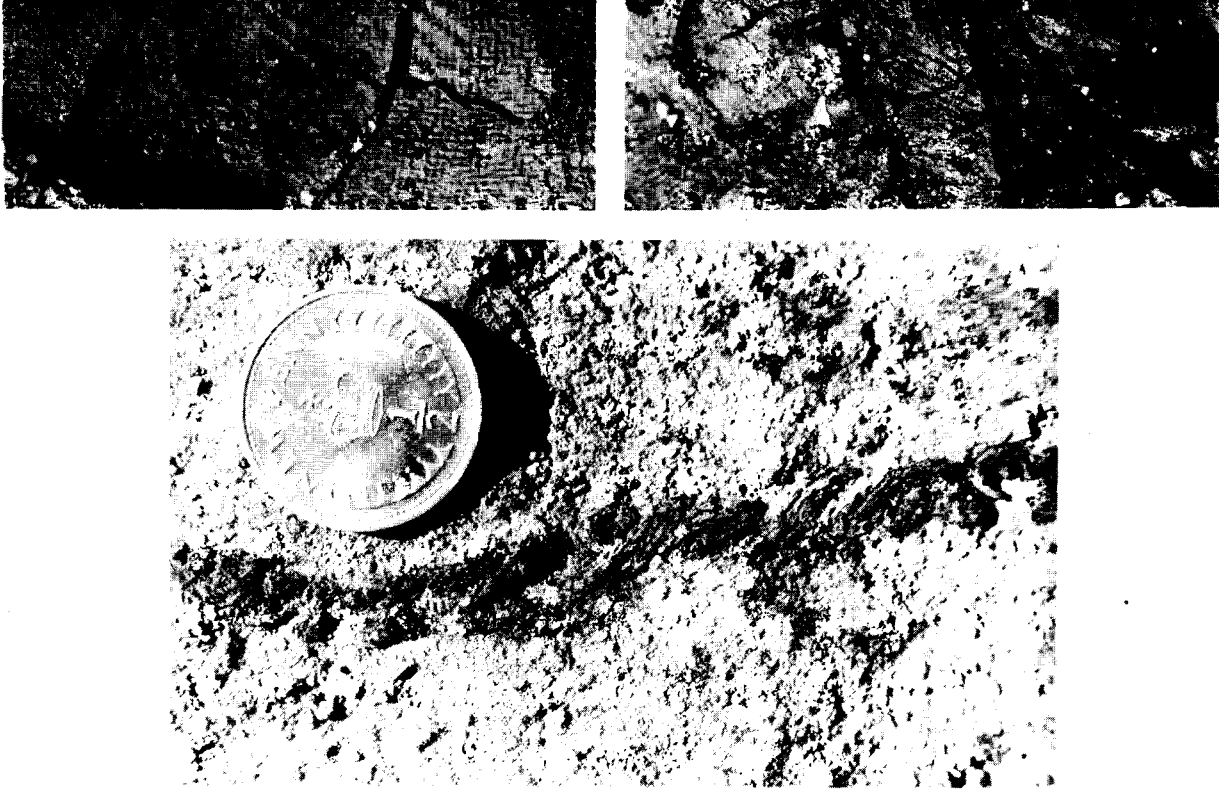


Fig 33 The textiles of ?bed. Above left: Textile No 1; above right: Textile No 5; below: rope. [Pages 44-7]

- 3) medium-fine plain weave (M7)
- 4) medium-fine plain weave (M1)
- 5) plain weave (M25, M26, M28, & M30)
- 6) fragments of fine rope (M13 & an uncoded sample).

*Technical details*

- 1) the 2-over-2 diamond twill (Fig 33)

One fragment of textile (JPW 6, uncoded) was sufficiently clear for a weaving draft to be made (Fig 34). Two more fragments (M27 & M31), although smaller, confirmed the draft and the character of the yarns and weave. System 1 is Z-spun, with about 7 threads per 10 mm (9-10 in JPW 6) while system 2 is

Z-spun, with 9-10 threads per 10 mm (10-12 threads in JPW 6). The yarns, which optically appear to be of wool, are regular and fairly hard-spun. The same yarn was probably used for both thread systems, but in system 1 (? weft) the threads are more widely spaced than in system 2 (? warp). There is full displacement in both systems and the direction of the weave changes after nine threads of system 1, fourteen threads of system 2. The diamond twill extended over an area measuring at least approximately 1.90 x 0.95 m. While folds and creases were noted in its surface, petrified by the heat, no original edges or selvages survive for study.

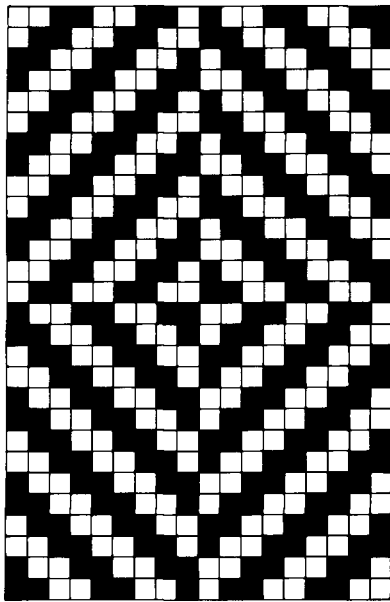


Fig 34 ?Bed: weaving draft of the diamond twill. [Pages 44-7]

#### 2) fine plain weave

Sample M6 consists of about 1000 sq mm of fine plain weave, folded upon itself to give five or six thicknesses of cloth. It is attached to a single layer of diamond twill, which in turn overlies the carbonised 'stuffing'. It appears to be wool. System 1 is Z-spun, with about 25 threads per 10 mm and system 2 of spin uncertain has about 10-12 threads per 10 mm. System 2 is widely spaced and is invisible beneath the yarn of system 1.

#### 3) medium-fine plain weave

Several layers of folded plain weave in Sample M7 amount to about 1000 sq mm. They overlie a thicker fabric (probably diamond twill), which itself is attached to carbonised 'stuffing'. System 1 is Z-spun, with about 15 threads per 10 mm (but much distorted) and system 2 of uncertain spin has about 15 threads per 10 mm.

#### 4) medium-fine plain weave

Sample M1 consists of about 400 sq mm of a plain weave. System 1 of uncertain spin has about 10 threads per 10 mm and system 2 also of uncertain spin has about 12 threads per 10 mm.

#### 5) plain weave (Fig 33)

Four fragments (M25, M26, M28, & M30) show over 100 sq mm of a plain weave, folded over upon a layer of diamond twill. System 1 is fairly hard Z-spun, with about 14-15 threads per 10 mm and system 2 is Z-spun, with about 12 threads per 10 mm. The yarns are of varying thickness, unevenly spun. The plain weaves, nos 3, 4, and 5 above, could perhaps come from a single web of (? wool) cloth, with a maximum count of about 15 threads per 10 mm. They are quite distinct, however, from the plain weave no 2, in which the one thread system covers the other.

#### 6) the rope (Fig 33)

Lengths of a fine rope (M13 & an uncoded sample) were found under the lower mattress. The rope consists of three strands (each about 2 mm thick), S-plied from weak Z-spun yarn.

#### Discussion

Assuming a production date not long before AD 60, the 2-over-2 diamond twill is the earliest dated example of this weave from the north-west Roman provinces. There is an isolated late Bronze Age diamond twill from Gerumsberg (Sweden), but that is an accident in an otherwise herringbone twill cloth (von Post *et al* 1925, 27-32; La Baume 1955, 100-3). Both warp- and weft-chevron twills were regularly woven in the Iron Age, as the finds from the Hallstatt and Dürrnberg salt-mines indicate (Hundt 1970) but the only pre-Roman Iron Age diamond twill that I know of comes from Burton Fleming in East Yorkshire.<sup>1</sup> Nevertheless, the ability to weave diamond twill was probably more widespread than this single instance would suggest. Certainly by the late Flavian period diamond twill is a very common weave in North Britain, as the textiles from Corbridge (Wild 1970, 98-9) and Vindolanda (Wild 1977) prove.

The quality of the Lion Walk diamond twill is good, and the regularity both of the weave and of the spun yarns is notable. It matches two diamond twills from Corbridge (Wild 1970, 98), but is not so fine as the twill from Balmaclellan<sup>2</sup> or that from Verulamium<sup>3</sup>. The Z spin-direction in both thread systems indicates that the diamond twill was produced in western Europe — quite probably in Britain (Wild 1970, 38).

The plain weaves call for no special comment. They can be readily paralleled in both wool and linen in the Roman provinces. It seems probable that the textile material described above was *in situ* when it was carbonised, and it should not be regarded, for example, as a fallen wall-hanging, but rather as some form of horizontally laid soft furnishing.

The main surviving textile, the 2-over-2 diamond twill no 1 (Fig 33), was found to overlie a layer of carbonised matter which had been severely distorted by heat. This material, which has been described above for argument's sake as 'stuffing', was preserved over a wider area than the textile.<sup>4</sup> In some cases it was covered (on the upper side only) by two layers of twill; but this may be a result of the folding and creasing which was evident in the material during excavation or the twill concerned could have been parts of both mattress covers where these were in contact. The 'stuffing' was submitted to Dr G E Cusick of the Department of Textile Technology in the Manchester University Institute of Science and Technology for study. After examining the material under the scanning electron microscope, microphotographs were taken of areas which appeared fibrous in nature. The state of preservation was such, however, that he was unable to learn anything of the type of fibre used, even from the most informative photographs.<sup>5</sup>

The plain-weave cloth was concentrated at two

points on the northern part of the main textile feature, and directly overlay the twill. It may represent loose covers or similar small items, while the diamond twill was an integral part of the soft furnishing.

Mattresses covered in 2-over-2 twill are not attested in any other source, but cushions covered in 2-over-1 twill formed part of the Trajanic hoard from Corbridge.<sup>6</sup> The fabric 2-over-1 twill, however, is a pattern-weave, in which colour-effects are possible, and so it would be a more natural decorative medium than 2-over-2 twill.

While the precise character of the soft furnishing under discussion is not clear, it is worth remembering that the Romano-British textile industry was renowned for woollen rugs or coverlets. The *tossia Britannica*, first attested in 220<sup>7</sup>, may be identical with the *tapete Britannicum* listed in the Edict of Diocletian (AD 301)<sup>8</sup>. Both had a variety of uses, and both were of high quality.

#### Notes

1. This information was very kindly communicated to me by Miss E Crowfoot, who is to publish it.
2. Wild 1970, 98; *Proceedings of the Society of Antiquaries of Scotland*, **82** (1947-8), 225-7, fig 1, pl 42 a & b.
3. Wild 1970, 99; *The Hertfordshire Archaeologist*, **1** (1968), 9-50.
4. Mr Philip Crummy provided me with copies of the relevant plans of the find.
5. I am most grateful to Dr G E Cusick for undertaking this research.
6. Wild 1970, 101, no 50; *Archaeologia Aeliana*, **46** (1968), 4th series, 115-26.
7. *CIL*, **13**, 3162 col 2; *Bonner Jahrbücher*, **168** (1968), 228; *Etudes celtiques*, **11** (1966-7), 409-12.
8. *Edictum Diocletiani*, **19**, 28; S Lauffer, *Diokletians Preisedikkt*, 1971, 265; A Wace, 'Tappeto', *American Journal of Archaeology*, **76** (1972), 438-40. ■

#### The ?bed

by Joan Liversidge

The remains of a 1st-century bed found at Colchester are of unique interest. Discrimination between Roman beds and couches is not easy and both can be either a small distance above ground level or else high enough to be reached only with the aid of a footstool. Many examples appear on stone reliefs depicting funeral banquet scenes and these include mattresses of varying thickness (Liversidge 1955, 3-15, pls 1-13). Normally only one mattress is shown, but the deceased on the monument of the Haterii in Rome is laid out on two substantial examples, one above the other (Richter 1966, fig 350). Little evidence for bedding survives from the couch or bed remains from such sites as Herculaneum.

Mattress covers with woven decoration are known from both reliefs and wall-paintings and coverings were used either as luxurious accessories on elaborate couches<sup>1</sup> or to conceal roughly made or very plain beds (Ransom 1903, 66). Cushions are also frequently depicted. Mattresses and cushions were stuffed with wool, straw, reeds and other vegetable material or feathers (*ibid*, 70). The cushion identified with the remains of a folding stool from the barrow burial at Holborough, Kent, may have been stuffed with chaff (Jessup 1954, 23). Traces of feathers and

wool were found with the burnt remains of a bed at Beckfoot, Cumbria (Bellhouse 1954, 52).

While the Colchester mattresses may have lain on the ground or even represent bedding for two people piled out of the way during the daytime, the piece of wood found further east might be part of the frame of a low bed filled in with a webbing of rope or strips of leather. The frame of such a bed carried on a man's back appears on catacomb paintings depicting the Healing of the Paralytic in the Catacombs of Callixtus and Peter and Marcellinus in Rome (Stevenson 1978, figs 42 & 64).

#### Note

1. For example, the Courtship of Venus and Mars, A Maiuri, *Roman Painting* (1953), 78. ■

## Building 9 (Period 2)

[LWC Site B; general plan Fig 23, p39; detail plan Fig 24, Sheet 1a]

Building 9 (Figs 23 & 24) lay along the western frontage of the street which had been built over the backfilled north-south ditch. It had timber-and-daub walls and no mortared plinths. Charcoal fragments of two ground-plates (BF250 & BF253) survived and along the side of the street was an oak-lined drain (BF150) (Sx 9, microfiche) which contained a human mandible in its backfill (Appendix 1, microfiche). These features were all burnt in 60/1. On the west side of the drain was another slot (BF151) (Sx 9, microfiche) of uncertain purpose. Probably this had contained the ground-plate of a framed wall. There was also an east-west timber-lined drain (BF251). This had not been charred by the fire because it was underground and thus not exposed to the air. The drain sloped gently down to the east passing first under the floor of Building 9 and then under the north-south drain and slot. It stopped below the earliest metalling of the north-south street and in the backfill of the military ditch.

The daub floors of Building 9 contained fragments of white painted wall plaster and thus must have derived from the demolition of at least one building. However no structural remains of any building were found under Building 9 so that the material for its floors had presumably been brought from elsewhere. Pit BF144 contained many fragments of burnt daub blocks (p22; Sx 5, microfiche) showing that the pit had been open during the revolt and that Building 9 had incorporated at least one block wall.

The northern limit of Building 9 is probably indicated by the north ends of the drain BF150 and the slot BF151 since these both terminated together. This corresponds to the line projected eastwards of the south face of the south wall of the later Roman cellar (BF70, p66) and thus almost certainly demarcates a property boundary which not only related to Building 9 but which also survived the major rebuilding operations after the fire.

Whether any substantial structure occupied the plot immediately north of Building 9 could not be



FIG 36

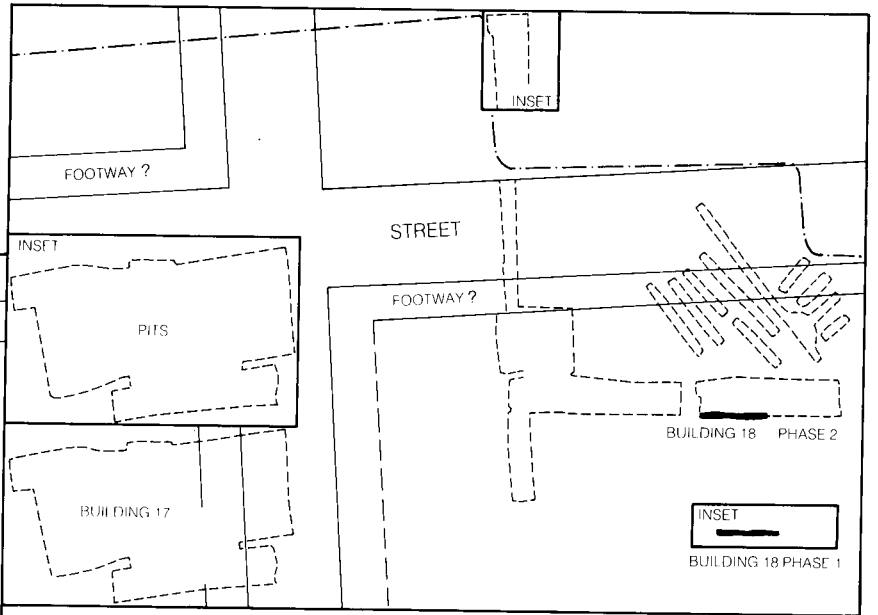


FIG 37

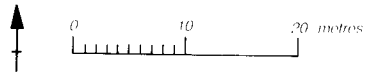
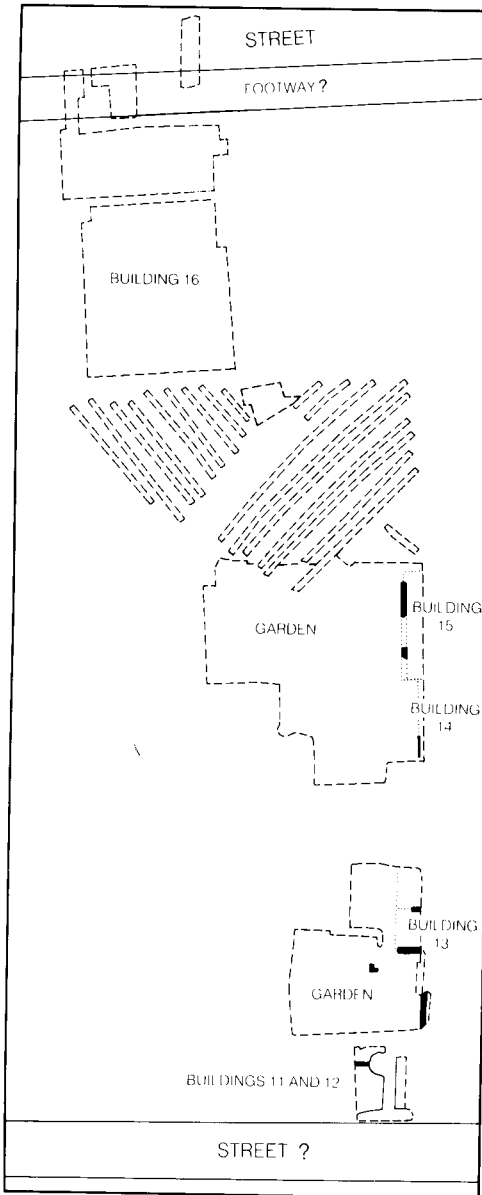


Fig 35 Lion Walk AD 60/1-c 100: general plan. [Pages 49-52]

established since this area had been destroyed when the cellar was built.

### Building 10 (Period 2)

[LWC Site A/R; general plan Fig 23, p39; detail plan Fig 24, Sheet 1a]

Some small pits, stake holes and two slots found on Site A/R are described here as Building 10 although more than one structure may be involved (Figs 23 & 24). No floors or occupation of this period survived but the walls were represented by a spread of burnt daub blocks in the Boudican debris (Sx 1, microfiche). These had not come from the revetment of the rampart since not only were they of a different size but also they contained vegetable tempering. Over the top of the demolished rampart were some stake holes, two slots, two small pits and a burnt patch of daub *in situ* (RF89). The absence of occupation of this period (Sx 59, microfiche) is probably the result of the uppermost levels having been removed when the next Roman building on the site was constructed.

### Building 11 (Period 3a of Site L)

[LWC Site L; general plan Fig 35, p48; detail plan Fig 37, Sheet 1b; large-scale plan Fig 22, p38; hearth Fig 38, p49]

Building 11 (Figs 22, 35, & 37) was probably little more than a hut dating from c 85 to c 90. It was

built over the garden in use since Period 2 (Sx 52, microfiche). The building extended beyond the area of excavation on all but the north side where there was a slot (LF264) and two shallow grooves (LF257 & LF258) probably left by two horizontal wattles in a wall. Apparently inside Building 11 and contemporary with it was a forging hearth LF267 (Fig 38). The remains of this took the form of a hard, well burnt, flat patch on the floor which was associated with fragments of hammer-scale, forging slag and furnace lining. The pattern of burning showed that the furnace had been in the shape of an irregular circle measuring 0.8-1.0m externally. The mouth was on the south-east side and was 0.25m wide. The floor of the furnace had been formed with broken roof tiles laid flat. The furnace had been rebuilt several times, the exact number not being clear. To the south-east were some stake holes, a few of which were square. An examination of Section 52 shows that the furnace may have post-dated Building 11 and thus could have been outdoors. However the occupation around the furnace is thick and consistent with indoor accumulations of this type elsewhere.

### Building 12 (Period 3b of Site L)

[LWC Site L; general plan Fig 35, p48; detail plan Fig 37, Sheet 1b; large-scale plan Fig 22, p38]

Building 11 was demolished and probably replaced shortly afterwards by Building 12 (Figs 22, 35, & 37).

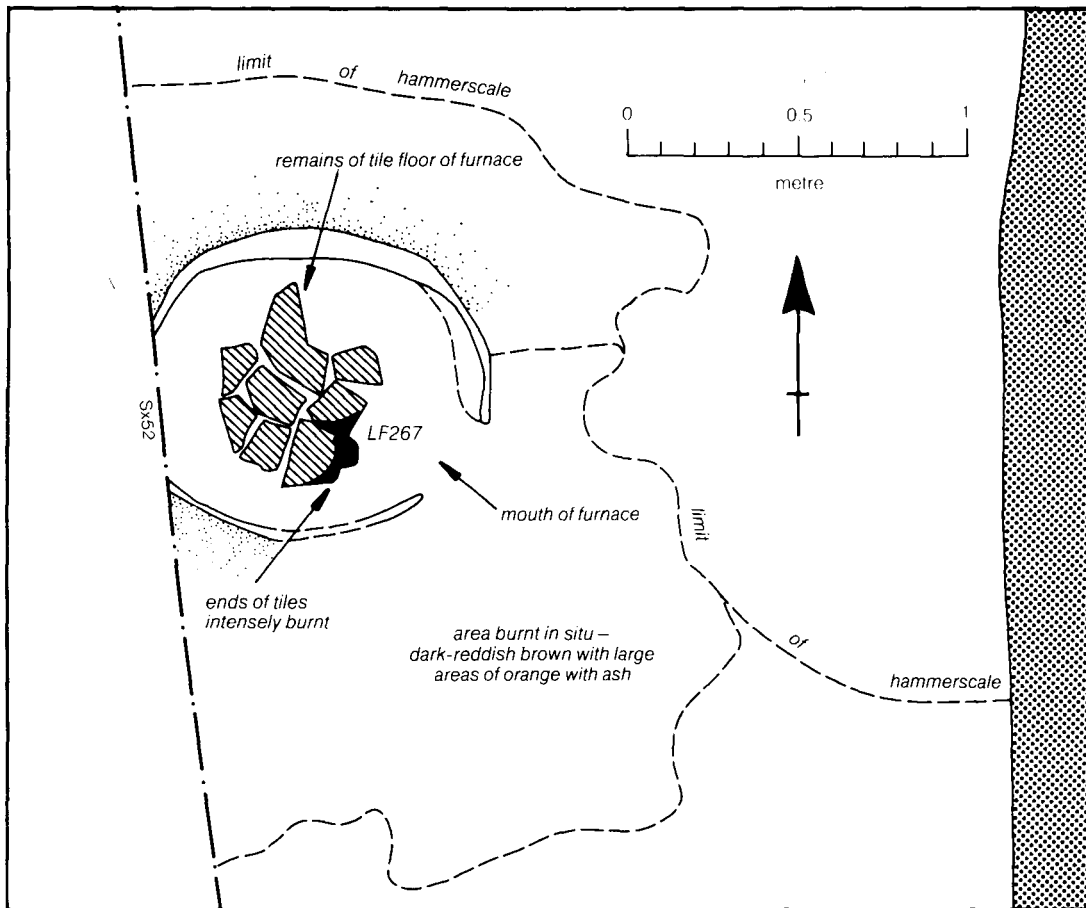


Fig 38 The forging hearth LF267 in Building 11. [Page 49]

The new building dated from *c* 90 to *c* 100 and, like Building 11 before it, extended beyond the limits of the excavation except on the north side. The structural remains consisted of the bases of two daub block walls (LF247 & LF248), many stake holes and part of another daub block wall (LF250) with an adjacent square posthole (LF253). An intensely burnt patch (LF254) corresponded closely but not exactly to the position of the earlier forging hearth and may have been all that remained of a replacement for it. The earliest levels contained the remains of a nest in the form of a patch of straw with fragments of at least three egg shells (Fig 22). Some of the stake holes may have been part of a structure over the nest.

### Building 13 (Periods 3a & 3b of Site C)

[LWC Site C; general plan Fig 35, p 48; detail plan Fig 37, Sheet 1b]

Building 13 (Figs 35 & 36) is regarded as having been of two phases (Periods 3a & 3b) on the basis that the timber drain CF209/220 cut the Period 1/2 plinth CF240 and thus post-dated Period 2 but was itself cut by the Period 3 foundation CF219. In the parts of the site not linked stratigraphically with the drain, no distinction can be made between Periods 3a and 3b. Also it is possible that what is described as Building 13 was in fact two buildings, one to either side of foundation CF219.

The floor in the north-east corner of Site C was burnt and contained several shallow slots (CF168 & CF169). The slot CF190 was possibly not a feature but was the result of distortion caused by settlement into the post-Roman pit CF88. South of the foundation CF219, the only structural feature was the foundation CF238 (Sx 21, microfiche). This appeared to have supported the rear wall of the building and coincided with a wall of Building 19 of Period 4. To the west of CF238, the area was covered with cultivated soil and had clearly been a garden although there was a curious shallow foundation (CF197) made of septaria set in sand, which is hard to explain in terms of plan. The garden may have been an area of cultivation since *c* 49 (p37). Its relationship with Buildings 11 and 12 and the underlying cultivated soil of Period 2 was very distinct and is well illustrated in Section 52 (microfiche). A pit (CF210; Sx 11, microfiche), two smaller pits and a slot were dug in the garden. The timber drain CF209/220 narrowed to the south and was laid to fall in that direction.

### Buildings 14 and 15 (Period 3 of Site K)

[LWC Site K; general plan Fig 35, p 48; detail plan Fig 37, Sheet 1b]

Several shallow scoops (KF226, KF234, KF251, KF255, & KF245) just penetrated the surface of the Period 2 floors and were dug during the post-Boudican rebuilding works when efforts were made to reach the pre-Boudican ground level (Fig 37). Despite this activity, there was a thick deposit of redistributed Boudican debris over all of Site K especially at the south end where it was up to 0.6 m deep (Sx 49, microfiche). In Section 48 (microfiche),

the debris was preserved because of the extensive settlement which occurred here into a Period 1 pit.

The Period 3 remains on Site K probably represent two buildings of which only the extreme west ends were found (Figs 35 & 37). This is because the backs of the buildings did not line up with each other. The break corresponded with the position of the party-wall between the Buildings 4 and 5 of Periods 1 and 2 as if this marked a property boundary which survived the Boudican fire. The buildings fronted on to the east side of *Insula* 36 and therefore were about 25 m long.

The precise position of the back wall of Building 14 was not clear since it had been mostly destroyed. Similarly the exact extent of the floors was not apparent. The building may have extended back to include the area later covered by the large mosaic in Building 19 although any occupation here, if it ever existed, had been removed during construction work of Period 4b (Sx 49, microfiche). The floor of one room contained several stake holes and patches of mortar and part of a burnt ground-plate which was under a section of daub wall (KF135); both were *in situ*.

The back wall of Building 15 was clearly demarcated by a shallow unmortared foundation (KF225 & KF103) and the base of a daub wall (KF102). The latter had painted plaster *in situ* on its east face. To the south were three successive ovens (KF204, KF205, & KF206; Sx 44, microfiche). Perhaps this was a kitchen?

To the west of the back wall of Building 15 was a garden (Sx 47, microfiche). The mortared plinths of the Period 1/2 buildings had been partly robbed in Period 3. The north plinth of Building 5 had been removed in the area of the garden but not under or east of the rear wall of Building 15 thus showing that the robbing took place when Building 15 was in existence. The fate of the plinth between Buildings 4 and 5 is not clear since the plinth had been destroyed, if not when Building 19 was constructed, then during the early medieval robbing. The pit KF343 was oddly placed since it lay on the line of the party-wall between Buildings 14 and 15. The explanation for this is obscure. Other trenches (KF287, KF168, & KF161) occurred in the garden area; these were presumably dug in search of plinths.

### Building 16 (Period 3 of Site J)

[LWC Site J; general plan Fig 35, p 48; detail plan Fig 37, Sheet 1b; large-scale plan Fig 39, p 51]

No walls of Building 16 (Figs 35 & 37) were found apart from those in the south-west corner where there was a gravel-and-tile foundation which survived only in section (Sx 40, microfiche). Also foundation JF417 (Sx 31, microfiche), which was on the line of the later Period 4b foundation JF155, belonged to Building 16 or was of Period 4a. Individual rooms could not be clearly discerned.

Like Building 19 which succeeded it, the room(s) on the frontage of Building 16 were workshops (Fig



Fig 39 Building 16, room(s) at street frontage. 1:60. [Pages 50-2]

39). They contained three small structures: a tile hearth (JF510), a strip of intensely burnt daub, and a furnace for bronze-working. The tile hearth (JF510) had to the west a heavily burnt patch of daub cut by stake holes. Probably the hearth was of several phases so that the tiles were first, the burnt patch second and the stake holes last. The form of its superstructure is obscure but it probably incorporated the group of broken tile (JF509) found to the north of the hearth. The second small structure, the strip of intensely burnt daub, had been cut to the north and south by later features. It was thus too badly damaged to establish its plan or purpose. The plan of the bronze-working furnace (J1600 + J1601 + J1651) was also unclear. The remains consisted of an irregularly shaped patch of intensely burnt daub and some stake holes. The furnace belonged to a date early in Period 3 since it had been built directly on top of redeposited Boudican debris. Associated with the hearth were some crucible fragments (Appendix 7, p214), forging slag, furnace lining, ?Flavian samian, and a coin of 64-8. Since the coin was found with slag and furnace lining, it does not provide a date after which the furnace was built. This is to be placed c 60/1-75. To the south of the workshops were some stake holes, pits and gullies.

### Building 17 (Period 3 of Site B)

[LWC Site B; general plan Fig 35, p48; detail plan Fig 36, Sheet 1a]

The floors of Building 17 (Figs 35 & 36) were made with well-mixed Boudican debris laid to form floors 0.1 to 0.2 m thick. The plan of the building is obscure. Traces of what appeared to have been ground-plates were found on the east sides of BF152 and BF153 and elsewhere there were posts and post-pits. Also some gravel-packed post-bases (BF155, BF156, BF167, & BF172) formed a rough north-south line parallel with the street. These were 0.2 m or so deep and seemed to be replacements for earlier posts since some of the bases sealed the bottoms of postholes. Features BF161 and BF154 were narrow road-side gullies of uncertain origin. They may have been wheel ruts, drainage gullies, or channels formed by storm water. The west limit of Building 17 is unclear but probably it lay beyond the west side of Site B. The north limit was presumably the same as that of Building 9 assuming that the property boundaries survived the Boudican fire. In the north-east corner of the site was a mortar floor and six rows of stake holes laid out as two rows of three. These remains hint at the presence of a building to the north of Building 17. However little survived of this because its site had been destroyed when the cellar BF70 was constructed in Period 5. The mortar floor and the stake holes appear to represent an encroachment on to the street. Alternatively the mortar may have been laid as a repair to the street but as a technique this would be without parallel in Colchester.

After the fire the street itself appears to have suffered neglect. Deposits dumped on it were not cleared away and as already mentioned there is evidence of encroachment (Sxs 2 & 4, microfiche).

After the demolition of Building 17 in c 80/90 and until c 100 (Period 4 on Site B), the plot was used as an area for digging pits and as a midden (Figs 35 & 36). In some cases, it is difficult to distinguish the deposits of Period 4 from those of Period 5 of Site B (c 100 - 350) so that the situation may have been more complex than presented here. However some of the pits and midden deposits contained much pottery of late 1st-century date and some of the pits were sealed by the walls of the Period 5 house (Building 23), ie foundation BF113 seals pits BF195 and BF191, and foundation BF117 seals pit BF223.

### Building 18 (Period 3 of Site A/R)

[LWC Site A/R; general plan Fig 35, p48; detail plan Fig 36, Sheet 1a]

Period 3 on Site A (Figs 35 & 36) represents the time from 60/1 to the start of Period 4 on Site A/R in c 275. Perhaps several structural periods are represented here but the evidence is scrappy, partly because of insufficient excavation, and partly because much was destroyed when Buildings 24 and 25 were constructed. It is also possible that all of what is described as Building 18 was later than AD 100.

Two successive foundations, one on top of the other, are attributed to Periods 3a and 3b respectively (ie Phases 1 & 2). The Period 3a foundation (AF99) was made of large water-worn stones whilst the other (AF97) consisted of blocks of septaria, some of which were unusually large. The foundations were separated from one another by a layer of soil 0.1 m thick. It may be that all three features, ie the two foundations and the layer of soil, were of one period and belonged to a single foundation although this is unlikely because the load-bearing qualities of the soil would have been very poor. The Period 3a foundation sealed the Period 2 feature AF100 including the burnt daub blocks (p49). The other principal remains of Period 3 consist of several pits, some of which (AF85 & AF95) were sealed by tessellated pavements of Period 4.

### Building 19 (Period 4 of Sites C, K, L, Q, & T)

[LWC Sites C, K, L, Q, & T; general plan Fig 40, p53; detail plan Fig 42, Sheet 2b: large-scale plans Fig 43, p55, Fig 44, p56, Fig 45, p57]

Building 19 was a courtyard-house, only the rear range of which was available for excavation (Figs 40 & 42). The house was built c 150 and was of two phases (Periods 4a & 4b), the second being represented by the addition, probably in the 4th century, of rooms along the north side. The new rooms (Rooms 16-9) were on a slightly different alignment from the rest of the house. Also at this time, Rooms 11 and 15 were combined and enlarged slightly by the building of a new north wall. A large figured mosaic (*see below*), which was laid in the new room, thus sealed not only the Phase 1 foundation separating the two earlier rooms but also the foundation which bounded the north sides of these compartments in their Phase 1 forms (Sx 49,

FIG 42

FIG 41



Fig 40 Lion Walk c AD 100-450: general plan. [Pages 52-73]

microfiche). The Phase 1 foundations were robbed in the early medieval period to leave robber trenches KF16 and KF140 respectively. The site on which Building 19 was built sloped to the south (reflecting the pre-Roman landscape) so that substantial quantities of material had to be dumped to make the site level. This can be seen in the sections of Sites C and L. Most if not all of the dumped material seems to have derived from the demolition of the earlier buildings on the site. This is well illustrated in Sx 50 (microfiche) where a snapped post of Period 3 was embedded in the make-up of Period 4. The foundations of the new building had to be very substantial to penetrate these deposits and reach the underlying natural sand. They were at their deepest on Site L (1.5 m) and were made of septaria lumps and mortar laid in alternate layers. No walls survived above foundation level although from the debris which sealed the floors, especially in Rooms 1 and 19, these were probably of daub. It is not possible to say if the walls were timber-framed; they could have been laid in blocks like those of Period 1 (p22).

The principal dating evidence for Building 19 came from the material in the underlying cultivated soil which formed gardens in Period 3 to the west of Buildings 13 to 15. The remains of Building 19 had been badly damaged in places by the extensive digging of pits so that consequently its plan is not easy to reconstruct with any confidence.

Room 1, only a very small part of which was excavated, contained a tessellated pavement.

Room 2 was a kitchen with a fine sequence of structures. Only half the room was examined. Broadly there were three phases of activity, each of which is illustrated (Figs 43 & 44). At first the room contained a tile hearth and a rectangular structure made from fragments of tile bonded with daub. The latter was built against the east wall and survived to a height of 0.3 m. Ash and charcoal had been raked out from inside the structure through a 0.30m gap in the centre of its west side. Thus there had been a fire in it but, although burnt red, the structure had never been hot enough to cause vitrification. Perhaps it had been part of a boiler or something akin to the modern range? The second phase of activity saw at least six ovens in addition to however many were in the unexcavated area of the kitchen. As many as eight ovens may have been found but several had been too badly damaged for positive identification. Not all the ovens were contemporary and the probable sequence is shown in Figure 43 as far as the surviving stratigraphic relationships would allow. The clearest ovens were those with the characteristic key-hole shaped pit. The others were less distinctive but all were small pits with scorched edges. The oven LF183 had a fragment of tile placed horizontally in the centre. Also a tiny bit of its daub superstructure survived. Many stake holes were associated with this phase. Finally in Phase 3, a considerable depth of occupation accumulated on the floor, some pits appeared, and later a ?hearth was built (Sx 52, microfiche). The tile hearth just appears in section and continues off to the west into the unexcavated

part of the kitchen. Important is a 3rd-century radiate coin from the kitchen floors (Sx 52, microfiche); the coin shows that the third phase could not have started before the late 3rd century.

The floor of Room 3 had been completely destroyed but there were two lumps of mortared stone which appeared to be the remnants of a robbed feature (Fig 42). Probably the room had a hypocaust and the mortared stone was the remains of an east-west ?drain as in Rooms 16 and 18. The extreme south-west corner of Site C was outside the building. Here the small pit CF188 contained many fragments of roof tile (Sx 20, microfiche) which presumably originated as tumble from eaves overhead. Room 4 had almost been completely destroyed but patches of tessellated pavement survived *in situ*. Room 5 contained an extensively robbed hypocaust (Sx 13, microfiche). The robber debris contained fragments of box-tile and a few mosaic cubes which probably derived from a destroyed mosaic.

Rooms 6 and 7 had also been badly damaged and the nature of the floors was not clear although they do not seem to have had hypocausts. Rooms 8, 9, and 15 were very small and may have functioned in part as passages. Both Room 9 and Passage 4 had tessellated pavements; the remains are tentatively interpreted as representing two compartments because the rows of tesserae in their pavements had been laid in opposite directions. The floor of Room 8 was destroyed by pit-digging in the post-Roman period. Only the bases of the foundations of Room 8 are shown in plan (Fig 42).

Room 10 had a tessellated pavement. The floor of Room 11 had been stripped out so that the redeposited destruction layers of Period 2 were exposed and the bed for the large figured mosaic was laid directly on top. The character of the floors of Rooms 12, 13, and 14 is unknown but probably these were of daub. Certainly, to judge by the height of the surviving remains, no hypocausts had existed in these rooms. The floor of Room 15 was largely unexcavated although as far as could be judged it had been destroyed.

Rooms 16 and 18 were badly robbed hypocausts of similar design. Each had *pilae* of tile built on an *opus signinum* base which sloped towards the centre where there was a rectangular-sectioned channel formed of tile. These were probably drains. The stoke hole at the end of the channel in Room 18 (Fig 45) contained many fragments of broken roof tile which had presumably slipped from the roof some time after the abandonment of the building. Contained in the debris were many lumps of mortar some of which preserved clearly the curved shape of the imbrices which they had held. Probably a similar stoke hole lay at the end of the channel in Room 16 but this part of the site was not excavated. The most intact part of these hypocausts is shown in profile (Sx 45; microfiche).

Room 17 was small and could have been a cross passage providing a link between Rooms 16 and 18. Although destroyed by post-Roman erosion, its floor

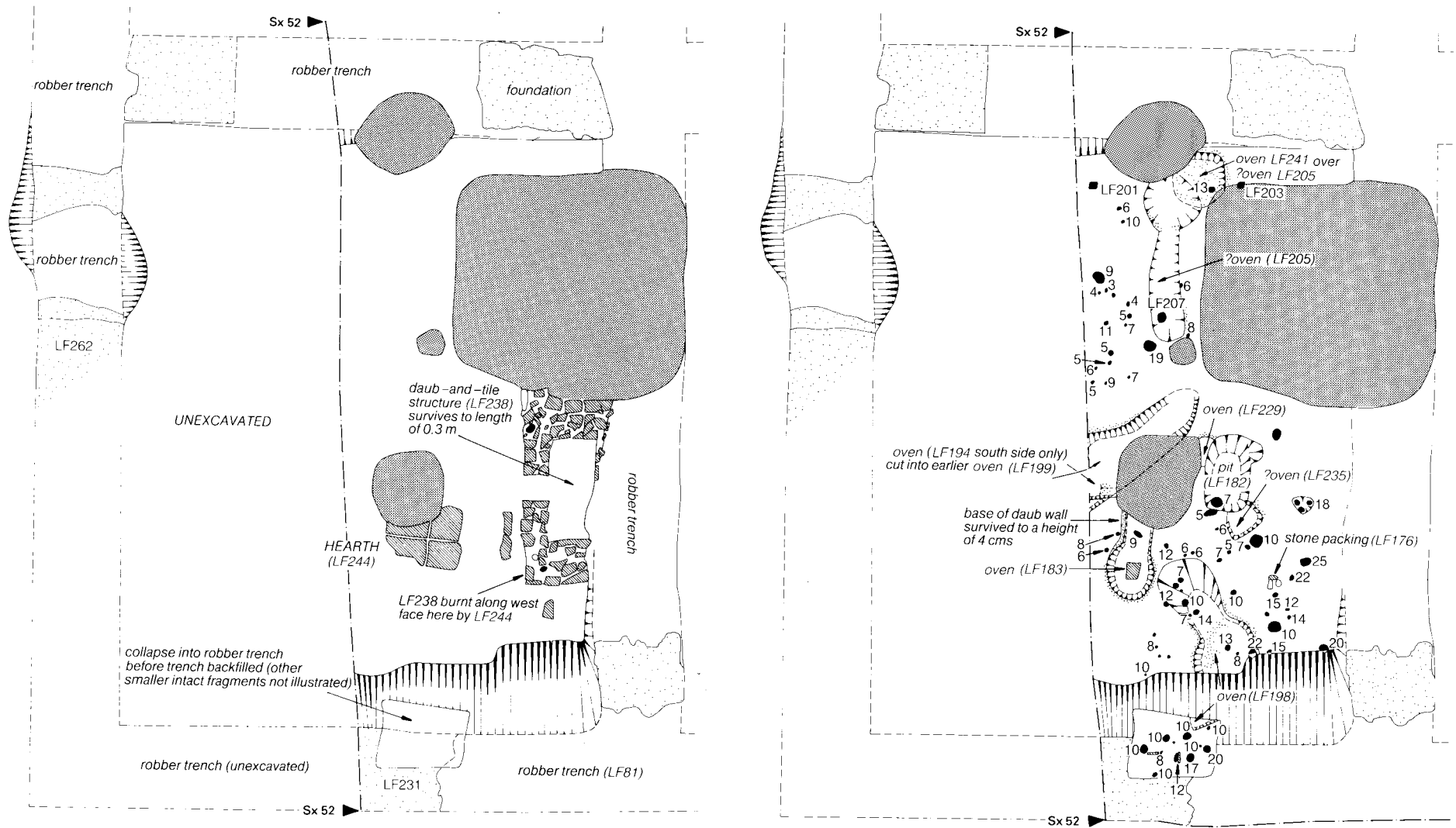


Fig 43 Room 2 of Building 19, Phases 1 (left) and 2 (right). 1:60. [Page 54]



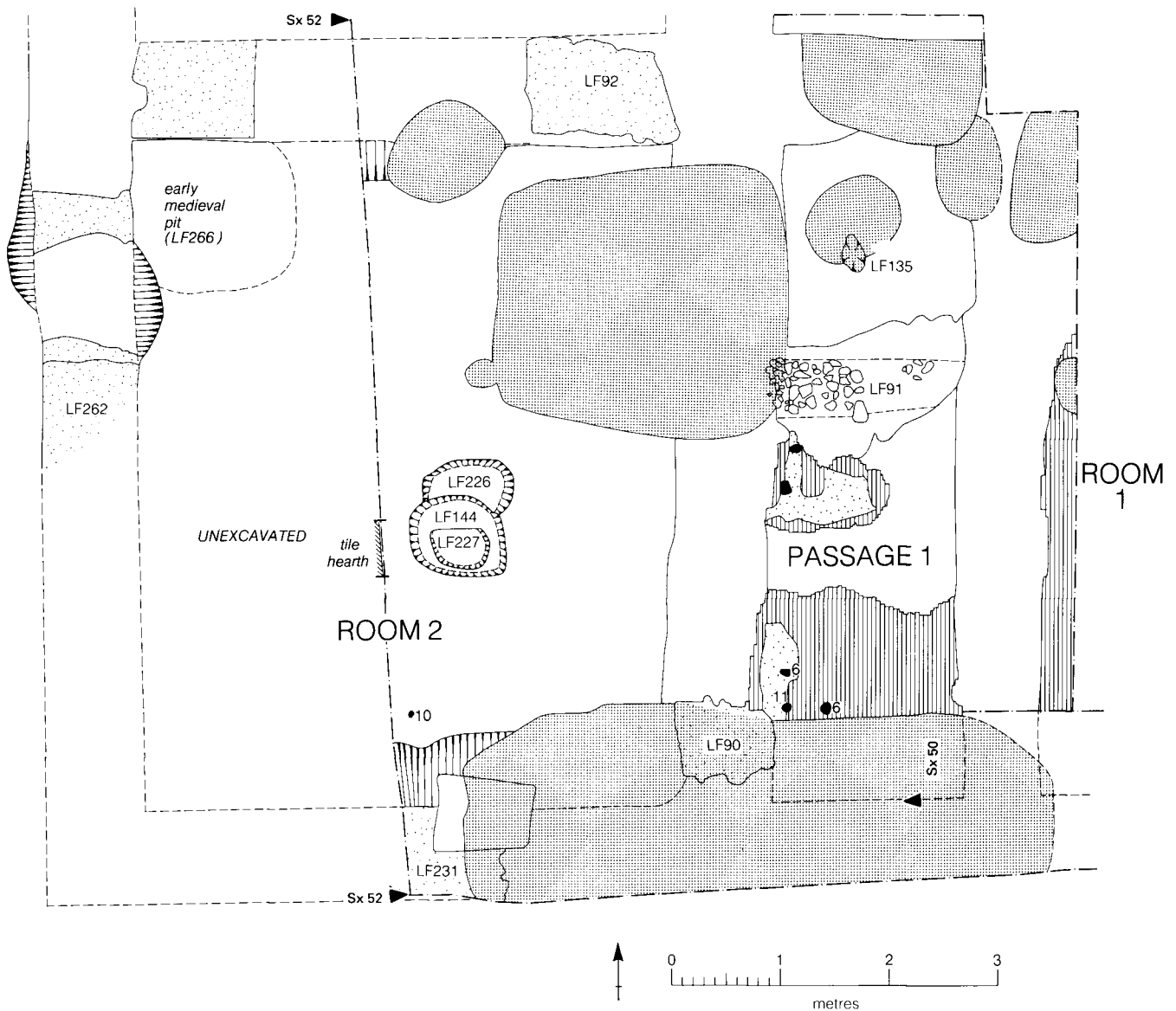


Fig 44 Room 2 (Phase 3) and Passage 1 of Building 19. 1:60. [Page 54]

had not been a hypocaust; it was either tessellated or of daub. The western foundation was of mortared stone because despite being robbed, there was a very thin layer of mortar adhering to the sides of the foundation trench. This was in contrast to the foundation on the north side of the room. This was of septaria bonded in daub. It butted on to the foundation to the west and thus was a later alteration. Room 19 contained a mosaic mostly destroyed by modern services (*see below*). It lay under the modern street surface of Lion Walk and was only partly available for excavation.

Passage 1 (Fig 44) had a tessellated pavement. The foundation LF91 (Sx 50, microfiche) appears to have been a later insertion into the passage. The first floor was of daub with some occupation on top of it. This was followed by a layer of gravel which perhaps was a replacement floor. Later still, the foundation LF91 was built with a tessellated pavement to the south and more daub floors to the north similar to those in the adjacent kitchen (Room 2). The tessellated

pavement sealed a coin of 222 and possibly another of 330-5. This fits the dating evidence of the kitchen. The hearth which just appears at the top of Section 52 through the kitchen is almost level with the tessellated pavement and is thus presumably contemporary with it (*c* 275-300 or later).

Passage 2 was the main corridor around the internal courtyard. It had a tessellated pavement. Passages 3 and 4 were cross-passages. The nature of the floor of Passage 3 is uncertain because the upper levels were destroyed.

Cultivated soil to the north on Site K and to the west on Site Q indicated the presence of a garden (Sx 47, microfiche). No trace of any feature was detected which could be linked with its use.

Building 19 was not systematically demolished but was left to decay. This was proved by a layer of topsoil and broken roof tile which accumulated on the floors, especially in Passage 2. However some daub did lie directly on top of floors (in Rooms 1 and 19) showing

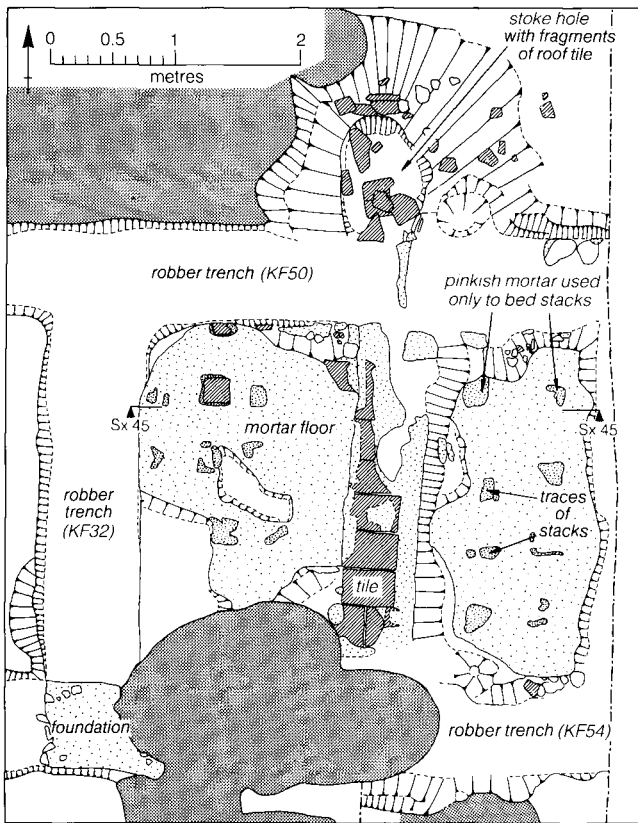


Fig 45 Room 18 of Building 19. 1:60. [Pages 54-7]

that some of the walls may have been demolished or have collapsed shortly after the building was abandoned. An Anglo-Saxon hut (CAR 1, 1-5) was built up against the northernmost foundation and cut the tile-filled stoke hole which served Room 18.

### The mosaic in Room 11/15

by D J Smith

[Plan Fig 46, p58; details Fig 47, p59]

The remains<sup>1</sup> (Figs 46 & 47) have already been well described by Mr Neal<sup>2</sup>, and the reconstructions of its design by himself and by Mr Moyes are of very considerable interest.

It is most regrettable that not more survived but the reconstructions are essentially similar and convincing. Generally speaking, the design — 3.6 m (11ft 10in) in diameter, including the surrounding border — is an important addition to the concentric circular schemes, some with radial divisions, which form a notable category of 4th-century mosaics in Britain (Smith 1969, 104). None of these, however, affords a significant parallel for the mosaic of Lion Walk. It is particularly unfortunate that the remains of the tessellated inscriptions appear to be unintelligible (*Britannia*, 4, 1973, 331, fig 20), but the only relatively well preserved figure was evidently a female whose billowing robe has reasonably been likened by Mr Neal to that of a maenad. But female figures apart from maenads may be depicted in billowing costume, and it seems at least worth recalling the remains of two other mosaics of radial

design with draped female figures in panels which may be relevant to the mosaic of Lion Walk. One, probably datable soon after AD 115, was found in Antioch (Levi 1947, 36-8, pl 5b). The second, recently assigned to c 350-400, was found in Carthage (Hinks 1933, 89, no 89; cf Dunbabin 1978, 251, no D.16, pl 43, 110). In both of these the figures are personifications of the months of the year. At Antioch the figures, identified by captions, occupied twelve juxtaposed panels radiating from the central circle in which had been depicted a large head perhaps portraying Annus (*ibid*, 36, n 6). In the mosaic from Carthage the panels depicting the months were arranged in two concentric zones, eight in the outer zone and four smaller in the inner (Hinks 1933, fig 98); and if less had survived of the four figures which are more or less preserved, one of whom is dancing, it is possible that these might have been tentatively identified as maenads (*ibid*, figs 99-101, pl 29). In short, it seems not altogether inconceivable that the radial mosaic of Lion Walk may have depicted personifications of the months in an arrangement analogous to that of the mosaic of Carthage. Here, too, eight panels were arranged in a zone around a central circle, within which there would have been ample room for four more, not necessarily of the same size or even of the same shape.

There can be no doubt that this mosaic dates from the 4th century, but closer dating is at present impossible.

### Notes

1. I am much indebted to Mr David T-D Clarke, Curator of the Colchester and Essex Museum, for inviting me to see the remains of this mosaic *in situ*, and to Mr Philip Crummy, Director of the Colchester Archaeological Trust Ltd, for photographs and colour slides not only of the fragments but also of the reconstruction drawing by Mr R H Moyes. Mr David S Neal has also most kindly presented to me photographs of his own reconstruction drawing and of his paintings of the fragments *in situ*.
2. Neal 1981, no 41. It may perhaps be added, however, that in Britain a border of paired simple guilloche is decidedly more than unusual; and it has recently been noted that the motif of the laurel wreath entwined with a ribbon (or sash) is probably a North African development (Wilson 1982, 414, with references). ■

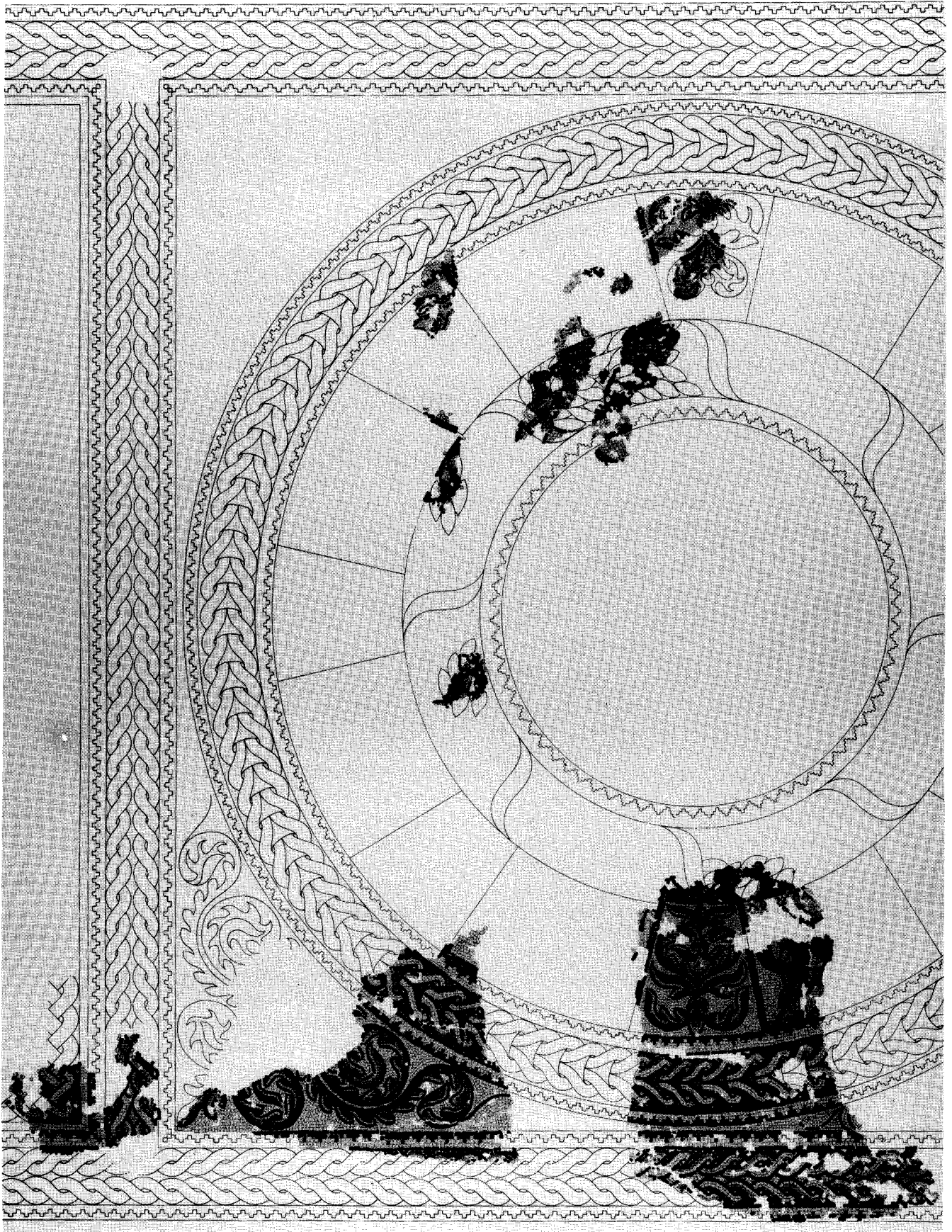
### 'The Mosaic of the Lion' in Room 19

by D J Smith

[Plans & photograph Fig 48, p60, & Fig 49, p61]

The following description is based on a colour slide and black and white photographs, including one of the very carefully executed paintings by Mr R Moyes kindly provided by Mr Philip Crummy. The remains of the mosaic are on display in the Colchester and Essex Museum.

All that has survived is part of one side, but this suffices to indicate that the mosaic had had a design in the form of a saltire and a surrounding border, the whole measuring 3.80 m (12 ft 6 in) square (Figs 48 & 49). There remained part of one arm of the saltire and most of one of the lateral triangular panels.



0 50cm

Fig 46 Painting (by R H Moyes) of mosaic in Room 11/15 of Building 19. [Page 57]



Fig 47 The mosaic in Room 11/15 of Building 19: details (from painting). [Page 57]




Fig 48 Painting (by R H Moyes) of 'The Mosaic of the Lion'. [Pages 57-62]

The border surrounding the design is a band, 225 mm (9 in) wide, of right-angled Z-pattern in red, white and yellowish-brown on a black ground between two bands of inward-pointing stepped triangles in dark brown on a white ground. Bands of the same pattern, but 200 mm (8 in) wide, border the lateral triangular panels (so forming the arms of the saltire), the median right-angled Z-pattern being interlinked at their basal angles with that of the surrounding border. The height of the surviving triangle, including its border and the surrounding border, is 1.13 m (3 ft 9 in). There must therefore have been a central panel, square or circular, measuring with its own borders 1.54 m (5 ft) across.

Inscribed in the surviving triangular panel is a semicircular feature suggesting the two outer flutes on either side of a scallop shell, narrowing towards the apex of the triangle, but with the flutes outlined and shaded as though convex and shaded as if those on the left were lit from the right and *vice versa*. The shading is in dark red, red, and pink, and the outlines are dark brown. Within this is depicted a lion, moving to the spectator's right with its head turned towards the spectator and its left jaw touching the upper edge of a basket of (?) fruit and leaves. Apart from damage involving the loss of the right hind leg the lion was more or less intact. The forepaws and the right hind paw rest on the basal side of the panel, the left forepaw just touching it, but the left hind paw is slightly higher. The tail curls upward. Altogether the suggestion of movement is well conveyed. There is no shadow. Above the animal's back was an indeterminate feature of which insufficient remains to be intelligibly described. It does not appear, however, to have been a tree.

The lion is depicted in grey and shades of olive and brown except for its mouth which is indicated by three pink tesserae in a row, and the strands of its mane which are in black. The basket is depicted in similar tones but the (?) fruit has a pink centre. The remains of the feature above the lion are in dark and light brown. The lion is executed generally in tesserae about 7 mm (0.3 in) square but with triangular tesserae in the neck and mane, and the tesserae of the basket and its contents are slightly larger (9 mm: 0.4 in). The tesserae of the white background, and in the feature above the lion, are up to 10 mm (0.4 in) square or more, but those of the background include many of oblong shape and were laid in surprisingly irregular rows. From the point of view of technique, however, the most striking aspect of this panel is the mosaicist's departure from the traditional and universal practice of surrounding the outlines of

motifs with one or two rows of white tesserae. From this and the irregularity of the background it appears certain that the tesserae were inserted into their bedding mortar by the 'direct method', ie *in situ*, one by one, as opposed to other methods by which mosaics are prefabricated in sections.

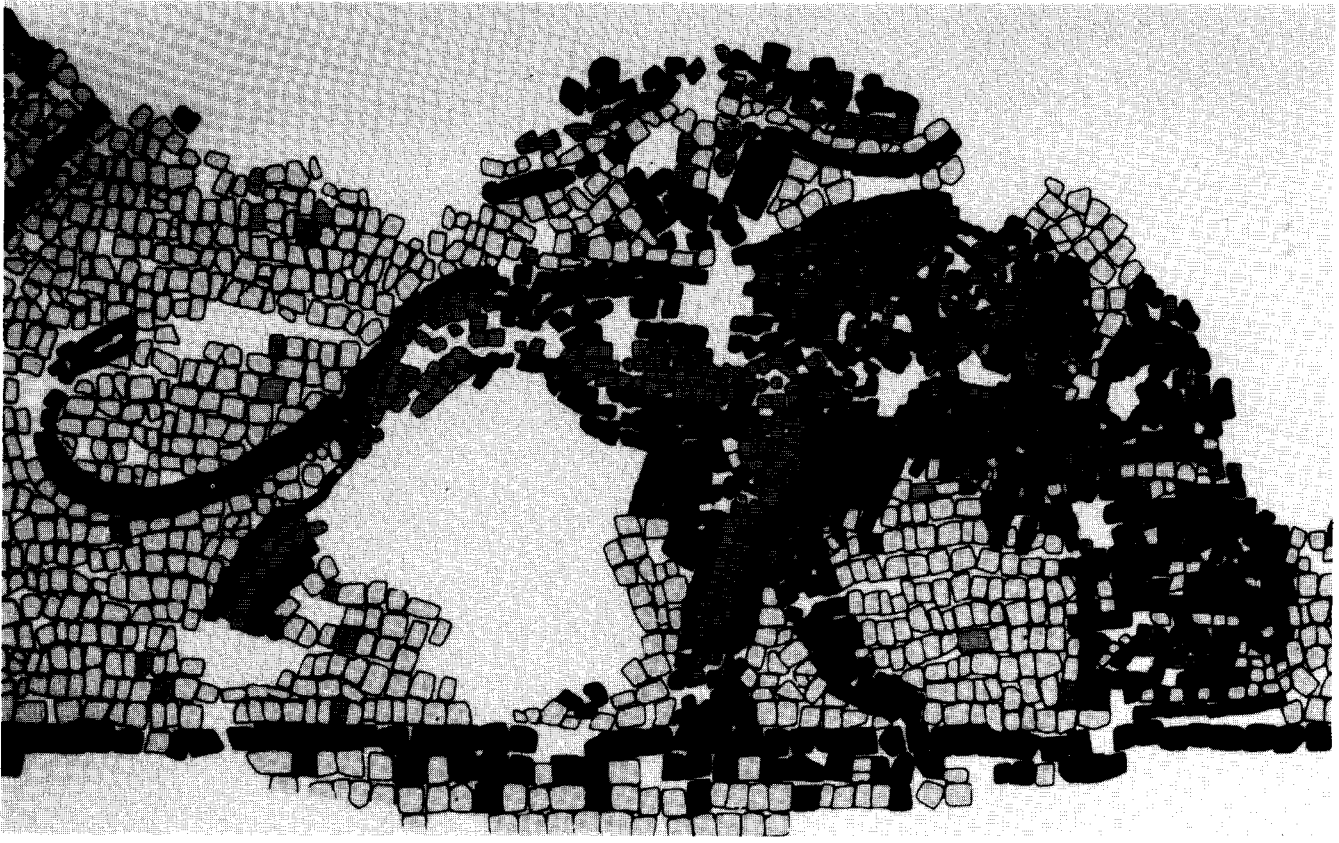
The remains of one arm of the saltire preserve a considerable part of a boldly depicted but conventionalized spray of acanthus. This was executed in red, pink, olive, grey, and white, and outlined in dark brown. The tesserae employed here average a little larger than those in the lion but a little smaller than those in the white background of the lion, while those of the white background of the acanthus, and those forming the borders, are more or less similar in size to those of the white background of the lion.

There was a plain surround of large red tesserae.

Saltire designs form a well defined category of 4th-century mosaics in Britain, most probably produced by a workshop in Corinium, Cirencester (Smith forthcoming), but these are non-figured (with one explicable exception) and characterized by a distinctive repertory of filling-motifs not one of which appears in the remains of the mosaic under discussion. This is certainly not one of these.

It is difficult not to see the semicircular feature framing the lion as a derivation or an adaptation from the motif of the scallop shell, though as such it may well be unique. The lion itself is clearly not from the repertory of scenes of hunting or the amphitheatre, such as that in a well known mosaic of Verulamium (Neal 1981, no 75). Without the accompanying basket of (?) fruit and leaves it recalls two renowned mosaics from Antioch in which a lion is the centrepiece (Levi 1947, 313-5, pl 70, the Mosaic of the Beribboned Lion; *ibid*, 321-2, pl 74, the Mosaic of the Striding Lion) and one from Uzitta in Tunisia, now in the Antiquarium at Carthage (Salomonson 1964, no 39, pl 18). That of Uzitta, assigned to c 200-250, incorporates a tessellated inscription suggesting that the mosaic was commissioned by a certain Leo (or possibly Leontius). The two mosaics of Antioch date from the 5th century (Levi 1947, 626) and in these the choice of motif reflects the influence of the repertory of Persian art on late Roman mosaics in east Mediterranean provinces. In the Colchester mosaic, however, the lion is not the central, dominant motif; and the basket of (?) fruit and leaves associated with it must be taken into account in any attempt to explain the subject here. Such a basket appears in a mosaic of Silchester, Hants (*Archaeologia*, 55, 1896, pl 15), and





*Fig 49 Painting of the lion in 'The Mosaic of the Lion' (above) and the remains in situ (below). [Pages 57-62]*

in mosaics elsewhere. The most magnificent manifestation of this motif is in a mosaic on the rib of one of the vaults in the mausoleum of the Empress Galla Placidia at Ravenna, dating from c 425/430. It is a motif symbolic of bounty, and its association with the lion at Colchester therefore raises the question whether the animal here is to be regarded as a related symbol. In fact, in a number of mosaics a lion appears as a symbol of the season of summer (cf Dunbabin 1978, 110, *n* 8; Smith 1980, 134-5; Lancha 1981, 221-2, no 368, pl 111a). That the contents of the basket are not specifically identifiable as produce traditionally associated with summer, eg corn, is perhaps not significant here: the motif is a symbol of bounty generally. If so, it seems probable that the other lateral panels depicted animals symbolic of the other three seasons, eg a dog or a bull for spring, a leopard, panther, or tiger for autumn, a bear, boar, or stag for winter (cf Dunbabin 1978, *loc cit*; Smith 1980, 135; Lancha 1981, *loc cit*).

In the remains of an arm of the saltire the character of the spray of acanthus has no analogy in Britain except in the other fragmentary mosaic of Lion Walk, which has been assigned to the 4th century (see above). In that mosaic, however, the figures and naturalistic motifs were surrounded by the traditional double row of white tesserae of the background, and its technical standard has been assessed as that of the best laid mosaics in Britain (Neal 1981, no 41). Technically, the Mosaic of the Lion is markedly inferior. Though possibly from the same workshop it cannot be attributed to the same craftsman and appears appreciably later.

It remains only to add that the employment of right-angled Z-pattern where some form of guilloche would normally be expected is noteworthy. Indeed the absence of any form of guilloche in this fragment — admittedly relatively small — is surprising. ■

## Building 20 (Period 4 of Site J)

[LWC Sites J&P; general plan Fig 40; p53; detail plan Fig 42, Sheet 2b; large-scale plans Fig 50, p64 & Fig 51, p65]

Building 20 was a courtyard-house and was reminiscent of Buildings 8 and 16 which preceded it in that its central yard was in almost the same position as the earlier yards. Building 20 was of two phases (Figs 40 & 42), the second being marked by the introduction of mortared foundations, the laying of tessellated pavements in many rooms, and the amalgamation of Rooms 5 and 6 into one.

The foundations of Phase 1 were mainly of packed gravel set in continuous trenches, apparently uninterrupted even for doorways. The upper 0.3 m of one foundation (JF214) contained fragments of tile bedded horizontally. Additional pieces were laid along the top so that the flanges were upright and coincided with the edges of the foundation as if to form a base for a timber ground-plate. Some the walls of Phase 1 were retained in Phase 2. In most cases, these were the internal walls. Stumps of some of them survived *in situ* often with wall plaster still adhering. They seem to have been of solid daub

without any timber-framing although it is not possible to be certain. The east wall of Room 1 was replaced in Phase 2 and to do this a slot, apparently for a ground-plate, was cut into the stump of the Phase 1 wall. The foundation along the street frontage contained some septaria as well as gravel (Sx 33, microfiche). An east-west Phase 1 foundation in the south-west corner of the site was of rubble (Sx 40, microfiche) perhaps indicating alterations within Phase 1.

Four rooms along the street frontage were examined. Two of these were workshops whilst the other two rooms were of better quality. The activity inside the workshops can be divided into two phases. The footway contained a series of fine worn surfaces formed of small gravel with patches of abraded tile and pottery, all lying horizontally. Only the surfaces on the south side of the footway survived, a fact reflecting the areas least exposed to foot traffic. The internal yard had three successive gravel surfaces, none of which showed the wear noted in the footway. The changes in the workshops and the various surfaces in the yard and in the footway cannot be neatly equated with the two main structural phases of the building. However there is a rough correspondence which can be deduced stratigraphically and this is what is presented here.

In the yard were a number of votive deposits broadly equatable to Phases 1 and 2. At first they took the form of very small pits filled with charcoal-rich soil and then in Phase 2 they consisted of small pots buried upright. One of the small pits contained the cremated remains of a small ?animal of indeterminate species. The other pits may also have been dug for cremations although no bones were found in them. This is possibly because the upper parts of the pits had been destroyed as a result of post-Roman erosion. The contents of the pots did not survive. The shallow pits were all in the centre and southern end of the yard and were as follows: JF272 (?animal cremation), JF208, JF212-3, & JF228-31. The pots were JF48, and JF73-4 (Appendix 8, microfiche).

The best and clearest evidence for the starting date of Phase 1 came from the third occupation layer in Room 7 and the first two surfaces in the yard. All point to an Antonine date for the construction of the building. A date c 150 is assumed but possibly the house may have been built a little later.

Quite clearly the building had been demolished and not left to decay. The latest floors were covered with a layer of daub and crushed wall plaster left after the demolition of the building (eg Sxs 34 & 40, microfiche). The debris contained several coins of late 3rd-century date and thus is consistent with the evidence from the occupation on the floors where there was nothing after c 275. The building is taken to have been demolished c 300 although in total the evidence is limited. Rooms with paved floors contained no late finds because, unlike daub floors, these could be kept clean. Also the latest surfaces of the workshops, the yard and the footway were lost because of erosion. Moreover, in Room 1 the demolition debris was thinner than elsewhere and

slightly discoloured; it contained a coin of 341-6 and possibly related to Period 5.

Each of the tessellated pavements was laid on a base of lumps of greensand. In Room 9, the pavement had been repaired with two patches of plain mortar. In places, the demolition debris directly overlay the mortar bed of the pavement suggesting that, as at Middleborough (p166), some of the cubes had been scraped up during the demolition for reuse elsewhere.

The foundation along the north side of the footway was made of unmortared septaria lumps. It was substantial and sufficiently deep to reach the natural. It could not be established if, when the foundation was built, a gravel-packed foundation of Phase 1 was removed. This was certainly the case with the foundation of the frontage wall where pockets of the Phase 1 foundation survived at the base of the robber trench for the mortared foundation of Phase 2. Where other gravel-packed foundations were replaced, the Phase 1 foundations were not dug out but the tops of them were exposed to form bases for the new foundations (Sxs 31 & 40, microfiche). The Phase 2 foundation of the south wall of Room 1 (JF182) also extended down to the natural and there was no trace of a gravel-packed predecessor. A small part of the foundation between Rooms 2 and 3 had not been robbed; this was greensand and mortar. Enough of the foundation in HF2 survived to show that this had been of septaria and mortar.

Along the west side of the yard was a timber-lined drain. It existed in Phase 2 but whether it belonged to Phase 1 was not clear.

Not much of Room 1 in Phase 1 was seen but it had a daub floor and plastered daub walls at least on the east side of the room where the stump of the wall survived (Sx 34, microfiche). In Phase 2, a tessellated pavement was laid and a slab of reused Purbeck Marble was incorporated in it to form a threshold. The frontage wall was rebuilt with mortared stone foundations which, unlike the gravel-filled foundation which it replaced, was interrupted in the middle of the north side of the room to form a wide doorway at least 2.5m across. Also in Phase 2, the east wall was rebuilt; a tiny piece of its wall plaster survived *in situ* at the south end.

The walls of Rooms 2 and 3 were not plastered. During Phase 1 (Fig 50), many pits were dug inside these rooms. Some were well over a metre deep and many had been dug hard up against the walls (JF184, JF365, JF366, JF404, JF458, JF462, JF464, JF466 (probably), JF494/499, JF496, & JF576). Several of the pits were long and narrow (JF497, JF507, & JF587) or had a slot at the bottom (JF184, JF576, & JF494/499). The sides and bottoms of many of these pits were stained green (JF184, JF365, JF462, JF464, JF465, JF494/499, & JF587). A sample of green-stained soil was examined without success to try to establish the cause of the discolouration (Appendix 9, microfiche). The purpose of the pits is obscure but they may have been cess-pits in which case Rooms 2 and 3 seem to have served as a lavatory

in Phase 1. The pits could not have been open very long because they were backfilled with their own excavated material. This was shown by the presence in the fill of large lumps of redeposited daub floor much of which still had streaks of occupation adhering. Also in Room 2 were some burnt patches of daub which seemed to be the bottoms of hearths. They were not related to the hearths of Phase 2 since these were in different positions.

In Phase 2 (Fig 51), Rooms 2 and 3 had no pits. The floor of Room 2 had been extensively burnt to varying degrees and contained two structures with bases made from reused tegulae. These were possibly the remains of hearths (p25). Also a storage jar (now broken) had been set upright in a pit (JF304; Appendix 8, microfiche). In Room 3 a burnt patch similar to those in Room 2 suggested that there had been a hearth or other such feature in the room.

Between Rooms 2 and 3, certainly in Phase 2 if not before, was a wide doorway at least 1.8m across. Its position is shown by the south end of the Phase 2 foundation trench. The south jamb of the doorway (assuming that the gap contained a door) was flush with the north face of the east-west wall which forms the south side of Rooms 1 to 4. The bottom of this face survived as a stump indicating that there must also have been a doorway in this position in Phase 1 since the wall itself was of Phase 1 origin. The Phase 1 wall plaster which survived for nearly all of the length of the east wall of Room 1 appears to have left almost no room for a doorway between Rooms 1 and 2. The only gap was at the south end where the latest levels were destroyed by a later pit. If there had been a door here then it was at most only 0.5 m wide. This is surely too narrow and thus probably these rooms could not be entered directly from Room 1. The same was probably true of Rooms 3 and 4 where most of the base of the daub wall which separated the two survived (although traces of a doorway may have been destroyed when a large pit was dug in the central part of this wall). The fact that the frontage wall of Phase 2 on the north side of Rooms 2 and 3 was unbroken suggests that there were no doorways between these rooms and the street unless the breaks which did occur elsewhere in the Phase 2 foundations were only where the doorways had been exceptionally wide. Probably Room 2 was entered from the southwest from Room 6 where the absence of a daub wall is either significant in this respect or else merely the result of post-Roman destruction.

The only part of Room 4 to be excavated was its west wall where painted wall plaster was *in situ* at the north end. Although plastered, there was no trace of a tessellated pavement. Little is known about Rooms 5 and 6 in Phase 1 except that they had daub floors and that Room 6 contained two small pits (JF232 & JF302). The two rooms were combined in Phase 2 and a tessellated pavement was laid. Room 7 had daub floors in both phases. In Phase 1, the room contained stake holes and then in Phase 2 a tile hearth was built against the north wall (Fig 51). Only a very small part of Room 8 was examined. It had a daub floor in both phases. In Phase 1, Room 9 contained an



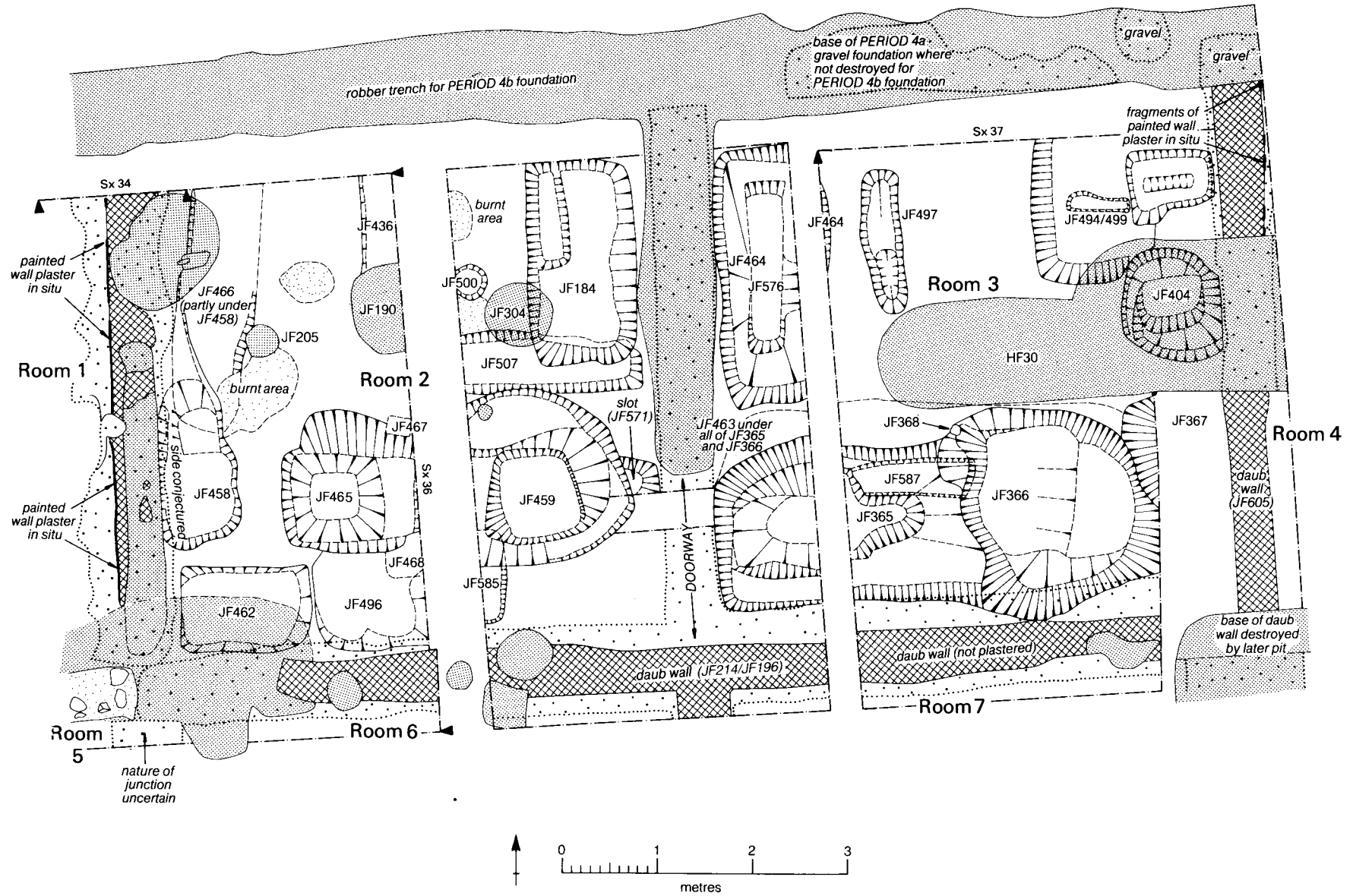


Fig 50 Building 20, Phase 1, rooms along the street frontage. 1:60. [Page 63]

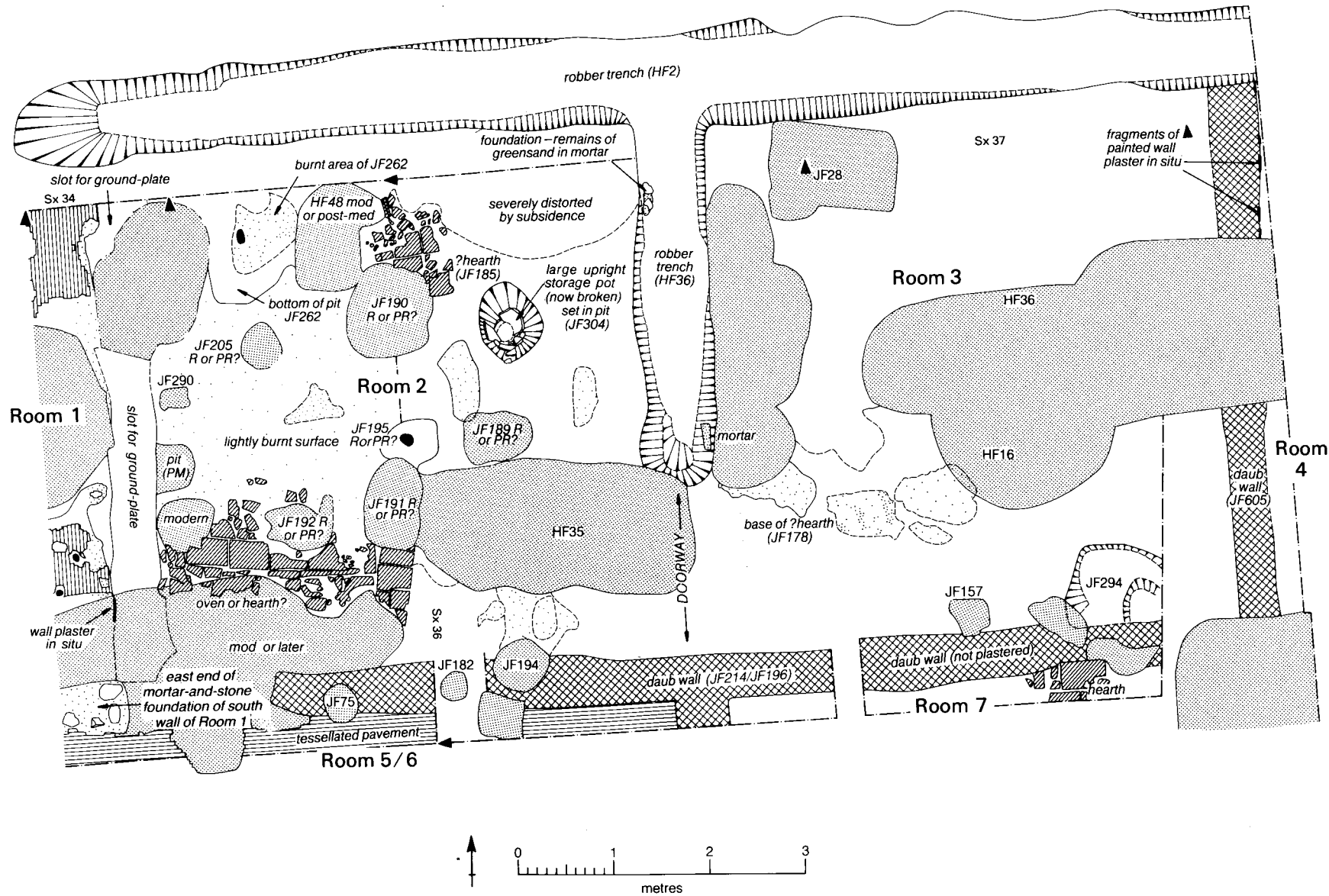


Fig 51 Building 20, Phase 2, rooms along the street frontage. 1:60. [Page 63]

oven (JF226) which had a small notch on each side. The scorching around the edge of the oven continued around the notches. In Phase 1, the floor of the room was gravel which in Phase 2 was replaced by a tessellated pavement. The sequence of floors in Room 10 was similar.

On Site P, the latest floors and foundations of Rooms 11 to 16 were exposed, cleaned, and planned without any substantial excavation. Later they were trenched by machine. Rooms 11, 15, and 16 had tessellated pavements; the others seemed to be of daub including Room 12 which was the largest room found in the house. Presumably, as elsewhere in the house, the tessellated pavements replaced earlier daub floors.

Passage 1 had a daub floor laid over gravel. In Phase 2 this was replaced by a tessellated pavement. Passage 2 was a small cross passage between Rooms 10 and 11. First it had a daub floor with no underlying gravel and then in Phase 2 a tessellated pavement was laid.

A timber-lined drain (JF180) lay alongside the south edge of the street. This certainly belonged to Phase 2 and may perhaps have been built in Phase 1. Sometime during the course of Phase 2, a large pit (EF61) 2.0 m deep was dug in the middle of the street.

In addition to the group of votive pots found in the central yard and mentioned above, there were also two others which were not planned but were found during section drawing: one (JF422) in the east section of Room 3 and JF82 from the north-west corner of Site J.

## Building 21 (Roman)

[LWC Site D/G; general plan Fig 40, p53; detail plan Fig 42, Sheet 2b]

Only the latest Roman levels were examined on Site D/G (Figs 40 & 42). These were difficult to interpret in terms of plan except that there was a footway and several rooms. Two of the rooms had tessellated pavements and the others seem to have had daub floors. All the foundations were mortared. Some demolished daub wall was found on top of a tessellated pavement. It contained a little 2nd-3rd century pottery and showed that the building had been demolished rather than abandoned.

## Building 22 (Period 5 of Site B)

[LWC Sites B and S; general plan Fig 40, p53; detail plan Fig 41, Sheet 1a; large-scale plans Fig 52, p67, & Fig 53, p68]

The principal part examined of Building 22 (Figs 40 & 41) was the cellar BF70 on Site B. The building continued northwards into Site S where a foundation and some robber trenches were exposed and planned but could not be excavated.

The cellar was situated on the street frontage and was of two phases (Fig 52). The first consisted of a burnt timber floor sealing a series of pits. One of the pits (BF248) contained the bones of at least two babies (Appendix 1). The other pits may have been dug to take scaffold poles. The burnt floor was cut by two more pits which thus post-dated the fire. Then

followed a mortar floor (Phase 2) which in turn was cut by pits for three votive pots (BF128-30; Appendix 8, microfiche) placed along the side of the south wall. The western pot contained the bones of three puppies.

The outer faces of the cellar walls on the west and south sides were close to the natural sand into which the cellar was set. However on the east side, there was a wide construction trench. A passage was formed in the eastern part of the cellar when a short north-south wall was built. This wall was not an original feature because it butted on to the north wall of the cellar and was of a different construction to the others. The latter were built of tile and septaria laid in alternating courses over a foundation which consisted of a single tile course 0.15 m wider than the walls (Fig 53). The later partition wall was mainly of coursed septaria and had a shallow foundation of mortar and stone which shows clearly in Section 3 (microfiche).

The relationship between the burnt floor and the outer walls of the cellar is not clear; it is possible that they could have been contemporary and that the mortar floor was a later addition. No trace of the Phase 1 deposits occurred under the mortar floor in the passage. Perhaps the stone walls of the cellar were not original but were an enlargement of what was there before or perhaps the deposits had been shallower in this area of the cellar and were destroyed when the mortar floor was laid?

The east and west walls of the cellar lined up with two foundations (BF117 & BF126) of Building 23 to the south thus giving the impression of a unified plan and therefore one building. However the foundation BF117 should in any case line up with the front of the cellar since both lie on the street frontage and the alignment of the foundation BF126 with the west wall of the cellar is possibly a coincidence. If these were separate buildings as supposed here, the absence of an east-west return between BF117 and BF126 is explicable if the south wall of the cellar was a party-wall (p25).

In the backfill of the cellar was a large section of a collapsed wall (Fig 53). It was 0.4 m wide and was made of septaria and tile coursed in alternating groups of four and two respectively. Its dimensions were such that above ground level at least one of the cellar walls (probably the southern one) must have been not of daub but of stone and tile. Also it contained a long narrow void where there had been a vertical stud showing that the wall had incorporated some timber-framing. However to judge by the surviving fragment of wall, there could not have been much of it. Also in the rubble was part of a slightly arched lintel for a door or a window. The lintel was made of the type of tile found in *pilae* (Appendix 5, microfiche); the curvature was obtained in the mortar joints, these being thicker to the top.

The principal dating evidence for the cellar consists of a few sherds of Flavian samian below the burnt floor, 2nd-century samian (some Antonine) associated with the floor itself, and in the cellar backfill, ten well stratified coins the latest of which was minted in 330-

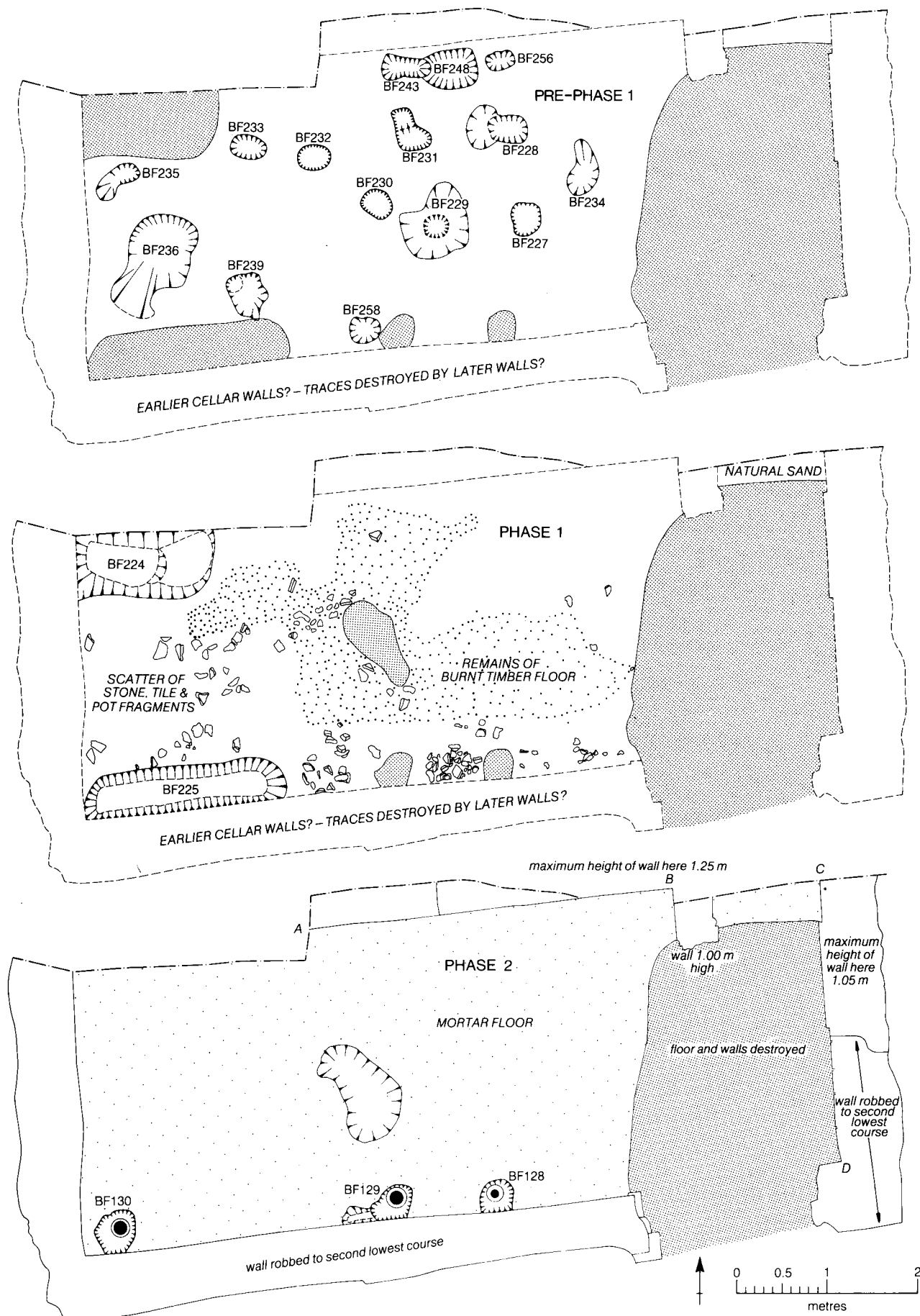


Fig 52 The cellar in Building 22: features under the timber floor (above), burnt timber floor (centre), mortar floor and later features (below). [Pages 66-8]

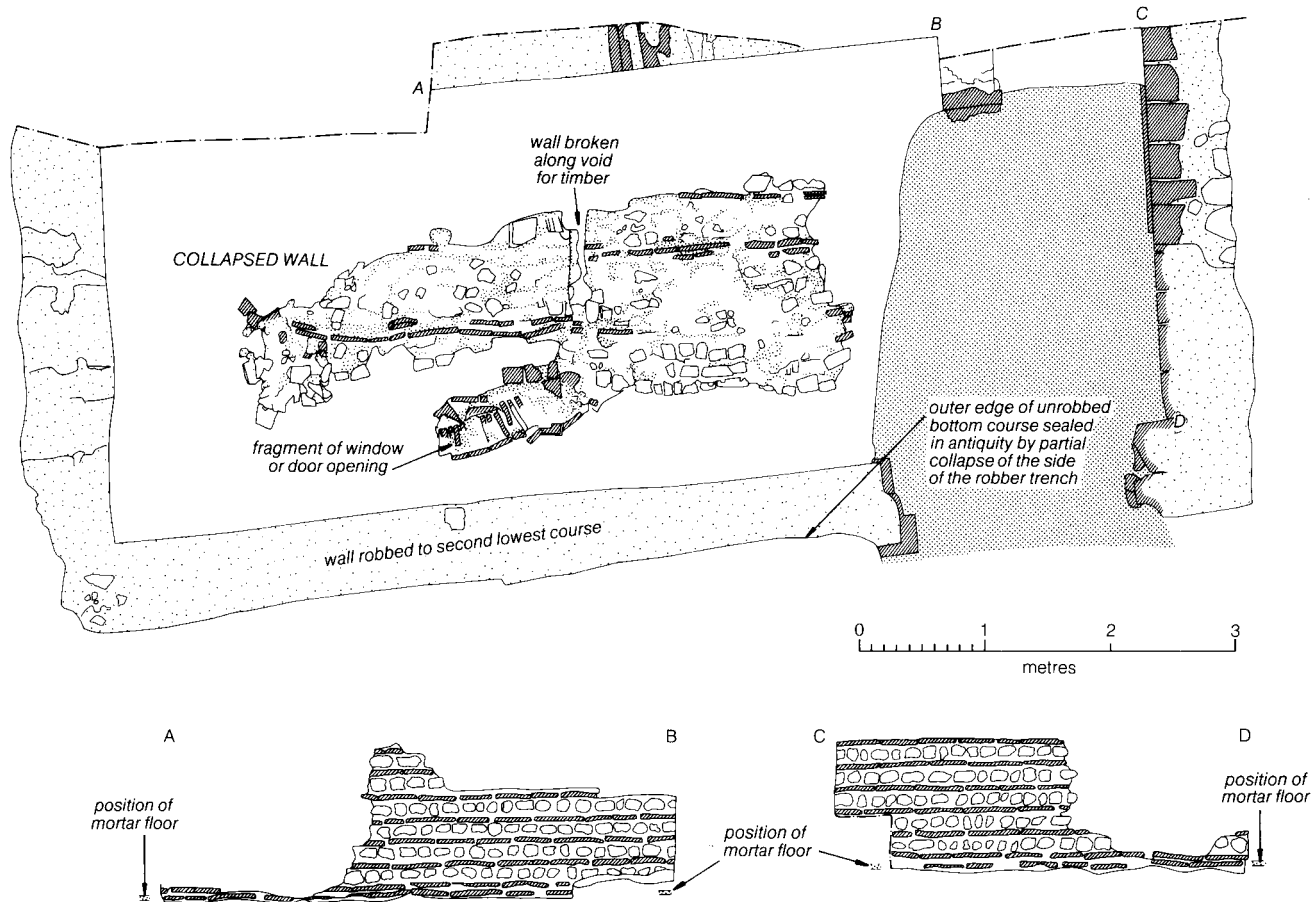


Fig 53 The collapsed wall in cellar in Building 22 (above); two elevations of the surviving cellar wall (below). 1:60. [Pages 66-8]

5. Thus the timber and mortar floors can be regarded as being of 2nd- and 3rd-century origin respectively and the demolition of the cellar and with it the rest of the building as having taken place sometime after *c* 330. The absence of late pottery especially shelly wares in the fill of the cellar suggests that the demolition is unlikely to post-date *c* 350.

### Building 23 (Period 5 of Site B)

[LWC Site B; general plan Fig 40, p53; detail plan Fig 41, Sheet 1a; large-scale plan of pits associated with building Fig 54, p69]

At Building 23 (Figs 40 & 41), the sequence of structural changes was complicated and the following account is probably too simple.

The foundations BF67, BF113, BF117, BF126, and BF136 had not been built in the same manner and hence several structural phases were suggested. Foundations BF126 and BF136 were similar and consisted of small fragments of stone set in daub. Foundations BF113 and BF117 were made of small stones and soil whereas the foundation (BF67) along the street frontage was mortared. This is reminiscent of the situation at Buildings 54-8 at Balkerne Lane where the most substantial foundations were on the street frontage. At the rear of Site B was a layer of gravel which, from the finds associated with it, belonged to Period 5 and thus must have been contemporary with Building 23 if not part of it. The

gravel sealed pits and dump material of Period 4. Foundations BF136 and BF126 sealed the gravel and therefore must have been built late in Period 5. Perhaps these were replacements for walls which had no foundations and which had been built at the same time as the foundation BF67 on the frontage?

In plan Building 23 took the form of a room (BF113 & BF126) flanked on each side by a narrow room or a passage of standard width (BF117 & BF136). There were slight traces of an east-west partition between BF113 and BF117. To the east was a footway formed by BF67 and BF117. This was probably covered. The foundation BF67 seemed to be of two parts in which the section south of the post-Roman pit BF30 contained a substantial quantity of crushed *opus signinum*. The division between the two parts corresponded to the boundary between Buildings 22 and 23. Thus it provided further evidence that Site B spanned parts of two adjacent properties and that, as at Balkerne Lane (p28), there had been some degree of private control of the public footways.

Contemporary with Building 23 were many pits (Fig 54). Of note were three pear-shaped pits (BF163, BF164, & BF147) which were stained green and thus may have been cess-pits. Also green were pits BF165 and BF148. A floor had been laid down sometime after the pit BF147 was backfilled. The floor was later burnt and only survived as settlement in the top of

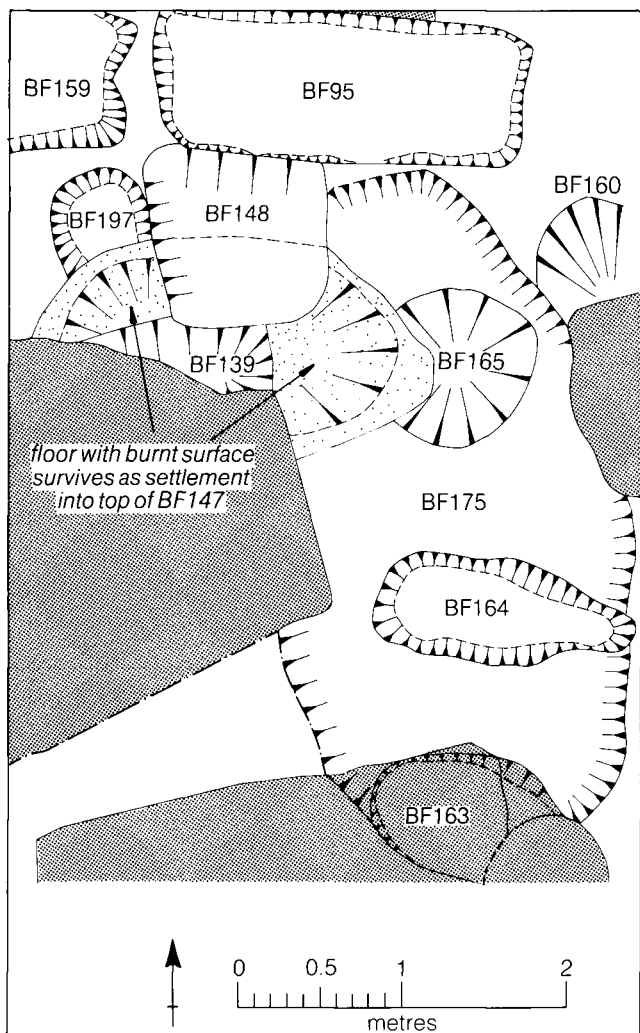


Fig 54 The pits associated with Building 23. [Pages 68-9]

BF147. The pits were apparently dug inside Building 22 although there are some which appear to have post-dated it (BF105, BF107, & BF116). They are possibly late Roman or post-Roman. Feature BF127 is a slot of unknown purpose which appears in Section 8 (microfiche).

The demolition of Building 23 cannot be closely dated but a dearth of late material from the site suggests that the building may have been knocked down in the 2nd or 3rd century. Also the absence of coins minted later than *c* 260 suggests that the demolition took place before the late 3rd century.

A ditch (BF23) which had been dug along the side of the street remained open after the demolition of the cellar BF70 of Building 22.

### Buildings 24 and 25 (Period 4 of Site A/R)

[LWC Site A/R; general plan Fig 40, p53; detail plan Fig 41, Sheet 1a]

The latest levels of Site A/R were only superficially examined and considerable difficulty was experienced disentangling the building plan. The position of the footway was clear and so was the main range of rooms which lay along the street frontage

(Rooms 1, 2, 7, & 8). To the rear of these were at least two passages or rows of narrow rooms (Passages 1 & 3) and two open areas which had been yards. The presence of the yards points to at least two houses but the limits of these are not clear. Tentatively Building 24 seems to have contained Rooms 1, 2, and 3 plus Passage 1 and a yard. And in Building 25, there seem to have been Rooms 4, 5, 6, 7, and 8 plus Passages 2 and 3 and a yard. Buildings 24 and 25 continued beyond the limits of the excavation and it is possible that Building 25 may have extended to the frontage of the north-south street to the west.

In Building 24, Rooms 1 and 2 had tessellated pavements. These were only revealed as a result of machine trenching. The west limit of Room 2 was obscure. Passage 1, the west end of which was also not clear, contained a tessellated pavement. Room 3 had a tessellated pavement which had been damaged in use (many cubes dislodged) and had been repaired in antiquity with patches of plain mortar. Along the north side of Room 3 was a flue made of box tile (Appendix 5, microfiche) but there was no sign anywhere of a stoke hole or a hypocaust. Although shown exposed on Figure 41, the flue was sealed by the pavement.

Three structural phases were detected within Building 25. At first Room 8 had a plain mortar floor whilst that of Room 7 was of sand with occupation containing much charcoal. In Phase 2, tessellated pavements were laid in several of the rooms (Rooms 4, & 8, & Passages 2 & 3) and the west wall of Room 8 was rebuilt. In Phase 3, the west wall of Room 8 was again replaced and probably during this phase the tessellated pavements were repaired because, like the pavement in Room 3, many of the cubes had been dislodged. Room 7 was a workshop and in keeping with workshops elsewhere, was sited on the street frontage. It contained four patches of burnt daub (perhaps the bases of hearths?), several patches of charcoal (including RF49 which was cut by the Phase 2 slot RF5/6), and two small furnaces or ovens (RF43 & RF44) which were similar to JF569 (p36). A small quantity of tap slag was found in the floor of Room 7 but not enough to indicate the presence of iron-making. The workshop was in operation throughout Phases 1 and 2 and probably Phase 3 too although no floor levels of this phase survived. A foundation (RF107) of Building 25 incorporated wooden piles and was probably a later insertion.

There were several odd parts of foundations around the yards. It is difficult to make much of these in plan. Some were only exposed because they had been badly damaged by later pit-digging. Patches (300 x 20 & 80 x 60 mm) of small grey tesserae pointed to small mosaics in Room 3 and Passage 2.

### Building 26 (Roman)

[LWC general plan Fig 40, p53; detail plan Fig 41, Sheet 1a; Sx 61, Sheet 6a]

Building 26 (Figs 40 & 41) is known only as a robber trench in Section 61. Its floors were destroyed by later

activity. The width of the robber (0.8 m) indicates that it probably had been part of a house rather than a public building.

### Building 27 (Roman)

[LWC general plan Fig 40, p53; detail plan Fig 41, Sheet 1a; Sxs 58 & 61, Sheet 6a]

The only remains of Building 27 uncovered at Lion Walk took the form of two robber trenches, one at the north end of Site A/R (RF47; Sx 58, Fig 41) and the other in Section 61 where it appeared along the east frontage of the north-south Roman street (Figs 40 & 41). The width of the robber trench in Section 61 (1.1m) points to a public rather than a private building. Later features and the circumstances of Section 61 did not permit observation of any of its floors. Building 27 is almost certainly the same as the public building partly excavated by Hull on the St Nicholas Church site in 1955 (Hull 1960). If so, then it must have occupied the whole of *Insula* 29.

### End of the Roman buildings

[Photograph Fig 55, p70]

Buildings 19, 24 and 25 were not systematically demolished but were left to become derelict. This was shown by the broken roof tile and topsoil which accumulated on their floors (Fig 55) and contrasts with the layers of daub and wall plaster on the floors of Buildings 20, 21, and 22 (cellar) which show demolition. The dating evidence (where adequate) for deliberate demolition indicates that this occurred well within the Roman period, namely Building 20 down c 300 and Building 22 down c 350. The buildings which were abandoned appear to have the later terminal dates. The latest coins in the soil on the floors of Buildings 24 and 25 were 343-8, 350-3, 350-60, and 364-78. (There is the possibility that some or all of these could be in contexts disturbed by medieval robbing.) No coins were found on or just



Fig 55 The layer of topsoil and broken roof tiles overlying floor of Passage 1 in Building 24. [Page 70]

above the floors of Building 19. The absence of any complete tile in the topsoil over these floors seems to indicate robbing in the late Roman or early Anglo-Saxon period.

Pockets of 4th-century coins were found on the west side of Site J and some sherds of late Roman shelly ware were recovered from a deposit sealing demolition debris of Building 20. The debris survived as settlement into the earlier pit (JF495, Fig 17) just south of HF2. The late coins and pottery point to activity in this area after the demolition of Building 20 but before the Anglo-Saxon hut (Hut 2, p73). The stake holes around the site of the hut (Fig 42) may have belonged to this period but otherwise no contemporary structures were recognised apart from perhaps a patch of tile and gravel which sealed demolished remains of Building 20. Many of the late coins were found in a layer of ?make-up for the house which stood next to the west side of Building 20.

### Roman Town Defences

[LWC Sites M & N; general plan Fig 40, p53; detail plan Fig 42, Sheet 2b; large-scale phase plans and flow diagram for trench across rampart Fig 56, p71, & Fig 57, p72, resp; Sxs 54/62/55, Sheet 6a]

At Lion Walk, a complete section was obtained across the town defences. Sites M and N were dug to either side of the town wall. The wall was subsequently breached by the contractors to make the access into the new service basement. The sectioned wall was drawn and the result combined with the sections from Sites M and N to form the composite Section 54/62/55 across the defences.

Site M (Fig 56) was a trench across the rampart and the underlying layers behind the wall. The sequence is summarized as a flow diagram in Figure 57. The earliest features consisted of a series of small holes and pits. These appeared to be animal or root holes and are not illustrated here. The first clearly man-made feature was a thin but good gravel surface (Street 1) with a ditch or deep slot (MF70) along its south side. Over this was a thick deposit of sand which, mostly at the north end, contained large lumps of septaria. The sand is best interpreted as the levelled remains of the Period 3/4 rampart which the town wall appears to have replaced (pp 11-14). Over the layer of sand was a second street surface. This was of good quality and was mixed with mortar. The surface was level with the top of the foundation of the wall and had clearly been the construction level for the wall. The fact that the lumps of unused septaria were sealed by this construction level indicates that the stone must have been associated with the building of another stretch of wall further along the circuit. Presumably the septaria was the residue of a stock-pile for this earlier stage. That there were no substantial deposits under Street 1, despite this having been laid out over the site of Building 1, showed that the earliest levels had been stripped off before Street 1 was set out. The latter must have been built specifically as a construction road for the wall because it was so thin (and thus presumably

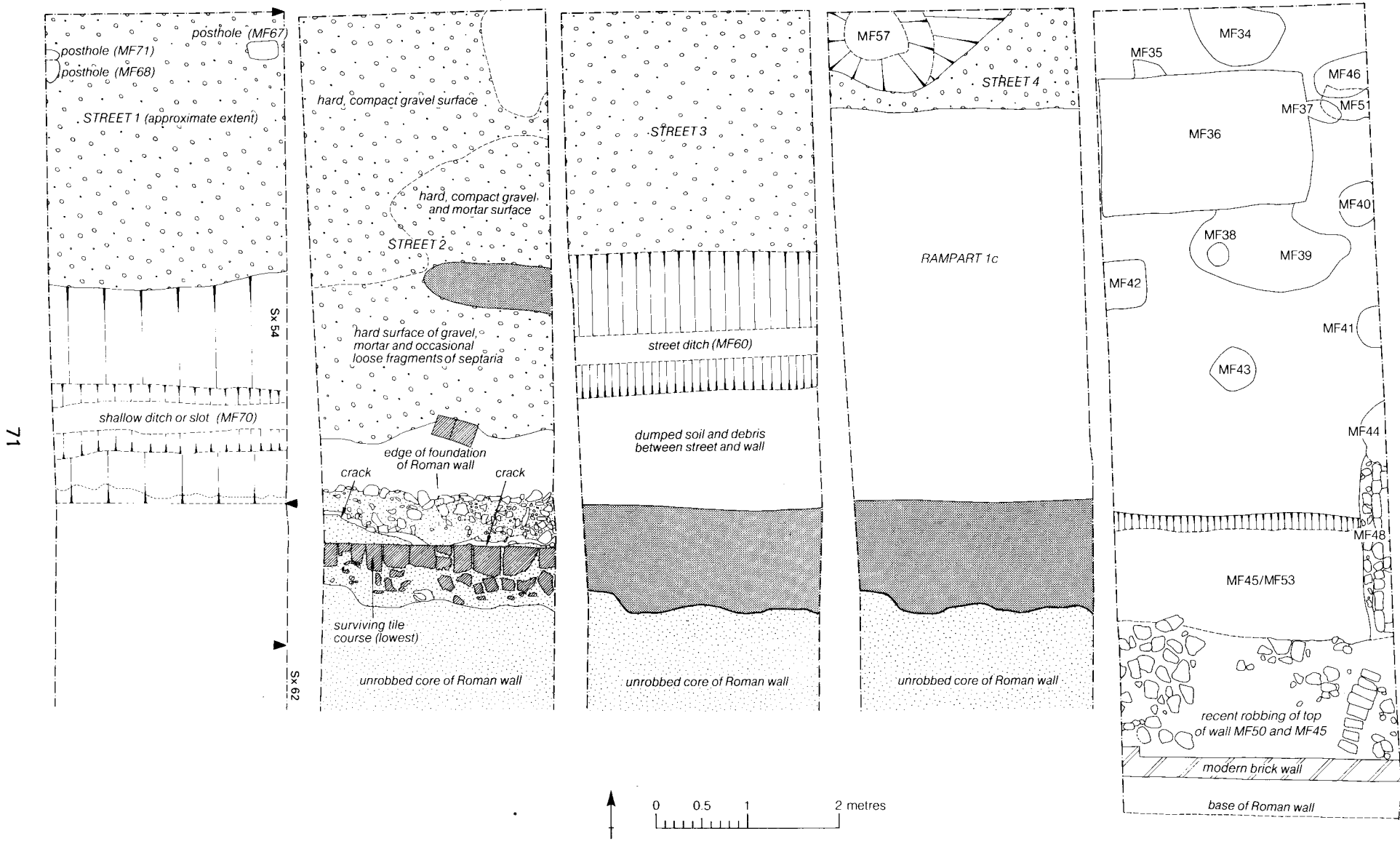


Fig 56 The phases in the trench behind the town wall (Lion Walk, Site M), Earliest to the left. 1:60. [Pages 70-3]



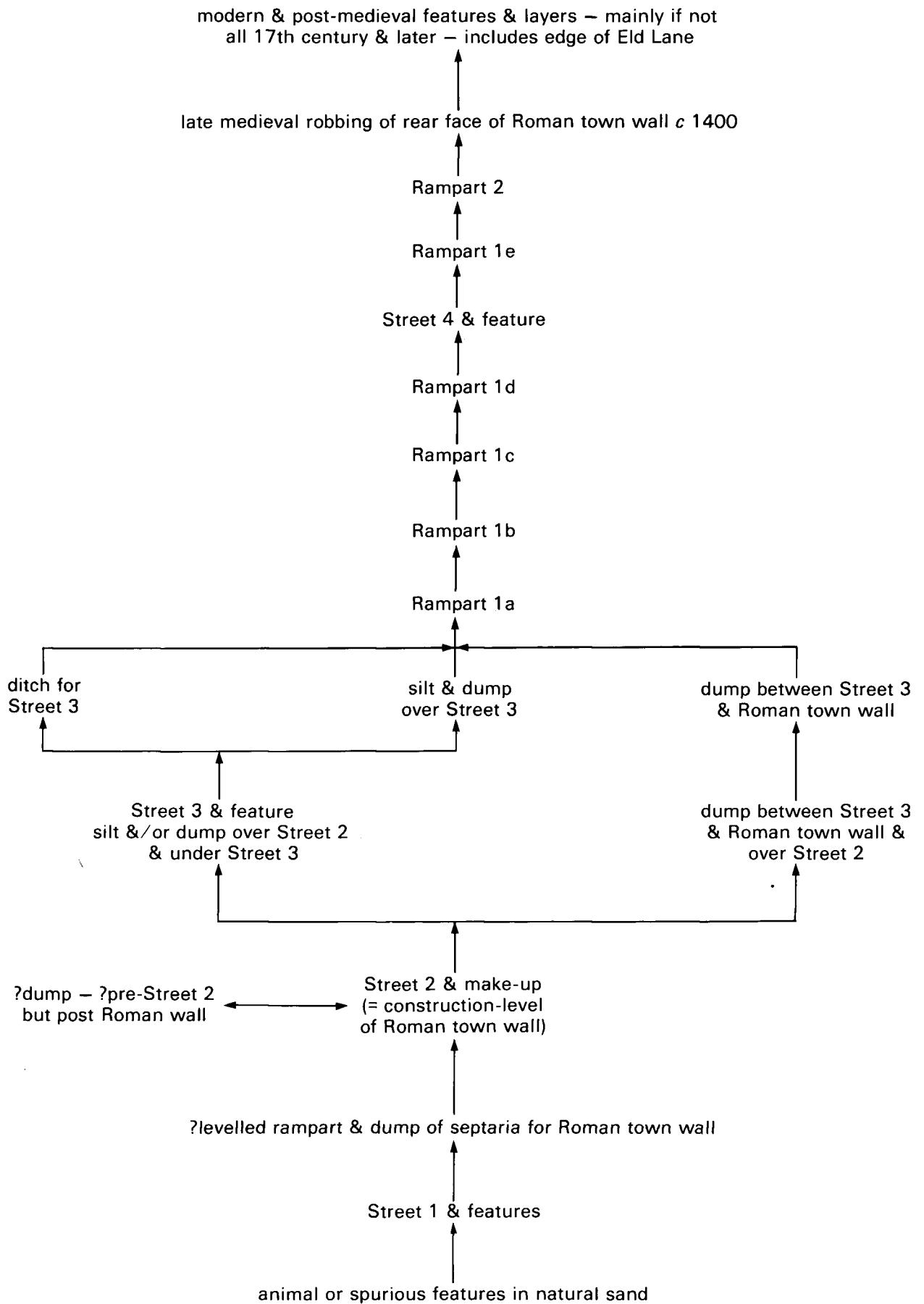


Fig 57 Flow diagram of phases in the trench behind the town wall (Lion Walk, Site M). [Pages 70-3]

temporary) and because it was directly overlaid by the stock-pile. Street 1 was probably laid out around the complete circuit except where there was already a suitably placed street such as on the west side (pp110-1). The sand which contained the lumps of septaria is unlikely to have been spoil from the construction trench of the wall since the foundation of the wall cut into the sand and barely penetrated the base of it. The construction of the wall followed the normal building practice where foundations were made deep enough to reach the top of the natural sand (p20). Great confidence is shown in this technique by the fact that the foundation only penetrated 0.4 m of the material below the level of the sand and septaria.

After the wall was completed, the street behind it remained in general use and the wall was free-standing without a rampart. Some silting and dumping of household refuse occurred along the street until it was resurfaced (Street 3) and a ditch dug between it and the wall. Silting and dumping then resumed until work began on the building of the rampart.

The material used for the rampart was almost entirely daub from demolished walls and came from building sites in the colony. It contained a little household debris. There were two periods of rampart, the first of which was built in stages. Five of these were detected in the trench at Site M (Phases 1a-e). The main phases of the Period 1 rampart seemed to have been built up as a series of substantial tips. These were discernible during the excavation and each seemed to correspond to a cart-load of debris dumped on to the rampart from the east side. Between Phases 1d and 1e, a new street was laid (Street 4). Phase 1b of the rampart was comparatively slight and contained mainly household debris. It was perhaps not a proper stage of the rampart but was the result of some localised dumping indicative of a hiatus between Phases 1a and 1c. The material to build the second period rampart was identical to that of Period 1, the only difference being that this contained some later pottery of c 250-350 (Appendix 10, microfiche). Perhaps the Period 2 work was a heightening of the rampart which accompanied a similar heightening of the town wall. Very little of Rampart 2 was excavated.

The most useful dating evidence can be summarised as follows (Appendix 10, microfiche). The latest sherd sealed by the construction level was in the septaria and sand dump where there was a sherd of *terra sigillata* of c 65-80. In the silt and dump over Street 2 and under Street 3 there was some Flavian and early 2nd-century material. Street 2 contained some 2nd-century pottery. The dump over Street 2 and between Street 2 and the town wall contained a coin of 103-112 as well as some early 2nd-century sherds. The dump between Street 3 and the town wall produced late 1st to early 2nd century pottery. The ditch to the south of Street 3 contained sherds of mid 2nd century date. Antonine pottery was plentiful in all phases of Rampart 1. Also Rampart 1 Phase e contained a coin of 98-117. Rampart 2 yielded sherds which date from the mid 3rd to the mid 4th centuries.

The remains and the structure of the town wall have already been described (p14). A wide, east-west ditch was found on Site N, to the south of the wall. Its original dimensions could not be established. The north edge had been destroyed by an 11th-century ditch and there had been so much erosion at the foot of the wall not only here but elsewhere (p15) that it is impossible to reconstruct the original ground level with much certainty. However the ditch must have been about twenty metres wide and between three and six metres deep. Clearly it had been similar in context and dimensions to the Period 5/6 ditch at Balcerne Lane (p145). No trace was found of an earlier ditch at Site N.

## Roman streets

In the immediate post-Boudican period the streets often contained make-up formed of Boudican destruction debris. Characteristically the daub is well mixed and hence must have been redeposited several times since the fire. A major raising of the street surfaces in the Lion Walk area took place in the Flavian period when the existing street surfaces were covered with a thick layer of burnt daub (Sxs 4 & 42, microfiche, & Sx 58, Sheet 6a). This was very mixed and probably was of Boudican origin. Considerable quantities of burnt daub must have been amassed during the rebuilding operations in the 60s and the disposal of the debris must have been a major task in itself. Thus it would not be surprising if large amounts of the debris were still readily available for many decades afterwards. Probably there were great dumps of it not far from the town.

Alongside the east-west street on the north side of *Insula* 37 was a series of three drains. The earliest was RF52 which was of Period 3 (Fig 36, Sheet 1a). This was followed by two other drains RF35a and RF35b, both of Period 4 (Fig 41, Sheet 1a). The drain RF35a was timber-lined and the traces of the timbers still survived. Feature RF35b contained no sign of decayed wood and perhaps was not a drain but a slot of some kind.

Site U at Lion Walk was a small site which resulted from the excavation in advance of some foundation-trenches for the new Public Library. The results of this work are summarised in Figure 58 (microfiche). The principal features located were some Roman foundations and the north-south street between *Insulae* 35 and 36. The earliest metallurgy lay directly on the natural sand thus indicating that it was military in origin.

## Anglo-Saxon huts

[LWC Sites K & J, general plans Fig 59, p74, detail plan Fig 61, Sheet 2b]

Two huts were found both of which are described and illustrated in *CAR* 1, 1-7. The floor of Hut 1 was sunken and dug against a foundation of Building 19. Hut 2 was built on the site of Room 1 in Building 20. Its floor seems to have been of timber. The hollow below the floor cut through the demolition debris of

FIG 61

FIG 60

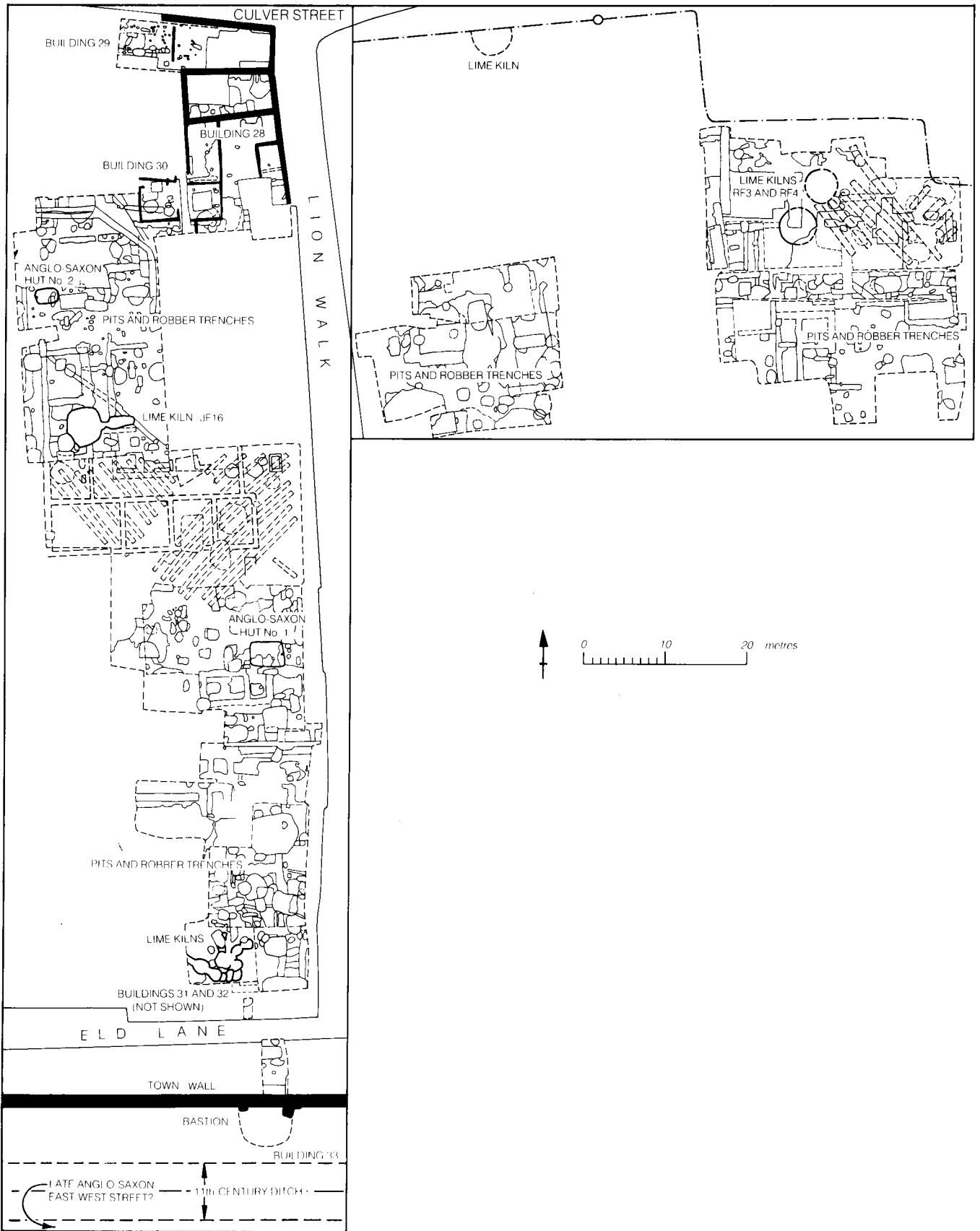


Fig 59 Lion Walk post-Roman remains: general plan. [Pages 73-92]

Building 20 and into the tessellated pavement below. The west posthole of Hut 2 was placed close to the inner edge of the foundation of the east wall of Room 1 in Building 20. Around Hut 2 there was a scatter of stake holes. These were probably associated with it although they have been linked with the late Roman occupation found in this area (p70). Close to the hut were three pits (HF32, HF38, & HF55) which may have been of Anglo-Saxon origin. In the bottom of each of these were many lumps of greensand and tile. Pit HF32 was about half full of rubble. Twenty per cent of this was Roman tile and the rest was greensand. Greensand is not commonly found in the Roman town and in the case of these pits it probably came from the rubble base of the tessellated pavement in Room 4 of Building 20. Of the three pits, HF32 was the only one to contain Anglo-Saxon pottery. Only Roman material was found in the others.

### Robber trenches and post-Roman pits

[LWC; general plan Fig 59, p74; detail plans Figs 60 & 61, Sheets 2a & 2b]

The robber trenches were nearly all of 11th- or 12th-century origin although a few may have belonged to the 13th century (eg BF18/59/60). They were dug to recover building materials from foundations of 2nd- to 4th-century date. There were two exceptions: the Period 1/2 plinths of Buildings 4 and 5 were robbed in c 60-100 (p50) and the inner face of the town wall was removed in c 1400 (pp71-2 & 84). Otherwise, apart from the Anglo-Saxon huts and the rubble-filled pits of Site J, the robber trenches almost invariably represented the earliest evidence of post-Roman activity on the sites. One clear exception was LF266 which was an 11th- to 12th-century pit. This had been dug down the inside of two foundations which subsequently were robbed out (Fig 44). Of note is that all the robber trenches on Site G predated Building 28.

The dates of the post-Roman pits ranged from early medieval to the 20th century. Probably very few pits if any had been dug before c 1050/1100 which reflects the fact that the Lion Walk site was some considerable distance from the High Street where, until perhaps the 12th century, occupation in the town was concentrated. There was however a spread of Thetford-type ware over the site (CAR 1, 33 & 70) indicating activity of some kind in the area during the 10th and 11th centuries. The plan in CAR 1 (Fig 29) showing the distribution of Thetford-type ware in Colchester needs revision since it probably includes sherds from the Middleborough kilns (pp186-9). These were 12th century and produced vessels which were in the Thetford-ware tradition. The kilns were discovered after CAR 1 was completed.

### Building 28 (c 1150 onwards)

[LWC Sites D & G; general plans Fig 59, p74, & Fig 61, Sheet 2b; large-scale detail plans Figs 62 & 67, Sheet 2a; large-scale plans of small areas Fig 64, p77, Fig 65, p78, Fig 66, p79; photograph Fig 68, p80]

Building 28 (Figs 59, 60, 62-8) was of three phases

and probably originated as a first floor hall built of reused Roman rubble. In CAR 1, the surviving above-ground remains and their interpretation are summarised and discussed (pp 53-4, fig 45) and the other stone buildings of early medieval Colchester are described (pp 54-70).

### The surviving wall

[LWC Sites D & G; Fig 63, p76]

The north wall of Room 1 survived to first floor level at the time of the demolition of the house in 1971 (Fig 63). The wall incorporated evidence of a number of structural changes. Originally it contained in the centre a round-headed doorway of 12th-century date. At the west end was part of another opening. This seemed to have been round-headed. It was certainly a primary feature of the wall although whether this had been a doorway or a window was not clear. Another original feature was a small recess in the centre of the south side of the wall. A two-centred doorway was inserted into the east end of the wall in the 13th or 14th century. The arch was not the full thickness of the wall but had to the south a wooden lintel which still survived. The central doorway was reduced in width with the building of a new west jamb. Although there was no trace of it, a corresponding jamb may have been on the east side so that together the two could support a wooden lintel. Later most of the eastern half of the wall was rebuilt and the two central and eastern doorways were blocked. The new part of the wall was built of freshly cut greensand. The relationship of the rebuilt section to the other structural changes and the absence of brick in it suggest that this work dates to between the 14th and 16th centuries. The date c 1500 seems most likely since this is when Phase 2 of the building was constructed.

### Phase 1 (c 1150 to c 1500)

The foundations of Phase 1 (Fig 62) consisted of trenches filled with Roman rubble. These were cut through robber trenches of 11th- or 12th-century date (Figs 42 & 70). One of the trenches (GF233) contained a coin struck between 1066-87 and lost probably by c 1095. The southern foundation of Room 1 sealed a coin minted c 1105 and lost probably by c 1115. This evidence, in conjunction with the presence of a round-headed opening in the wall which survived until 1971, places the construction of Phase 1 between c 1115 and 1200. A date of c 1150 is taken as a suitable estimate. During Phase 1, Building 28 underwent many substantial structural changes. Originally there was only Room 1. To this were later added Rooms 2a and 3a with Room 2a probably having been first because its foundations were very similar to those of Room 1. The north end of the foundation of the east wall of Room 3a stopped short of the southern wall of Room 1 thus showing that it was a later addition. The foundations of Room 2a were of rubble (Sx 30, microfiche) whereas those of Room 3a consisted of packed layers of broken up and powdered mortar (Sx 28, microfiche). The base of the wall between Rooms 1 and 2a survived for most of its

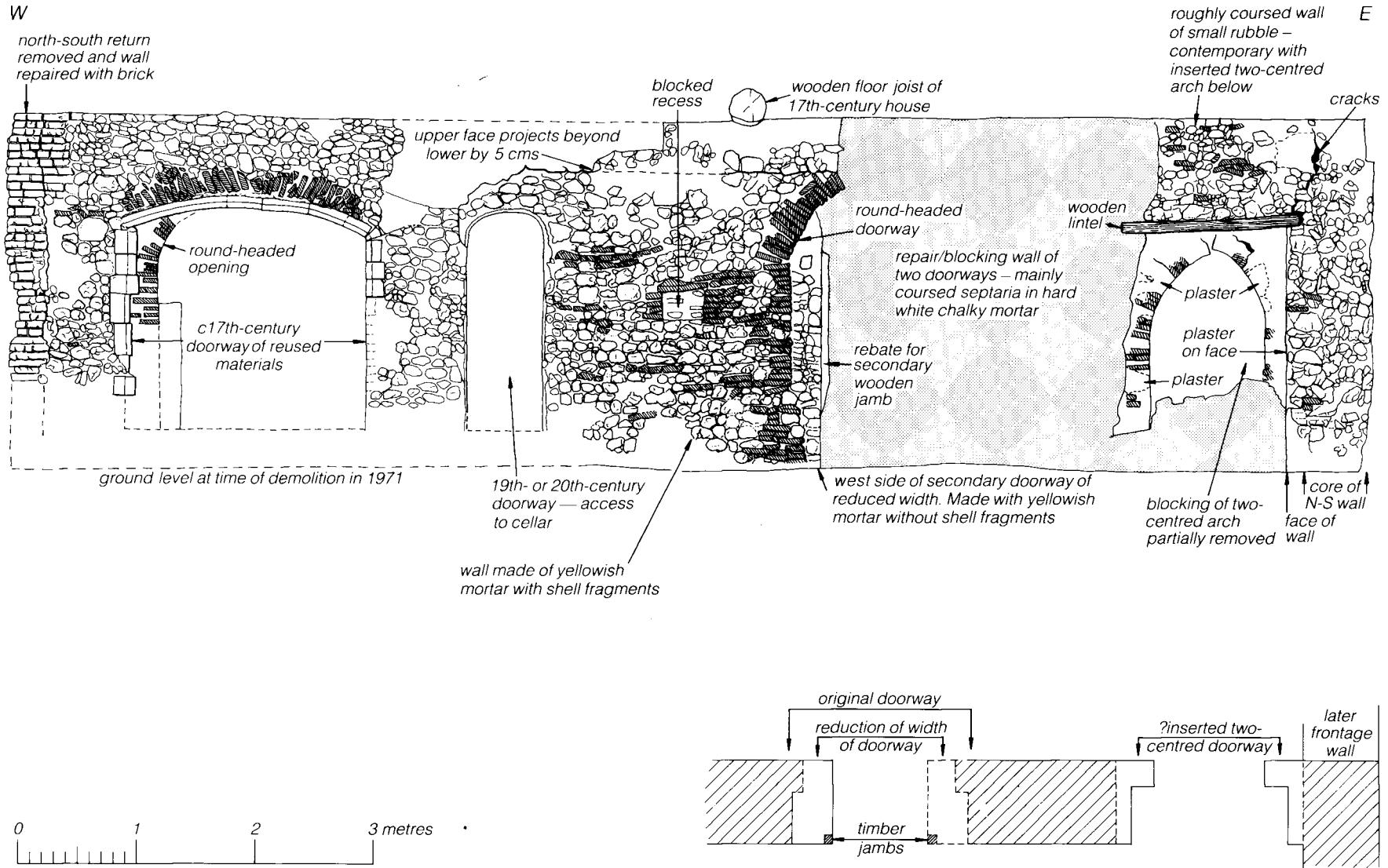


Fig 63 The southern elevation of the northern wall of the hall block of Building 28. [Page 75]

length but there was no sign of a doorway although this must almost certainly have existed. Perhaps it had been at the west end where only the foundation survived. A doorway was cut through the south wall of Room 1 when Room 3a was built. Room 2a was demolished and replaced by a boundary wall along the east side of the property. By this means the south yard was enlarged to include the area formerly occupied by Room 2a. The butt joint between the new boundary wall and the wall of Room 1 was clearly visible. Another wall was added on the north side of Room 1 to make Room 4. The resulting butt joint was observed. Previously the area had been a yard. The new north wall had a doorway on to Culver Street and unlike the other walls it contained a few fragments of glazed tile.

The principal room of Building 28 in Phase 1 had been Room 1 which was the hall block. None of the floors of Phase 1 were made of material laid down for the purpose. The floor areas had simply been cleared of loose soil and beaten or trampled flat. Most of the west end of Room 1 was destroyed when a cellar was built in the 19th or the 20th century. The surviving area of the room contained many features (Figs 62 & 64), the principal one of which was a square stone-filled pit (Fig 62; GF214). The latter was neatly placed at one end of the room being roughly equidistant from

the east, north and south walls. The feature may have been the base for a Sampson's post in which case there would have been a similar pit in the corresponding position at the west end of Room 1. Pit GF71 appeared to have been used for lead-working. It was bowl-shaped, had burnt sides and contained many fragments of lead (Appendix 7, p 215).

Room 2a contained a patch of intensely burnt daub (GF90) which was probably the remains of a hearth. A layer of rubble in the middle of the room was probably demolition debris rather than part of a structure.

Under Room 3a and predating it were some pits and part of an east-west robber trench (Fig 65). Some of the pits were contemporary with early Room 1. This was certainly true of the large 12th-century cess-pit GF241 which was sealed by the southern foundation of Room 3a. Unlike Rooms 1 and 2a, the area within Room 3a had been lowered during the construction of the room. It was reduced by 0.1 to 0.2 m to provide a good surface for the floor. At the south end the gravel of the Roman street was exposed and the surface was so good that the foundations of the south and east walls were reduced in depth in this area. Room 3a contained many stake holes, several small pits and the remains of a baby buried in a shallow grave (GF224) about 0.2 m below contemporary ground-level. This was without a coffin and lay on its back with its head to the west. Also the floor had been burnt in patches mainly along the east wall. These burnt areas were probably caused by hearths, the clearest being in the south-east corner where the inner face was curved inwards to form what was presumably the back of a hearth. To the south of Room 3a were two short lengths of parallel foundations. Their purpose is obscure.

In the yard was a large timber-lined pit (GF234; Fig 65; Sx 26, microfiche) which was probably a storage pit. The remains of six, possibly seven, postholes survived all of which were to the inside of the timber-lining. The southern half of the west side of the pit had collapsed in antiquity because of the weakness in the side caused by the presence of the foundation trench for the east wall of Room 3a. This indicates that the storage pit was open when the foundation was in existence. The pit contained a substantial quantity of 12th-century pottery thus showing that Room 3a was built in that century. The yard was surfaced with gravel.

Room 4 may not have been a room but a yard or a garden. Section 25 supports this interpretation although the dimensions of the area enclosed by the frontage wall would suit a room. Very little of Room 4 survived because most of it was destroyed during the construction of a modern cellar. At first the area was probably a yard on the north side of Room 1 until the stone wall on the east and north frontages was built and Room 4 was formed. The wall survived to a height of 0.6 m. There are no layers of gravel in the surviving floor levels in the south-east corner. The west limit of Building 28 was not clear but is indicated by the west end of the north wall of Room 4. Of the features which were south of this wall and on Site D, the earliest

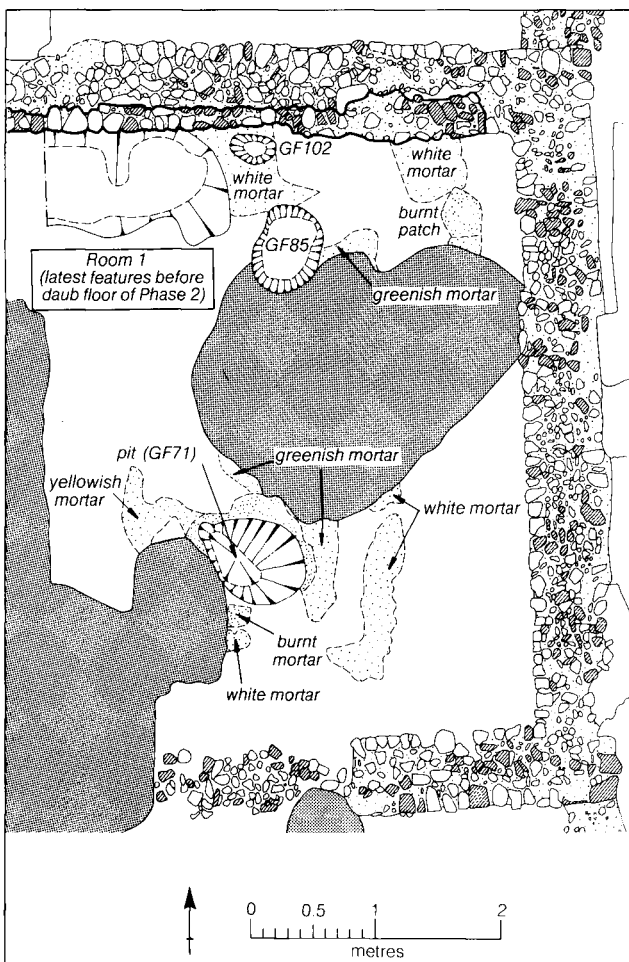


Fig 64 The east end of Room 1 of Building 28. 1:60. [Page 77]

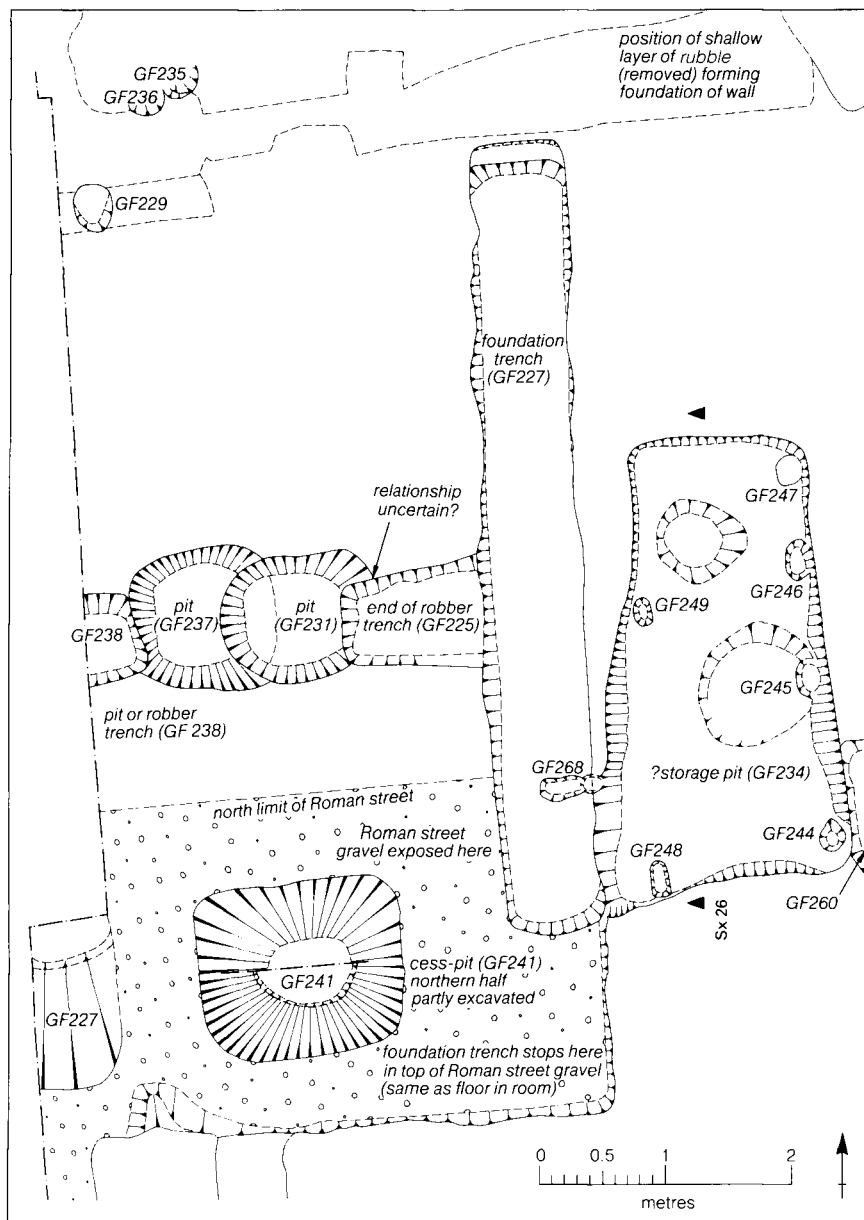


Fig 65 Features under Room 3a and timber-lined pit (GF234) in the yard of Building 28. [Page 77]

were outside Room 1 and in the north yard. These are shown on Figure 62. The wall DF24 was a party-wall between Buildings 28 and 29. To the east of it were some postholes and small pits which must have been inside Room 4 of Building 28. The glazed tile which occurred in the frontage wall north of Room 1 suggests that Room 4 was probably built in the 15th century. Of a sample of this tile (ref no S228), Mr Paul Drury writes: a fragment of a large, thick (45 mm), once glazed, Flemish floor tile originally used complete in a hearth and re-used in the wall. Despite burning it appears to be exactly similar to another fragment of glazed tile (S43) whose single, central nail hole suggests that it was about 260 mm square. Both have a plain, brown glaze which on tile S228 has been reduced to green. These tiles are most unlikely to predate the 15th century and could be as late as the

mid 16th century (Drury & Norton forthcoming).

By the end of Phase 1, the roof over Room 3 must have been in a poor state because the yard had become littered with fragments of peg-tile which had slipped from the roof (Fig 66). The distribution of the tile stopped short of the east wall of the room and thus reflects the eaves above. Oddly the spread of tiles seems to suggest that the line of the east wall of Room 3a continued southwards despite there being no other evidence of this.

#### Phase 2 (c 1500 to c 1650/1750)

Building 28 (Figs 67 & 68) was substantially rebuilt possibly in stages over a period of years in c 1500. It is difficult to establish exactly which stone walls of Phase 1 were retained and which were demolished.

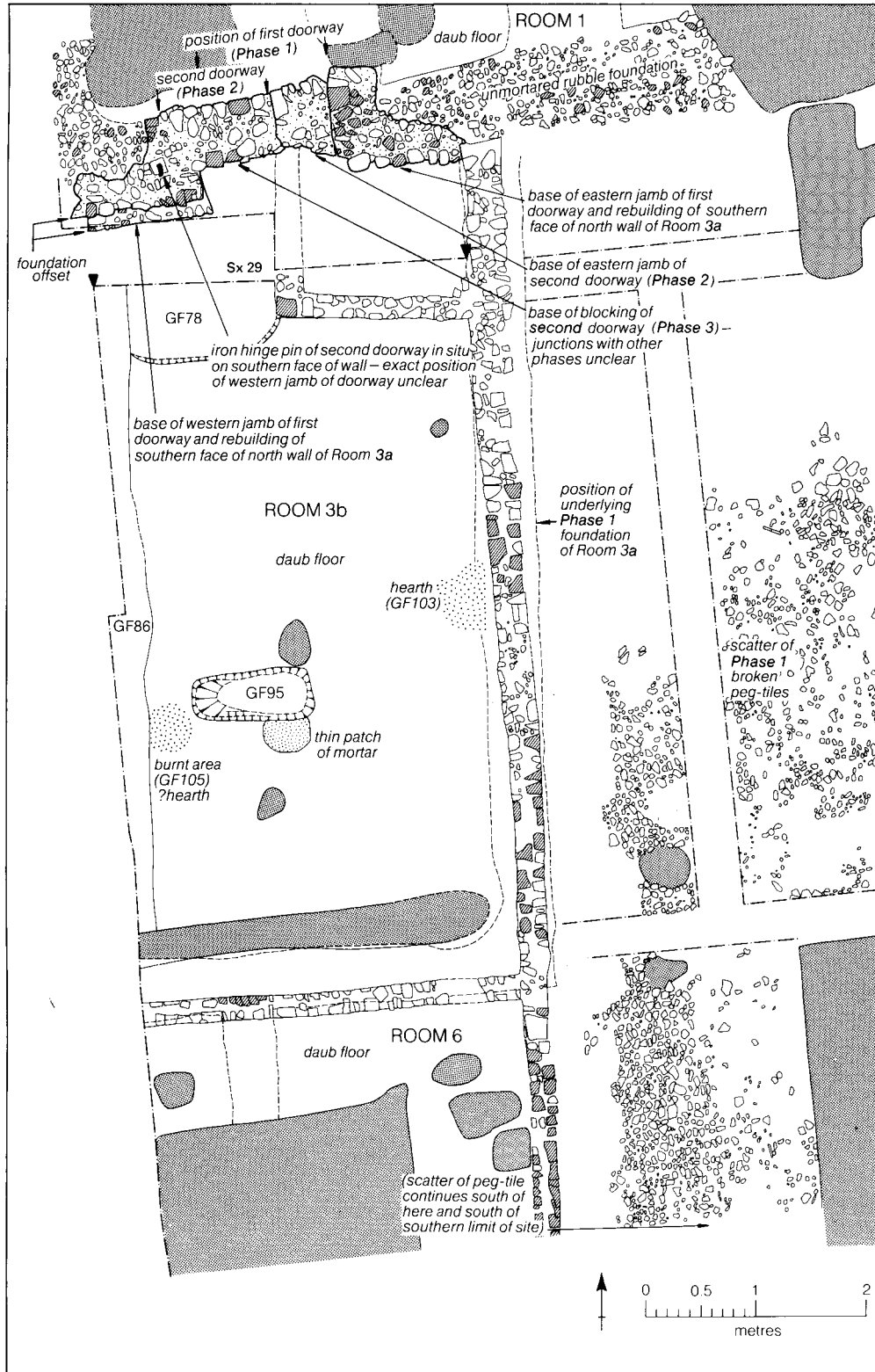


Fig 66 Rooms 3b and 6 and the spread of broken peg-tile in yard of Building 28. 1:60. [Pages 78-81]



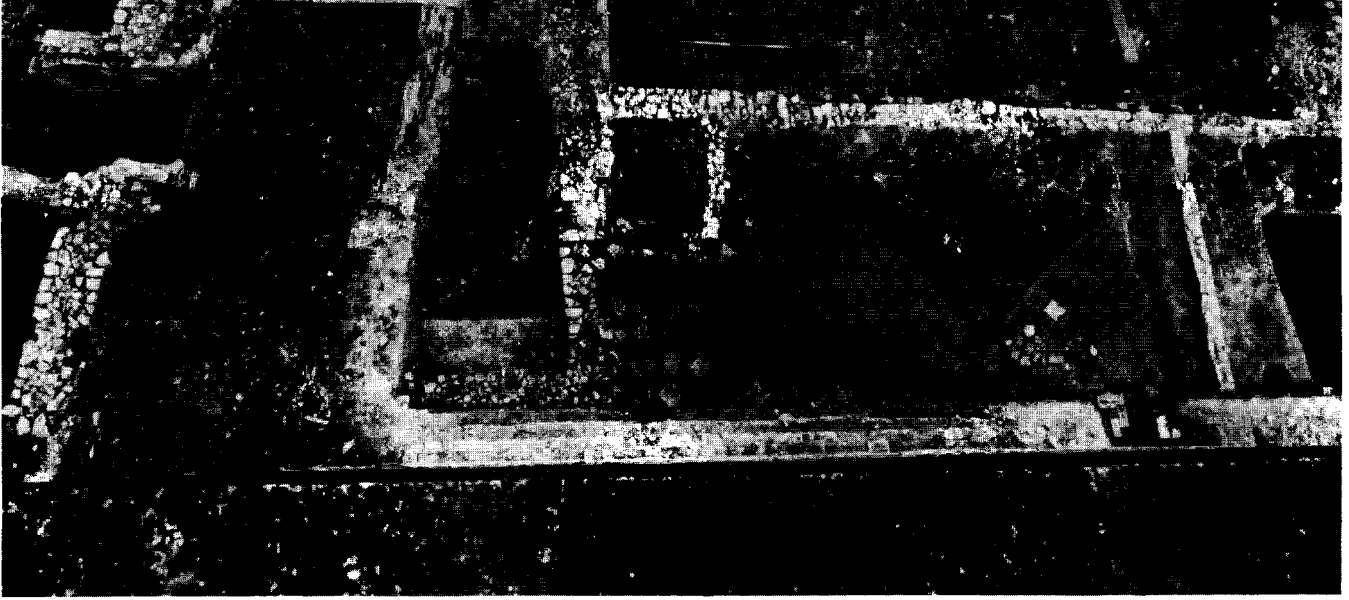


Fig 68 Building 28, Phase 2, from the west. [Pages 78-81]

But certainly Room 3a was knocked down. Room 1 and the frontage walls all seem to have been kept. Floors of clean yellowish daub were laid in Rooms 1, 3b, 4, 6, 7, and 8 (Sx 23, microfiche). The new floor in Room 1 partly sealed the base of the east end of its south wall indicating the position of a possible inserted doorway (Fig 67). The new walls of the rebuilt house were timber-framed with ground-plates on mortared plinths mainly made with broken peg-tile laid horizontally or stacked at a slight angle. These formed the walls of the Rooms 3b, 6, 7, and 8. The plinth at the north end of the east wall of Room 3b was of mortared rubble.

Room 2b is hard to define since no west wall was found. Room 2b may not have existed as such but instead may have been the north end of an L-shaped yard. This is unlikely and the traces of a west wall have probably been removed. The part of the site was clearly built over by the time of the earliest detailed map of Colchester (Morant 1748) yet in this part of the site no evidence survived of the walls which this and all later maps imply had existed.

Later in Phase 2, a floor of yellow and black tiles (see below) was laid in Room 3b. It was set in a thin layer of

mortar on top of a thin bed of sand (Sx 29, microfiche). The tiles were worn to such a degree that the glaze only survived in the north-west corner of the room. At the south end, the floor had been extensively patched with unfrogged brick of 16th- or 17th-century date. Together the pattern of wear and the position of the repairs reflect the pattern of use of the floor. Clearly there had been a doorway at the south-west corner between Rooms 3b and 8. In the north-east corner of the room was a small compartment or room which measured internally 1.5 x 1.2 m. This had a daub floor and was built with timber-framed walls on plinths in the same manner as the Phase 2 walls elsewhere. The walls and floor of the compartment were contemporary with the walls and the tile floor of Room 3b (Sx 29). The doorway between Rooms 1 and 3a was reduced in width presumably when Room 3b was built (Figs 66-8). The base of an iron pin which had been part of the lower hinge of the Phase 2 door was *in situ* (Fig 66). The east jamb of the Phase 2 doorway lined up with the west face of the compartment in the corner of Room 3b. The reduction in the width of the doorway is similar to the alterations made to the central doorway in the north wall of Room 1 and thus the two events may have been part of the same operation.

Room 4 (Sxs 23 & 25, microfiche) had many postholes similar to those in Building 29. The resemblance was such that there is the possibility that Room 4 was part of Building 29. Along the south side of Room 8 was a well-made path of broken peg-tile (GF93) set on edge. This led from a gravelled yard laid out to the west (Site E) in about the 16th century.

A fragment of crested ridge tile (Fig 69) was found in a pit (EF20) of 17th- to 18th-century date and thus probably derived from the roof of Building 28, Phase 2 (see report below).

### Phase 3 (c 1650/1750-1972)

[Included on Fig 67, Sheet 2a]

The changes which took place in Phase 3 were difficult to detect mainly because most of the archaeological remains of this phase were near the surface and were destroyed by the demolition contractor. Also it is difficult to rationalize the remains which were excavated with the sequence of buildings shown on the available maps (Morant 1748 onwards).

The major influence in Phase 3 was the building of Trinity House (Building 30) because this encroached on to the west side of Building 28 and required the demolition of existing structures. The west side of Building 28 seems to have been demolished but, after appropriate alterations, the rooms on the street frontages were kept. Room 6 and the small compartment to the south were knocked down in the 17th century and pits were dug in the area (GF24-7 & GF29-31). These produced some substantial groups of 17th-century pottery.

New wooden floors were probably laid throughout Building 28. These left little trace except for some rotted joists in Rooms 2b and 4 (not all illustrated). A chimney-stack was inserted into the building in the 17th century, pottery and brick of this date being found in its rubble-filled foundation (GF55). The latter was the characteristic H-shape showing that fire-places existed to the north and south. The date of the insertion is in keeping with the period when open halls were frequently converted into two-storeyed blocks with brick chimney-stacks (p29) although the situation here was more complex and obscure because the building was already two-storeyed. The oldest part of the building surviving in 1971 at first floor level was of c 17th-century date and over Room 4. Most of the south yard was built over to leave a much narrower open area.

### The floor of glazed tiles and a crested ridge tile

by P J Drury

The floor GF12 (Fig 67) was primarily composed of Flemish tiles, identifiable as such by nail holes in the faces. They were about 235-40mm square, 30mm thick, finished either with a plain lead glaze (firing dark greenish-brown) or a similar glaze over a white slip (firing yellow), laid chequer fashion in the usual

way. A repair (Fig 67) of mixed, probably reused, material included a few small Flemish tiles of three sizes (120-125 mm, 105-7 mm, and 103 mm square) each with four or five nail holes. Fragments of all four groups also came from secondary contexts associated with Building 28. Fragments of large Flemish tiles of three other groups were found loosely associated with the building; one is of distinctive early 16th-century type. The dates of the remainder are imprecise; the small ones are late 14th to mid 15th century, whilst the large ones are of 15th or early 16th century date (Drury & Norton forthcoming). All seven groups were probably used somewhere within Building 28 at various dates over perhaps a century and a half. Latest of all is a fragment of a local unglazed pavement tile of mid 16th century or later date also used in the repair of the floor GF12.

Glazed tile floors began to appear in burgess houses in the major towns during the later 14th century (Eames 1975, 6-8). Plain Flemish tiles are ubiquitous in East Anglia and it is likely that many of the major houses in Colchester had such floors by the 15th century. Apart from Building 28, at least one other house in the vicinity of Lion Walk probably had tiled floors, for the site assemblage also includes plain locally-produced tiles both small (115 mm) and large (two groups, all fragmentary) and contemporary with the Flemish tiles of similar size. Even the Middleborough site has produced a small group: tiles 115 mm square, both Flemish and English (the latter exactly like the Lion Walk tiles) and fragments of large plain Flemish tiles.

A comprehensive study of the floor tiles from Colchester is planned for a later volume of the *Colchester Archaeological Reports*; for their regional setting, see Drury and Norton forthcoming.

A fragment of a ridge tile with a knife-cut crest (Fig 69; Site E, F20) was loosely associated with Building 28, Phase 2. It is in a hard sandy fabric, orange brown with a reduced grey core, and glazed dark brown on the outside. An elaborate crenellated and spiked pattern seems probable, like those from West Bergholt Church, Colchester (Drury forthcoming a).

Crested ridge tiles are rare in Essex and East Anglia. This fragment, together with those from West Bergholt and others from Harwich, Essex (from

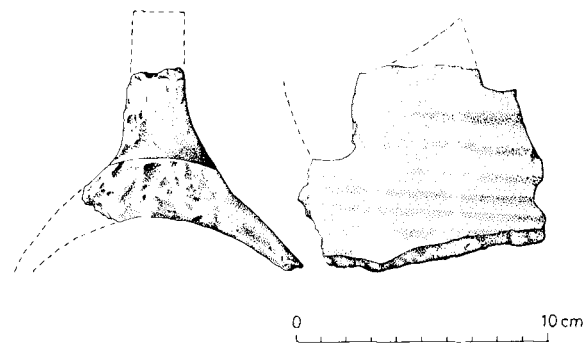


Fig 69 A fragment of crested roof tile. [Page 81]

unpublished excavations by S R Bassett) are probably the products of a single local centre operating at some time between the mid to late 13th and the end of the 14th centuries. ■

### **Building 29 (medieval & later)**

[LWC Site D; general plans Fig 59, p74, & Fig 61, Sheet 2b; large-scale detail plans Figs 62 & 67, Sheet 2a; plan of features predating building Fig 70, p83]

The earliest post-Roman activity predates Building 29 and is mainly represented by robber trenches and pits (Fig 70). Most of these are of c 12th-century origin but some of the pits belong to the 13th century. There was no evidence of any structure in this period on Site D apart from a deep posthole on the north side.

The subsequent occupation up to modern times is attributable to Building 29 and can be divided into three phases: Phase 1 dating c 13th-14th to 16th-17th centuries, Phase 2 dating c 16th-17th century to c 1650-1700, and Phase 3 from c 1650-1700 onwards. It is not possible to determine whether these represent one building altered twice or whether there was more than one building concerned. The foundation DF24 was probably a party-wall between Buildings 28 and 29 and thus makes interpretation more complex. There is moreover the additional complication that Phase 3 might have been an extension of Building 28. The nature and position of the external walls of the building in Phases 1 and 2 are obscure.

The earliest floor of Phase 1 (Fig 62) was of gravel. This was cut by some stake holes but there were no clear traces of walls. The gravel floor was replaced by one of daub (DF107). Some topsoil survived between the earliest occupation and the latest Roman and contained slate and a glazed sherd of c 13th-century date. The earliest occupation thus seemed to be of the 13th or 14th century.

In Phase 2 (Fig 67) many large square posts were erected some of which were dropped into a large east-west construction trench (DF32). The building was clearly altered very extensively. The scale of the new structure was in marked contrast to that of Phase 1 suggesting that the whole may have been rebuilt. Predominantly the posts seem to have been 17th century in date but several were later replaced and the plan is difficult to interpret in terms of rooms. The method of construction did not require ground-plates and therefore the ends of the posts must have been susceptible to wet rot. However the builders may have felt that the danger was minimal because the posts were inside the building.

In Phase 3, a brick floor was laid to form a north-south passage on the west side of DF24 and many, if not all, of the walls were rebuilt in brick. The wall on the south side was of brick without frogs. The party-wall DF24 was kept. (The remains of Phase 3 are not illustrated here but details are available in the site archive.) Earlier in the 20th century, part of Building 29 was used as a paint shop. This probably accounts for the odd yellowish staining which originated in the latest levels and obliterated much detail in the

stratigraphy (Sxs 22 & 24, microfiche). It was presumably caused by spilt chemicals.

### **Building 30 (Trinity House; 18th to 20th centuries)**

[LWC Sites D,E,G, & H; general plan Fig 59, p74]

Very little of Building 30 was excavated. Part of the foundation of the east end of the south front was found on Site E. This was of unfrogged brick and had been part of a bay window. The frontage wall of Trinity House was traced for about half the length of Site E. At the south end of EF9, which was the west end of the bay window, the wall (EF6) turned sharply by about 45 degrees and continued westwards along the edge of site E for 4.5 m. It then formed a right-angled corner and headed northwards under the baulk. This ties up with a 19th-century sketch of Trinity House where two bay windows are shown on the south side. The drawing is in a brochure prepared for the auction of the property in 1887 (archive of the Essex Archaeological Society). The centre of the bay window was not built on a continuous foundation but on several brick piers of which three were uncovered (EF3, EF4, & EF8). The south wall of a recent cellar was found in the south-west corner of Site G and was another part of Building 30.

### **Building 31 (17th to 20th centuries)**

[LWC Site L; detail plan Fig 71, microfiche]

Building 31 appeared to have been part of the original almshouses constructed by Lady Darcy along the northern frontage of Eld Lane. According to Morant (1748, Bk 3, 9), these were built during the reign of Charles I and were of brick. The part examined during the Lion Walk excavations was on Site L where rubble foundations (LF39) were uncovered (Fig 71). The floors were of daub and the base was found of a brick chimney-stack. This was H-shaped showing that it had a fireplace to either side. It may have post-dated Building 31 and have belonged to Building 32. The rubble foundations included two north-south returns which supported either internal walls of two houses as shown in Figure 71 or party-walls between three separate houses. Part of the foundation of the frontage wall was uncovered at the south end of the site. The daub floors contained 18th-century material and thus were either secondary or else they indicate that Building 31 was itself a replacement for an earlier building.

### **Building 32 (20th century)**

[LWC Site L; detail plan Fig 71, microfiche]

The almshouses were rebuilt as two rows of terraced brick houses in 1897 and 1905. Either the brick chimney-stack was built at this time (although the bricks were not frogged) or it was retained from Building 31. The back gardens of two of the houses were within the area of the excavation. The northern boundary of the properties took the form of a brick wall.

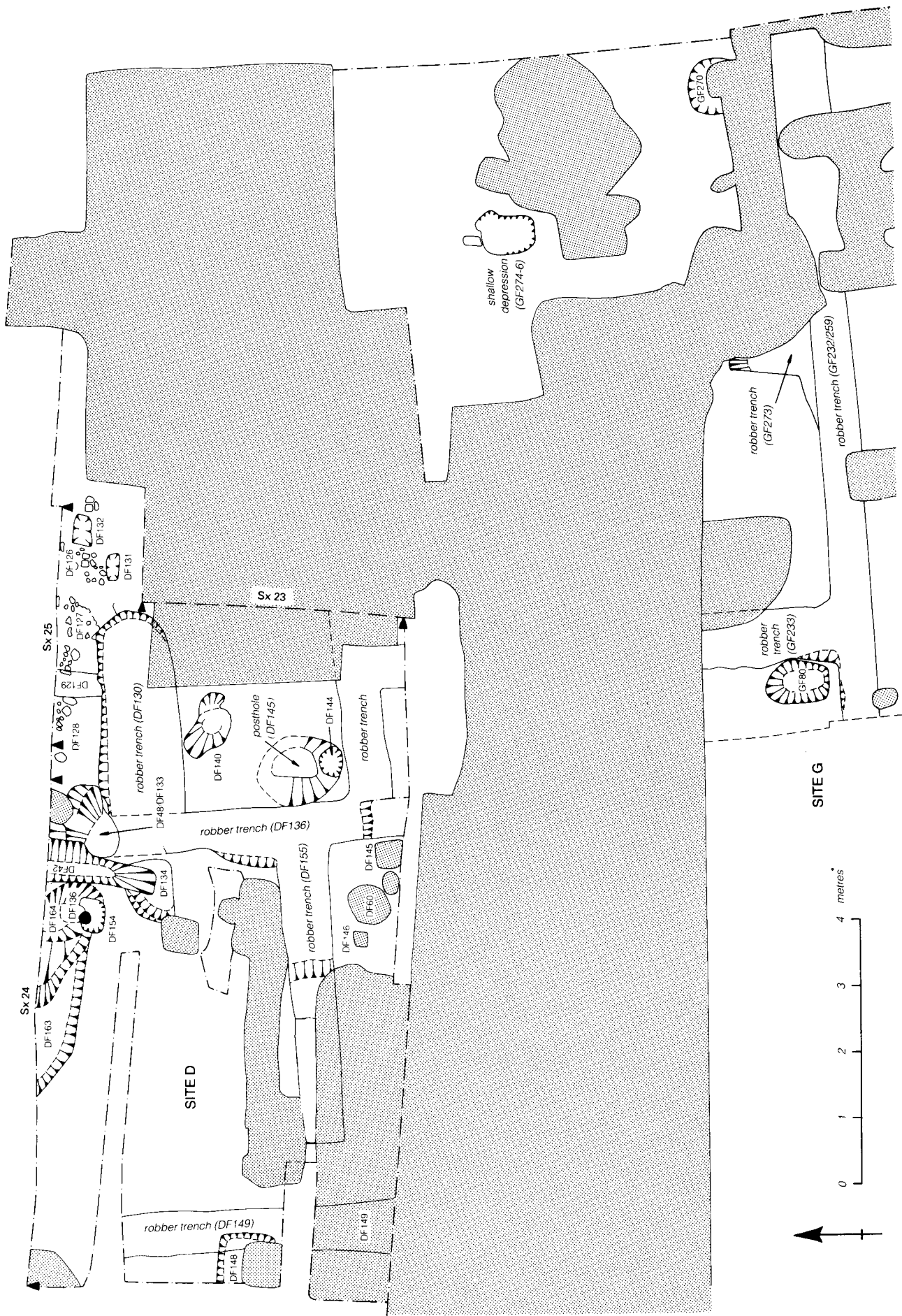


Fig 70 Post-Roman features under Building 29 and northern half of Building 28. [Pages 75 & 82]

## Building 33 (post-medieval)

[LWC Site N; general plan Fig 59, p 74; detail plan Fig 61, Sheet 2b; large-scale plan Fig 72, p85]

In the section across the town ditches, part of a building was uncovered (Fig 72). The remains consisted of a daub floor, a mortared plinth (NF14), a slot or pit (NF15), and two large postholes (NF9 & NF11). The plinth was made of stone and mortar and would have supported a timber ground-plate. The north end of the daub floor, although damaged, probably when the house was demolished, sealed 15th-16th century pits NF17 and NF18. Pit NF17 had been dug down the side of the medieval bastion. According to the stratigraphy (Sx 55, Sheet 6a), the house and the bastion were contemporary and both seem to have been demolished about the same time. The remains of the house were not substantial which is consistent with the notion that the house did not last long. The floor was thin with no make-up below and no noticeable occupation above. Also there was no evidence of any structural changes. It was built at the earliest between c 1450 to 1500 (the earliest possible date for pits which it sealed) and was demolished probably during or just after the Siege of Colchester in 1648. Thus the house existed for 150 to 200 years at the most and probably very much less.

## Medieval bastion and the refacing of the town wall (Bastion 8)

[LWC Site N; general plan Fig 59, p 74; detail plan Fig 61, Sheet 2b; large-scale plan Fig 72, p85]

The bastion (Fig 72) was built with reused Roman building materials; no peg-tile, slate or post-Roman brick was present. It was semi-circular in shape and measured externally 6.9m in diameter. It was contiguous and contemporary with a refacing of the Roman wall. This was 0.3m thick and made of the same materials as the bastion. The area of refacing which still survives contains putlog holes. These are characteristic of medieval work elsewhere in the wall (ie next to Bastion 5 and next to the North Gate). The refacing of the wall seems to have started at the ground level of the time or perhaps a little lower whereas the bastion had foundations approximately 1.1m deep. The ground level at the time of the construction of the bastion was much lower than it had been in Roman times because at the foot of the wall there had been erosion of the berm into the ditch (p 15). When the bastion was built, the ground level in this area was 1.5m lower than the construction level of the wall with the effect that the base of the wall foundation was higher than the ground level to the south. Also the outer face of the town wall was missing and its core was exposed. Presumably the face had been robbed for tile in Anglo-Saxon or early medieval times. In addition, the part of the foundation which had been directly under the outer face had also been robbed although this would have contained only

septaria. The refacing of the wall was of double thickness where it continued below the base of the wall foundation.

The date of the construction of the bastion and thus also the refacing is hard to establish from the archaeological evidence alone other than that both were post-Roman. The degree to which the ground-level has changed and the fact that the wall had lost its outer face before the bastion and the new face were constructed make it certain that these could not have been Roman additions to the wall. However it is known that the wall was being repaired in 1312 (*Court Rolls*, 5.6.1312) and that from at least 1382 until 1421 a prolonged programme of repairs was underway (Hull 1958, 15-6). The bastions are generally attributed to the latter period because the scale of the work concerned seems to have been substantial. The rear face of the Roman wall behind Bastion 8 was robbed in the 15th century. The robber trench (MF53), found on Site M (Sx 54, Sheet 6a), is curious not only for its date but also because it involved the town wall. Certainly at this time the wall was well cared for because, in addition to the repair work, cases were brought against townsfolk for robbing the wall or digging too near it (*Court Rolls*, 26.6.1346, 16.4.1352, 28.4.1354, 27.4.1360, 17.1.1373, 2.5.1379, & 2.10.1374). The robber trench (MF53) was very deep and the work very thoroughly done so that perhaps it was official and dug to obtain material to repair the wall with and build the bastions?

The bastion was demolished and most of the materials removed for reuse elsewhere. Again there are few finds from the excavation to date this event but it must almost certainly have occurred in 1648 or later. When the bastion was knocked down, a recess was left in the face of the town wall. This corresponded to the inside of the bastion and was where the Roman wall had not been refaced. The recess was neatly filled with a wall of c 17th-century bricks so that the vertical edges of the patch coincided with the inner faces of the bastion.

All that survived *in situ* of the bastion were two stumps attached to the town wall. Further out from the wall was a large fragment which seemed to lie very close to its original position. The outer face of this piece had been garreted using pieces of flint and it contained some fresh pointing in which the score lines of the trowel work were well preserved.

## Eleventh-century ditch

[LWC Site N; general plan Fig 59, p 74; detail plans Fig 61, Sheet 2b & Fig 72, p 85; Sx 55, Sheet 6a]

At the foot of the town wall was a large defensive ditch. It was dug in the late 10th or 11th centuries, probably between 1050 and 1075. The ditch has been discussed and its fill, context, and associated pottery described in *CAR* 1, 33-5, 39-40, & 52.

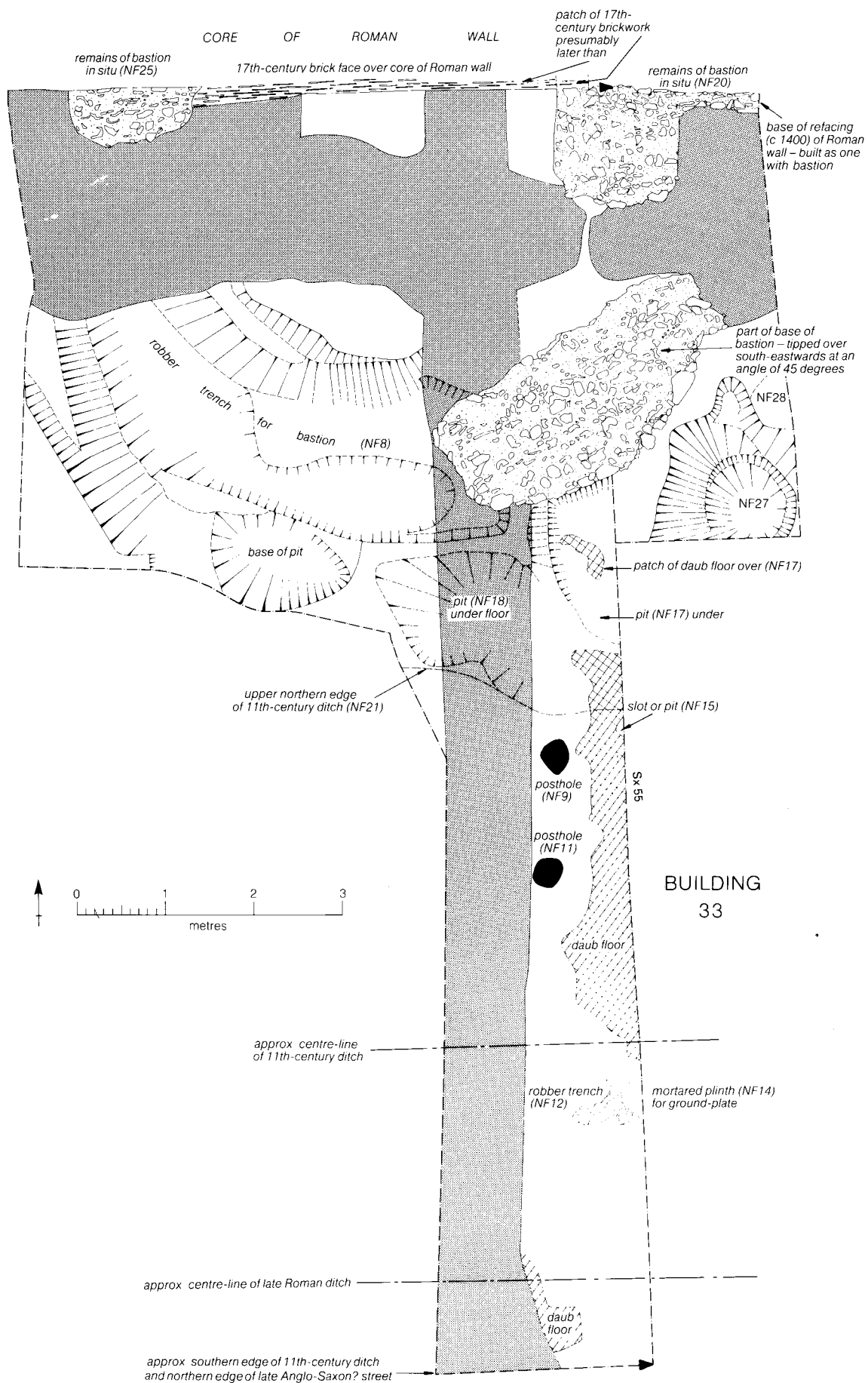


Fig 72 The remains of Bastion 8 and Building 33. [Page 84]

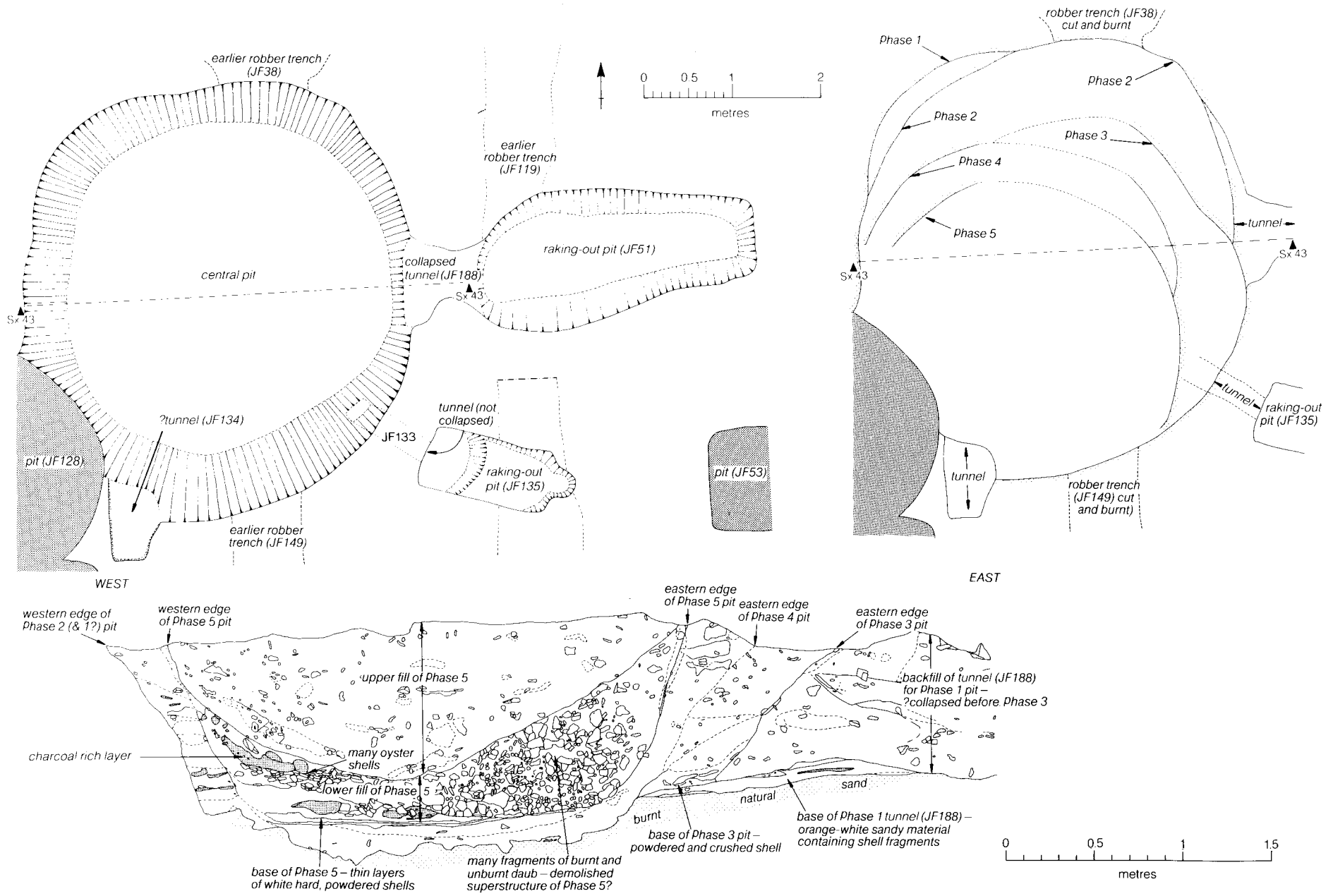


Fig 73 The lime kiln JF16: plan and section (Sx 43, Lion Walk, Site J). [Page 87]



## Medieval lime production

[LWC Sites A/R, J, C, & L; general plan 59, p74; detail plans Fig 60, Sheet 2a, Fig 61, Sheet 2b; large-scale plans Fig 73, p86, & Fig 75, p88; large-scale phase plans, Fig 77, p90; photographs Fig 74, p87, Fig 76, p89; Sx 43, p86; other structural details Fig 78, p91]

As already explained, lime production in the medieval period seems to have been made more efficient by the introduction of a smaller type of kiln (p30). Four lime kilns of the early variety were found at Lion Walk (Figs 59-61) only one of which was fully excavated (Fig 73; JF16). This probably dated to *c* 1150-1250 as indicated by the pottery it contained and by the fact that the kiln cut the *c* 12th-century robber trenches for the foundations of Building 20 but was itself cut by the ?13th-century pit JF128. The other three early kilns were on the east side of Lion Walk (RF3, RF4, & in Sx 61, Sheet 6a). Although unexcavated, the lime kiln RF3 seemed to cut a robber trench (RF27) for Building 25 and thus probably belonged to about the same period as the kiln on Site J. In 1973 a lime kiln of similar type was found in the St John's Abbey Grounds. Although unexcavated, it was quite clearly sealed by the dumped soil of 1133 (CAR 1, 40-1 & fig 36) and therefore was earlier than it. Thus the large lime kilns seem consistently to be of early medieval date.

Five phases were detected within the lime kiln JF16. Apart from the primary phase, each of these represented a re-excitation of the main pit after it had been backfilled and each time the pit was a little smaller than it had been before. The number of firings (as opposed to phases) which had taken place was impossible to determine unless each firing had been equivalent to one phase in which case there could only have been five sessions. However this is unlikely since the degree and the uniformity of the scorching along the sides gives the impression of prolonged and extensive use during each phase.

On the east were two tunnels through which the lime was raked out from the central pit (JF133 & JF188; Fig 73). The northern tunnel had a large raking-out pit at its east end (JF51). To the south, there was a small pit (JF134) with vertical sides which may have been a collapsed tunnel. The south-west part of the kiln had been destroyed when the pit JF128 was dug so that it was not possible to tell if there had been any tunnels here. The precise relationships of the vents to the five phases of pit could not all be established. However each phase could have had two tunnels, one to the east and another to the south. Tunnel JF188 was contemporary with Phase 1 and possibly 2 but, as Section 43 shows, had collapsed before Phase 3. Tunnel JF133 belonged to Phase 3 and possibly Phases 4 and 5. The ?tunnel JF134 could have functioned with each phase.

The backfill of the last phase contained many fragments of daub, some of which were unburnt. The daub was probably the remains of the superstructure. There was no sign of the extensive vitrification which occurred at the smaller kilns.

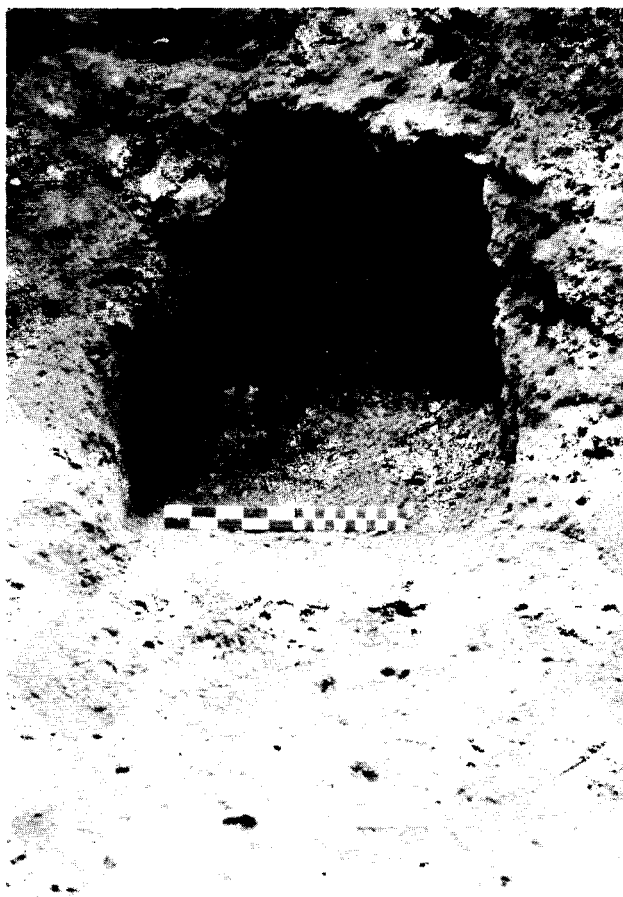


Fig 74 The tunnel JF133 in lime kiln JF16. [Page 87]

Although only uncovered on the surface, none of the other large lime kilns appeared to have been of more than one phase.

The lime kilns of the later type were found as a complex which was on Site L and extended a little into Site C (Figs 75 & 76). The associated pottery indicated that the kilns were of 14th- to 16th-century date. Not only were they sealed by the almshouses (Building 31) but they were substantially earlier than them because there had been sufficient time between the abandonment of the last kiln and the building of the almshouses for topsoil to accumulate to a depth of about 0.6 m. The kilns sealed three pits and a robber trench of which all were probably early medieval.

There were at least nine kilns each of which consisted of a central reducing chamber with two opposing raking-out pits. The lime kilns were not all in use at the same time. Five phases were recognized (Fig 77) which can be summarized as follows:

- Phase 1 .....lime kiln LF125/118
- Phase 2 .....lime kiln LF127/76
- Phase 3 .....lime kilns LF115/98/120, LF124, LF110 (the last two may have been the same kiln)
- Phase 4 .....lime kilns LF98/99/145, LF126/102/145, LF88
- Phase 5 .....lime kilns LF121-2/80/259, LF121-2/79/86







*Fig 76 Complex of lime kilns. Above left: LF88 and LF115/98/120; above right: LF118 and LF115/98/120; below: LF122 and western arch of LF79. [Pages 87-91]*

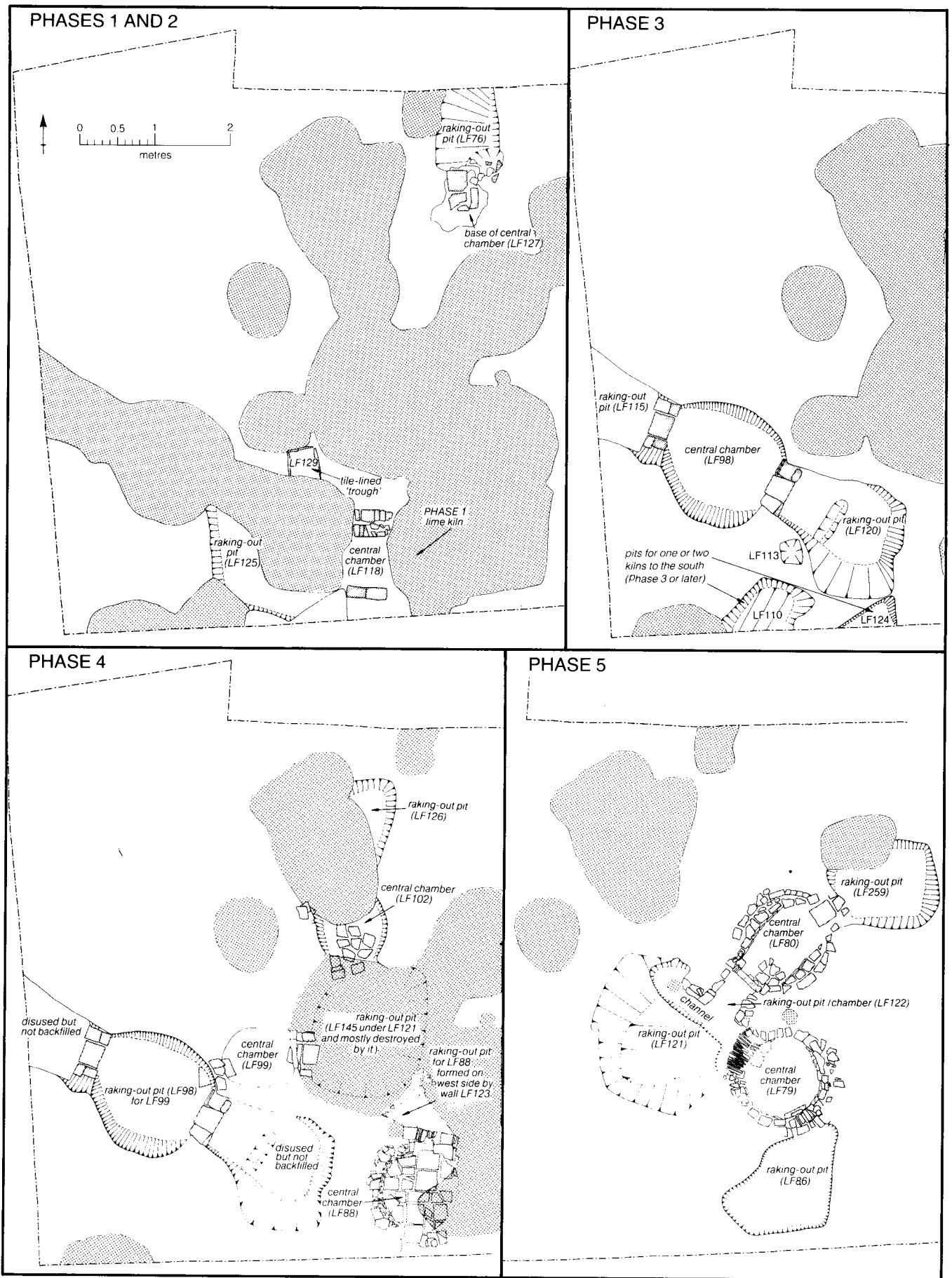


Fig 77 Complex of lime kilns: Phases 1-5. [Pages 87-91]

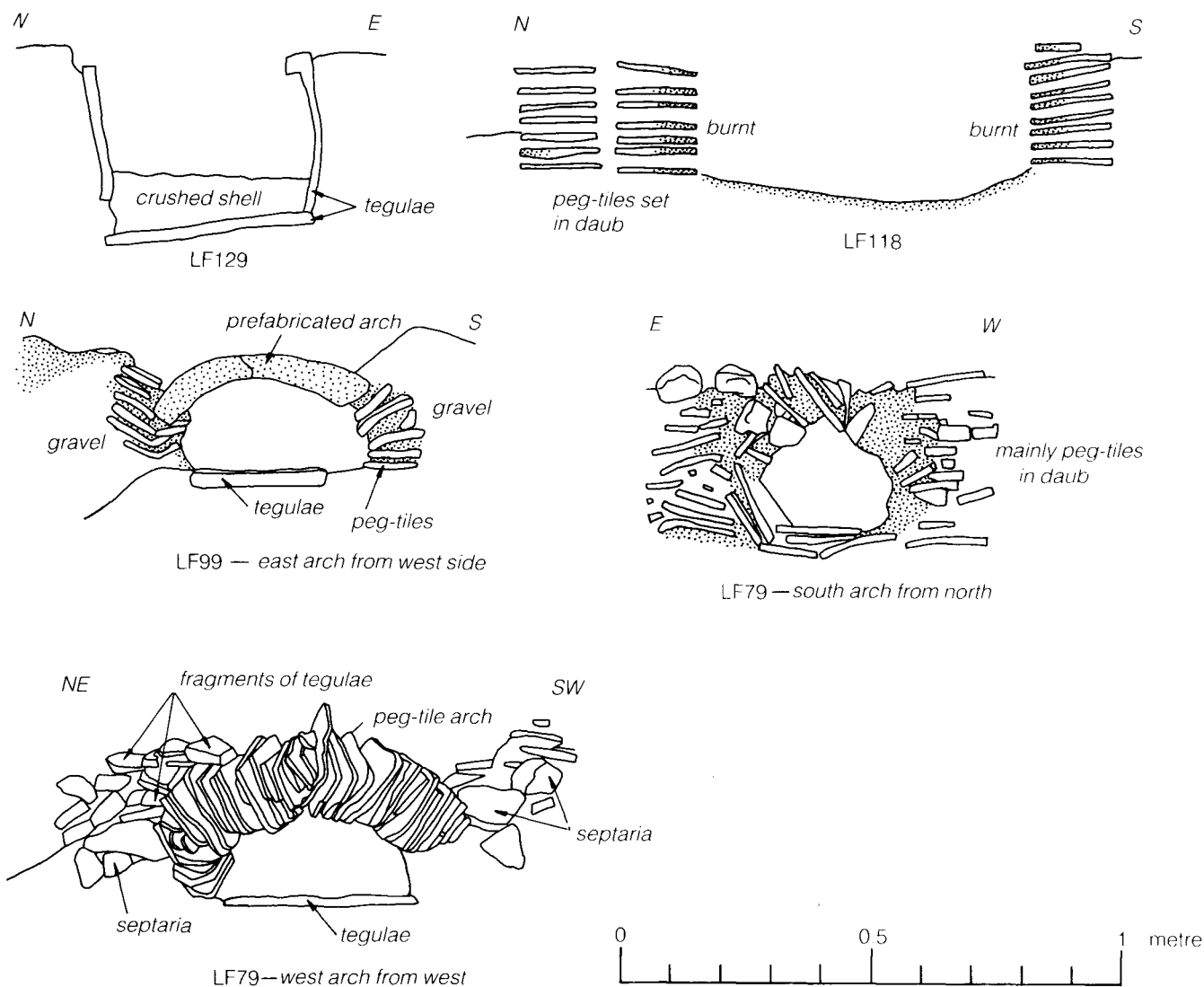


Fig 78 Complex of lime kilns: some structural details. [Pages 87-91]

### Tap slag at the south end of Lion Walk

Substantial quantities of tap slag were found at the south end of Lion Walk mainly in the early medieval robber trenches on Site L and near the bottom of the fill of the 11th-century defensive ditch on Site N (p84). Most of the slag in the ditch occurred in the part of the fill datable to c 1075 (Sx 55, Sheet 6a). Although no features were found which could be linked directly with the production of the slag, the quantities and distribution of this material suggest that the iron working concerned was probably of 11th-century date and took place somewhere near the south end of Lion Walk. That fact that slag was found in the robber trenches implies only that the pieces were disposed of sometime before c 1100-1200. However the circumstances were such that the pottery at the bottom of the ditch was probably not residual but contemporary with the filling of this part of the ditch (CAR 1, 33-40). If correct, then the same is true of the slag.

### Post-Roman streets

[LWC; detail plans Fig 61, Sheet 2b & Fig 72, p85; Sxs 53 & 60, microfiche, & Sx 55, Sheet 6a]

Partial sections were obtained across the streets of Lion Walk (Sx 60) and Eld Lane (Sx 53) and the northern edge of what appeared to have been a gravelled street was found at the south end of Site N (Sx 55 & Fig 72). This was probably laid out when the 11th-century ditch was dug and represents the beginning of Vineyard Street (CAR 1, 53).

The section across Lion Walk was the most informative of these. The earliest metalling sealed post-Roman topsoil and at least one stake hole. The latter was one of several which cut the topsoil. These indicate the site of a post-Roman structure predating the street. The earliest metalling contained fragments of tile all of which were Roman. The absence of peg-tile is consistent with a date before the 13th century. Stratigraphically the earliest

metalling fits well with the stone wall along the frontage of Building 28 and the likely level from which the foundation of this was cut (Sx 60). The Eld Lane section showed that the earliest metalling was probably gravel but no clue was obtained about its date.

### Post-Roman topsoil or 'dark earth'

A thin layer of topsoil (the so-called 'dark earth') was found under Building 28 and under the earliest metalling of the street Lion Walk (*see above*), the maximum depth of the soil being about 0.2 m. Elsewhere it continued to accumulate throughout the medieval and later periods. The topsoil is usually homogeneous in composition and colour (typically 10YR 4/2 dry on the Munsell Color Chart) and is lighter than the Roman cultivated soils where these have been found (typically 10YR 3/3). It seems to have been produced from household debris, decayed plants and leaves, dust, and dispersed building materials. Its homogeneous appearance is almost certainly the result of cultivation combined with the effects of roots and worms. The rate at which the topsoil accumulated appears to have been related to the natural slope. Thus at the High Street, which coincided with a slight ridge along the central axis of the town, the post-Roman topsoil is almost non-existent whereas in places at the south end of Lion Walk it reaches 1.4 m in depth.

During the early medieval period, the topsoil at the south end of Lion Walk seems to have been cultivated. This is shown by the remarkable Section 52 (Fig 79, p 92 & microfiche). When the 12th-century robber trench LF82 was open, part of the side collapsed taking with it a sample of the layers through Room 2 of Building 19. By comparing the layers in the collapsed fragment with the layers still surviving *in situ* in 1972 (Fig 79), it is clear that about 0.4 m of the uppermost Roman layers have been lost since the 12th century. Part of this loss can be explained by the fact that the robber trench was backfilled with soil some of which must have been shovelled up from the site of Room 2. However the degree of erosion was too great for it all to be accounted for in this way. Probably the soil was being cultivated in the 12th or 13th century when it must have been shallow enough to permit the underlying Roman layers to be disturbed by ploughing or digging.

The Period 5/6 town ditch at Balkerne Lane (Sx 65, Sheet 6b) and Lion Walk (Sx 55, Sheet 6a) was also

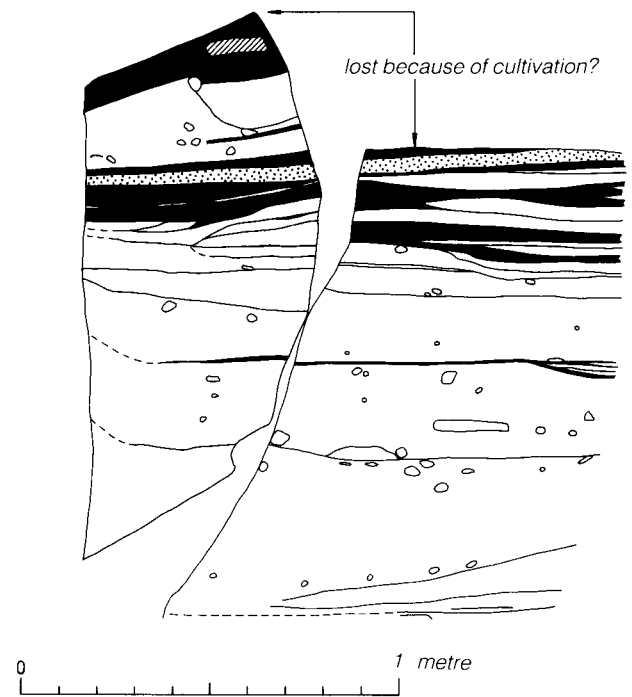


Fig 79 Part of Section 52 illustrating loss of latest Roman levels since the early medieval period. 1:20. [Page 92]

filled with similar soil, the difference being that horizontal or near horizontal tip-lines were visible in it in places. This is important because the ditch preserves the 'dark earth' in its uncultivated form and hence seems to show that a substantial proportion of the material originated as small quantities of dump deposited over many centuries (p 145).

The accumulation of topsoil in the post-Roman period is a familiar feature of urban sites and has been the subject of various careful studies, notably by Dr R Macphail (1981a & b). The latter concluded that there were two types of dark earth, 'one relating to a sparser urban population in London, as an initially dumped artificial garden soil, and the other a deposit concomitant with continued urban refuse disposal as at York' (*id*, 1981a, 327). The evidence concerning the origin of the post-Roman topsoil at Colchester does not fit either explanation easily but seems to lie between the two. Cultivation was an important factor at Colchester but clearly there was never any substantial importation of soil for gardens, otherwise why dispose of the soil in the town ditch?

### Period 1 (c AD 44 to 50/?55)

[BKC; general plan Fig 80, p94; detail plan Fig 81, Sheet 3a]

The principal remains of this period (Figs 80 & 81) consisted of the legionary ditch, the street leading to the west gate of the fortress, the *via sagularis*, and some flimsy buildings which may primarily have been workshops for iron-working. The topsoil appeared to have been stripped over the whole site except perhaps under the main road at the west end (Sx 71, Sheet 6b). A number of human bones were found in the ditch; these are almost certainly remains of people executed at the west gate. The legionary rampart had been completely destroyed by erosion brought about by the digging in Period 6 of a wide defensive town ditch (p15). The site of the west gate was not available for excavation.

Buildings were found on both sides of the street. These have been numbered as Buildings 34-8 on the basis of their relationships to the plot boundaries of the later periods. However the remains, whilst clearly structural in character, are very difficult to rationalise in terms of individual buildings especially since it is not at all certain whether the plot boundaries referred to existed this early. The deposits associated with these structures are characterized by the rapid rate at which they seemed to have accumulated, their high proportion of sand and charcoal, and the almost complete absence of flooring materials. They also contained much slag and other debris including hammer-scale all of which suggest widespread iron-working. A distinctive and rather curious feature of these deposits was the occurrence in them of many ox scapulae. The discovery of a large quantity of butchered animal bone in a pit on Site E (EF325, Fig 85) indicates that these may have been obtained from carcasses butchered in or close by these buildings. A possibility is that the area, being immediately outside a gate, was used as a dumping ground for household and other debris (*see report below*). Whilst this is probably true of the bone, the remains of metal-working were rather too intense and localised to be explicable in this way especially within Building(s) 37. Moreover there are parallels for iron-working immediately outside military establishments (eg Manchester, Jones & Grealey 1974, 67-75).

Building(s) 37 was an encroachment on to the main street. A series of pits was dug along the edge of the legionary ditch at the rear of the building and large quantities of debris from in and around Building(s) 37 were dumped into the ditch and pits. The construction of Building(s) 37 and the activities associated with its use must clearly have taken place late in Period 1 and probably after the evacuation of the fortress by the

legion since presumably no military commander would have allowed his defences to be treated in this way. It follows therefore that if Building(s) 37 post-dated the military occupation then so might all of Buildings 34-8 and the associated iron-working. Consequently at Balkerne Lane the only remains which had been contemporary with the legionary fortress were perhaps the *via sagularis*, the ditch, the main street and the features under it.

### The earliest remains of Period 1

[BKC; general plan Fig 80, p94; detail plan Fig 81, Sheet 3a; large-scale plans Fig 82 & Fig 83, p95]

The earliest features found at Balkerne Lane were some pits on Site E (Fig 81, inset, Sheet 3a) which were perhaps the result of removing bushes or vegetation at the time of the construction of the fortress. The features were sealed by thin gravel metalling only a few centimetres thick (Sxs 66, 69, & 70, microfiche) which formed the southern side of the street leading from the west gate. Over the street was a thin layer of sandy silt into which were cut many wheel ruts (Figs 81 & 82). Also early were some shallow slots (Figs 80, 81, & 83) sealed by Building 46.

### The legionary ditch

[BKC Sites A, B, D, E, K, & P; general plan Fig 80, p94; detail plan Fig 81, Sheet 3a; large-scale plan Fig 85, p97; Sxs 65 & 75, Sheet 6b; Fig 133, p144]

The ditch was located at several points over a distance of 138 m (Fig 81: Sxs 65, 67, & 75; Fig 133: Sx 63). A complete section was obtained at one place only (Site K; Sx 75; pottery dating evidence, Appendix 10) where it was found to be 2.4 m deep and 4.5 m wide. Much of the butt end of the ditch on the south side of the main street was excavated. Here a series of small pits and scoops (Fig 88, p100: EF343, EF346, EF370, & EF371) had been dug along the western edge of the ditch. Those in the northern half of Site E, like the butt end of the ditch itself, had been gradually backfilled with debris scraped up from the floors of Building(s) 37. Further south, but still in Site E, the upper backfill of the ditch was mainly clean yellow sand and lenses of greyish sandy clay. This derived from the demolition of the legionary rampart and corresponds to the sand core and the sandy clay revetment of the ramparts found *in situ* at Lion Walk. Also in this material were faint traces of decayed timbers (Figs 84-5); these must have formed strapping within or under the rampart or else have been parts of some other timber-work associated with it.

FIG 81

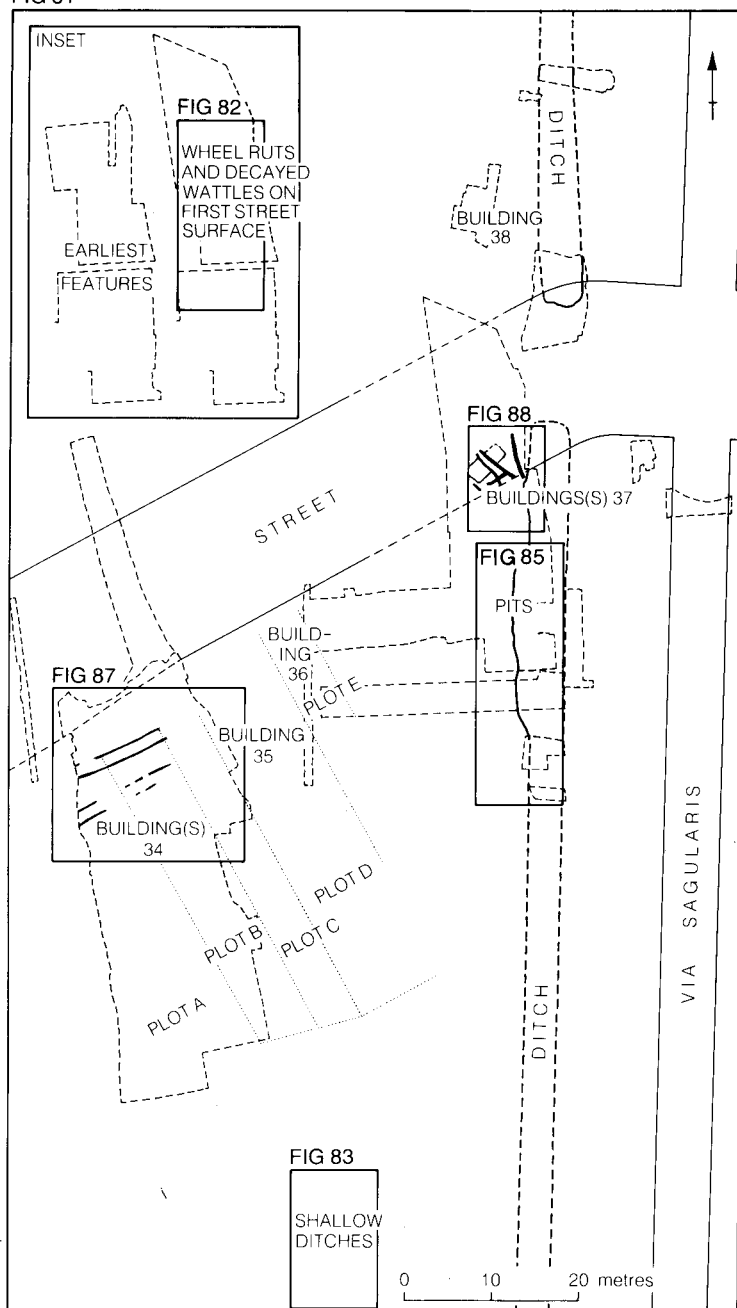


Fig 80 Balcerne Lane Period 1: general plan. [Pages 93-102]

### The *via sagularis*

[BKC Site C; general plan Fig 80, p94; detail plan Fig 81, Sheet 3a]

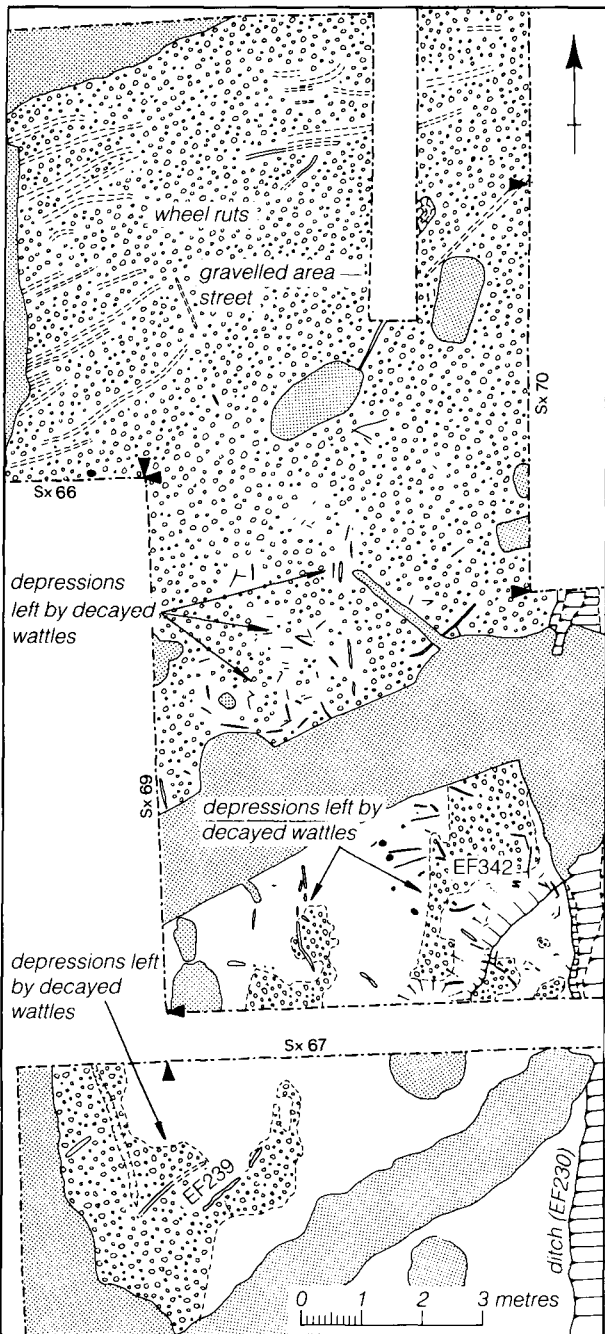
The *via sagularis* was uncovered at one place only (Fig 80-1; Site C; Sx 64, microfiche). It seemed to have been wider here than at Lion Walk (ie 6.5m as opposed to 4.4 m) although the proximity of the west gate may have contributed to a spread of gravel greater in Site C than elsewhere thus giving a false impression of the true width of the street.

### The human remains

[BKC Sites B, E, & P; find spots Fig 85, p97; photographs Fig 86, p98]

The remains of at least six people lay scattered on the bottom and sides of the legionary ditch (Fig 85). They

were in layers of debris associated with the iron-working on Site E and they were mixed with large quantities of animal bone. The human remains consisted of various odd bones, mainly parts of limbs, and six crania, one being represented only by a fragment. One cranium (E1017) bears the mark of a heavy blow inflicted, almost certainly, during execution whilst another (B43) exhibits a depressed fracture near the crown. At least one (E1017), possibly two (P26), of the crania lay close to their mandibles (E1016 & E852 resp) showing that at the time of their deposition there was still sufficient muscular tissue surviving on the heads to hold the bones together. (The mandible E852 was stolen from the site overnight.) The same inference can be drawn about the radius and ulna E854, assuming, as seems likely, that these were from the same arm. These lay together in their correct anatomical position. Probably the human remains



found their way into the ditch by chance and were parts of what presumably had been a large number of corpses or parts of corpses left at the gate of the fortress. The preponderance of skulls hints that it was mainly (but not exclusively) the heads of the victims which were exposed to public view. This also suggests that if removal of the head was not the means of execution then this was carried out after death. The two mandibles, E1016 and E852, and their respective crania were not articulated but were slightly displaced. The explanation for this is not clear. The heads may have been left exposed in the ditch so that further decay took place before the intermittent dumping of debris finally covered them up; more likely perhaps is that they had rotted to the extent that when each of the skulls was dropped into the ditch the force of the impact was sufficient to snap the bones apart.

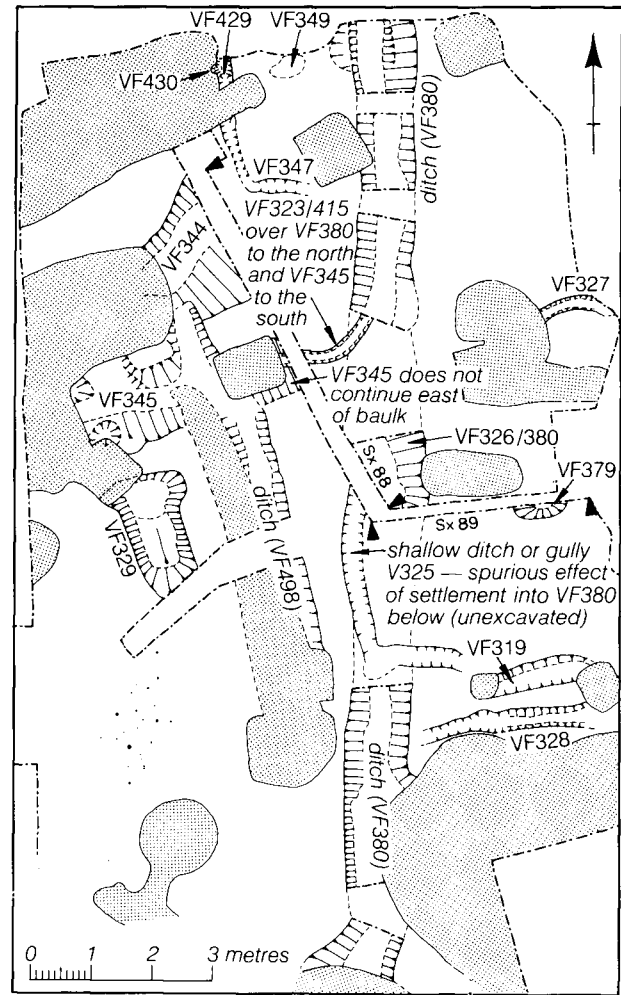


Fig 83 Features which predate Period 2 Building 46 (Balkerne Lane, Site V). [Page 93]

Fig 82 The wheel ruts and decayed wattles of Period 1 on the south side of the main street (Balkerne Lane, Site E). [Page 93]

The presence of part of an arm in the ditch does not necessarily mean that the victims were dismembered since it is conceivable that the corpses had been exposed long enough to begin to disintegrate through decay. However, part of a chopped humerus was found nearby in a Period 2 context. This showed signs of an arm having been removed just below the shoulder if not just before death then presumably shortly afterwards (Fig 86). Perhaps the area around the gate was almost littered with decaying heads and rotting corpses. The context of the bones in the ditch provides only an approximate date before which the executions occurred. Although the dumping of debris and bones into the ditch probably took place after the legion left Colchester and thus fell within the civilian period, the radius and ulna E854, indicating that at least one corpse was probably not 'fresh' when the





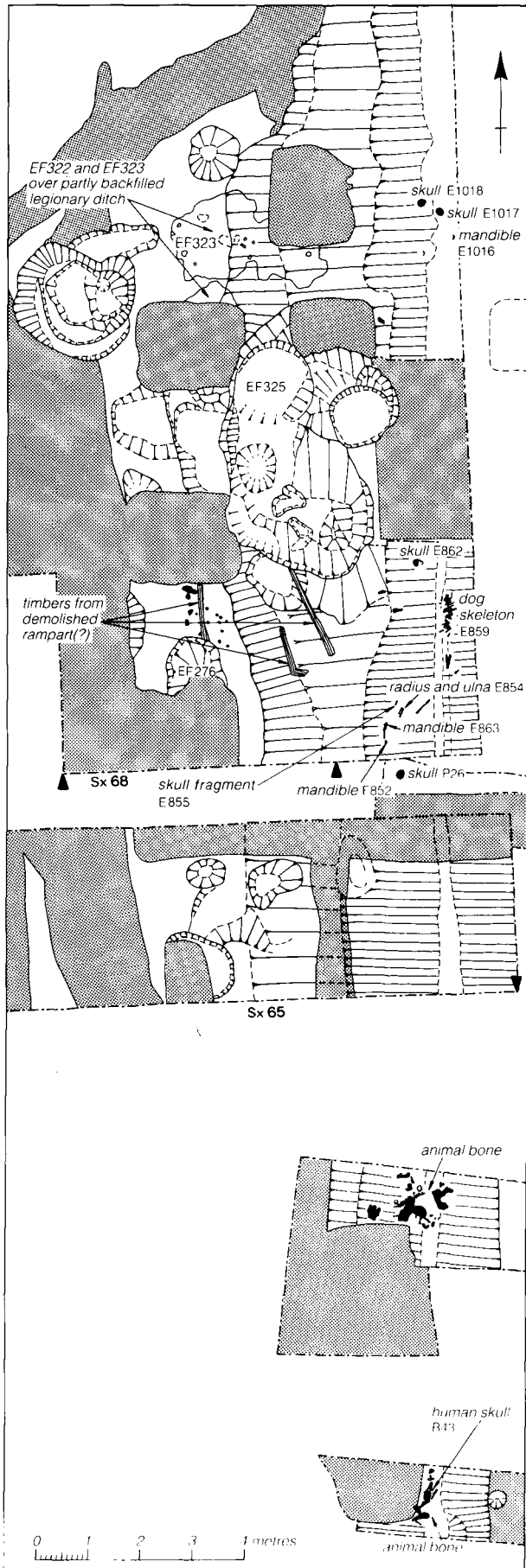


Fig 85 The legionary ditch showing human remains (Balcerne Lane, Site E). 1:125. [Pages 94-8]

ditch was being backfilled, hint that an exclusively military context for the executions is possible. The presence of the bones in the backfill of the ditch and the way in which they were mixed indiscriminately with the remains of animals such as a dog shows the low regard in which these corpses were held by the people who worked in the area and filled in the ditch. Possibly all the remains were of males, the exception being perhaps one cranium (B43). It is unclear whether they were natives or disgraced Roman soldiers. (For human skulls from the Walbrook in London, see Marsh & West 1983.)

### The human remains from the legionary ditch by R Luff

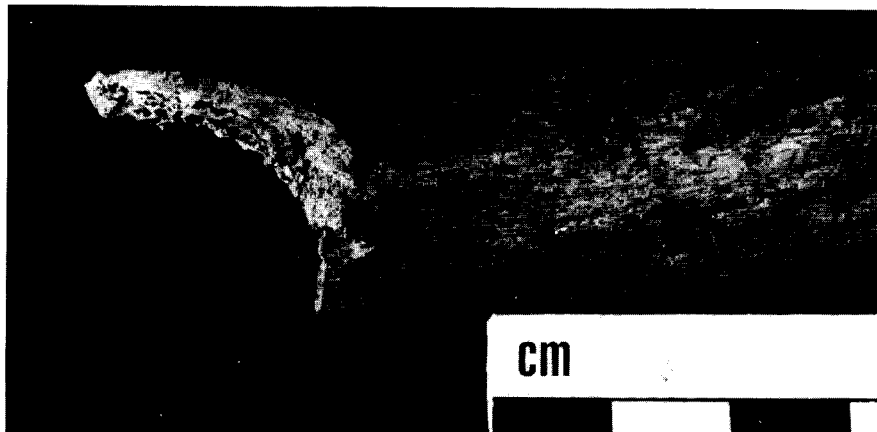
The human remains from the legionary ditch at Balcerne Lane constituted at least six individuals on the basis of the crania (B43, E1017, E1018, E862, E855, & P26). Five reasonably intact crania represented four males (E1017, E1018, E862, & P26) and one ?female (B43). An age range of between 17 and 25 years was exhibited by the crania E1017, E1018, E862, and P26.

One mandible (E1016) was matched to cranium E1017. A heavy blow from a sword or axe had been directed basally into the right lower side of the occipital bone at the nuchal crest. The cut is 35 mm in length and pressure from the weapon had removed a length of bone (Fig 86). There is in the right parietal a possible ante-mortem fracture which has opened due to post-mortem changes. The cranium B43 also shows signs of violence in the form of a small spherical compressed fracture in the frontal bone, with additional spherical lines beyond. The length of the fracture is about 15 mm, and was caused by a blunt instrument, possibly a hammer, sling-stone or pommel of a sword (Fig 86). These injuries showed no signs of healing and probably were the cause of death.

The only other visibly chopped human bone at Balcerne Lane was excavated from Site V, ie an adult humerus with a sword or axe cut through the proximal portion of the shaft (V772). This was found in make-up or floor in a Period 2 context and thus was probably residual from Period 1 (Fig 86).

In addition, twenty-four bone post-cranial fragments were found in the legionary ditch. These can be summarised as follows:

bone	minimum number of individuals
humerus	2
femur	4 (one complete with head illustrating distinct male characteristics)
radius	1
ulna	1
pelvis	3 (all showing definite male characteristics)
tibia	3
sacrum	1
clavicle	1
scapula	1
mandible	3



*Fig 86 The human skulls from the legionary ditch. Above right: E1017; above left: B43; below: humerus.*  
[Pages 94-7]

## Building(s) 34 (Period 1)

[BKC Site T; general plan Fig 80, p94; detail plan Fig 81, Sheet 3a; large-scale detail plan Fig 87, p99]

The remains of Building 34 (Fig 87) consisted of slots, a scatter of stake holes, a patch of gravel and some small pits. The associated debris on the floors and the presence of the stake holes indicate structures of some sort although their number and character are unclear. Four slots were arranged as two pairs of parallel lines 1.5 m apart (TF209/TF210 & TF208/TF229). These were very reminiscent of wheel ruts. They were U-shaped in section and of variable depth, 0.1 m being the maximum. The two southern slots were not so clearly defined as the other two since these petered out in places. In favour

of the wheel-rut interpretation are the following points: i) the widths of both pairs were equal and consistent with the width of a cart or waggon, ii) there was a street adjacent to the slots, iii) the surface into which the slots was cut was soft and sandy and thus very susceptible to rutting, and iv) the regularity of each pair of slots was in contrast to the relationship between the two pairs themselves suggesting that the pairs had not been part of a common structure. Against this interpretation are the following considerations: i) the slots made two distinct well-formed pairs, not the mass of marks of varying clarity more typical of wheel ruts (cf Fig 82), ii) the northern pair stopped with sharp steep ends exactly on the line of the boundary between Plots A/B and C, and iii) the southern slot of the northern pair (TF209) seemed to end at two stake holes (Fig 87).

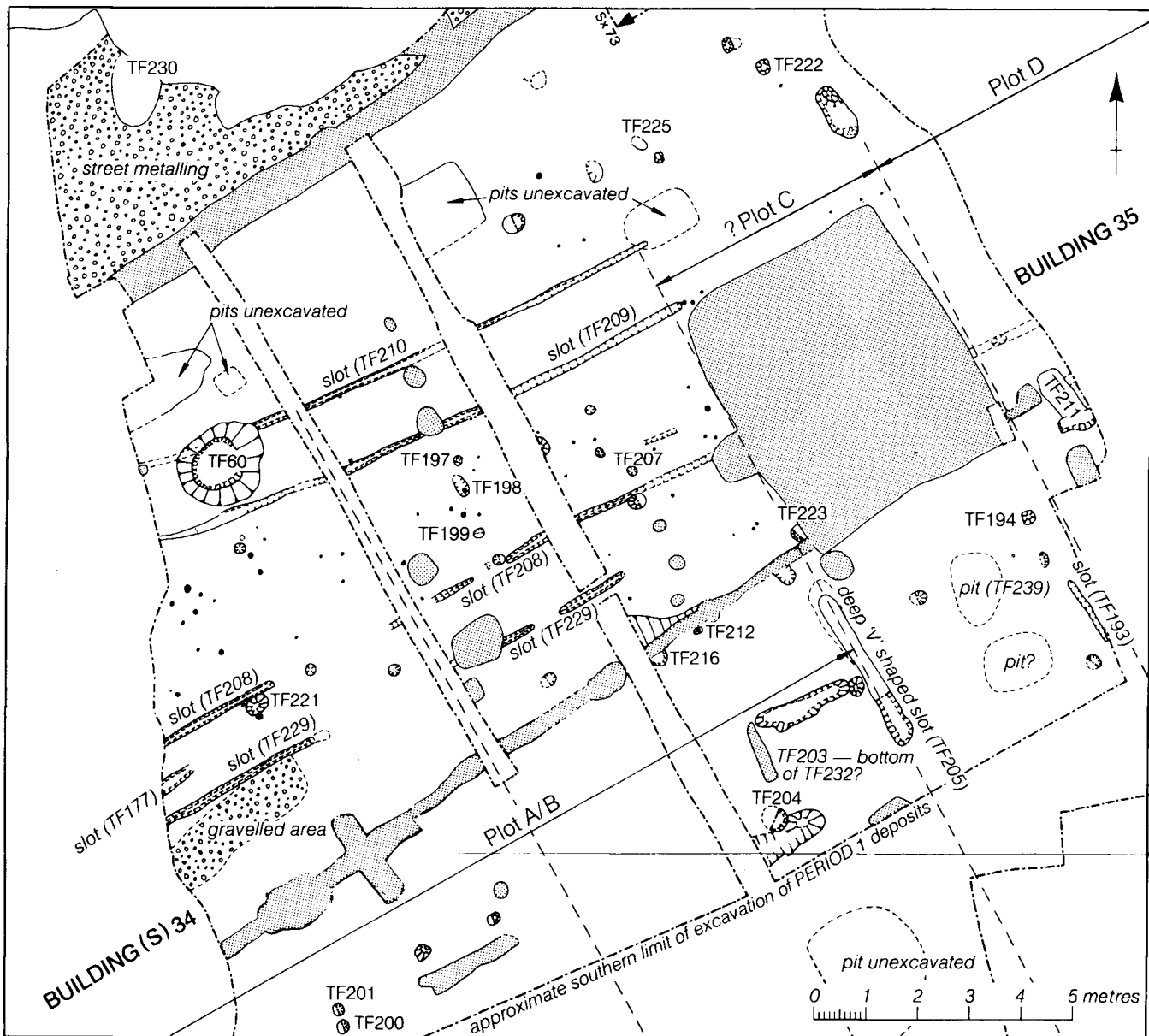


Fig 87 Buildings 34 and 35. 1:125. [Pages 99-101]

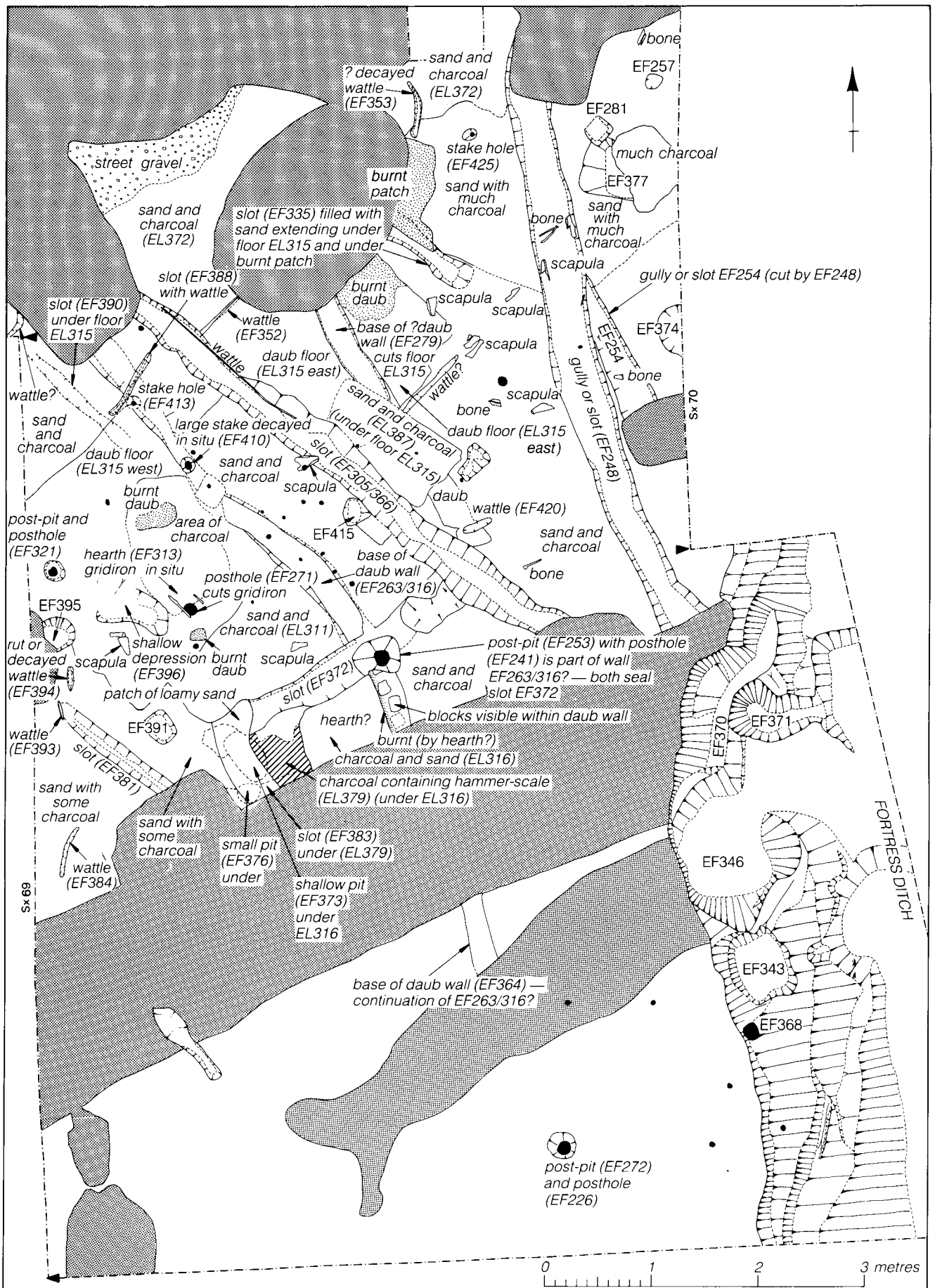


Fig 88 Building(s) 37.1.50. [Pages 93 and 101-102]

## Buildings 35 and 36 (Period 1)

[BKC Sites G & T; general plan Fig 80, p94; detail plan Fig 81, Sheet 3a; large-scale detail plan Fig 87, p99]

Shallow slots (Fig 81; GF107, & GF87), scatters of stake holes and a few small pits indicate within Plots D and E the previous existence of structures similar to Building(s) 34. What these were and how these related, if at all, to the property boundaries of the later periods cannot be established on the basis of the limited excavation of the associated levels.

## Building(s) 37 (Period 1b)

[BKC Site E; general plan Fig 80, p 94; detail plan Fig 81, Sheet 3a; large-scale detail plan Fig 88, p100; interpretative plan Fig 89, p101; plan of metallurgy below building Fig 82, p95]

Many phases of at least one structure were represented here but these are very difficult to disentangle (Figs 80 & 88). From the principal features and layers, the remains can be described in terms of a number of areas most of which seem to represent rooms (Fig 89: Areas 1-11). The most tangible of the remains were several slots for walls (EF263/316, EF305/366, & perhaps EF381 & EF372) and two daub floors (EL315 west & east) which belonged to rooms about 2.0m square (Areas 1 & 2 respectively).

The latest feature, a slot or a gully (EF248), appears to have post-dated the demolition of Building(s) 37. It was probably too wide to have contained the base of a wall and may instead have been a gully which led into the military ditch. The slot cut a similar feature (EF254) which it may thus have replaced although EF254 did not extend to the ditch.

All of the other slots were probably features left after the demolition of narrow walls. The latter were of wattle and daub and were not plastered. The lowest few centimetres of a daub wall were *in situ* at the south end of slot EF263/316. In places within it there were distinct blocks indicating that the wall had contained no wattle framework. Elsewhere there were several examples of decayed horizontal wattles which were clearly in their original positions (ie at the bases of stake-and-wattle walls) showing that walls of this type were also used. When the material covering the floors was removed, a thin patchy metallised surface was exposed. This was the southern side of the first street surface. On this lay a thin layer of sandy silt in which were traces of many decayed wattles (Fig 82). There were also many stake holes which could not be detected until this stage of the excavation because their fill was very similar to the material which overlay the floors of Building(s) 37. The stake holes and wattles were concentrated in the area of Building(s) 37 and therefore almost certainly were associated with it. The wattles were presumably the demolished remains of one or more early phases. The precise nature of the walls of Building(s) 37 is obscure. Like Buildings 44-6 of Period 2, these presumably had stakes as their principal vertical members yet the stake holes formed no clear pattern

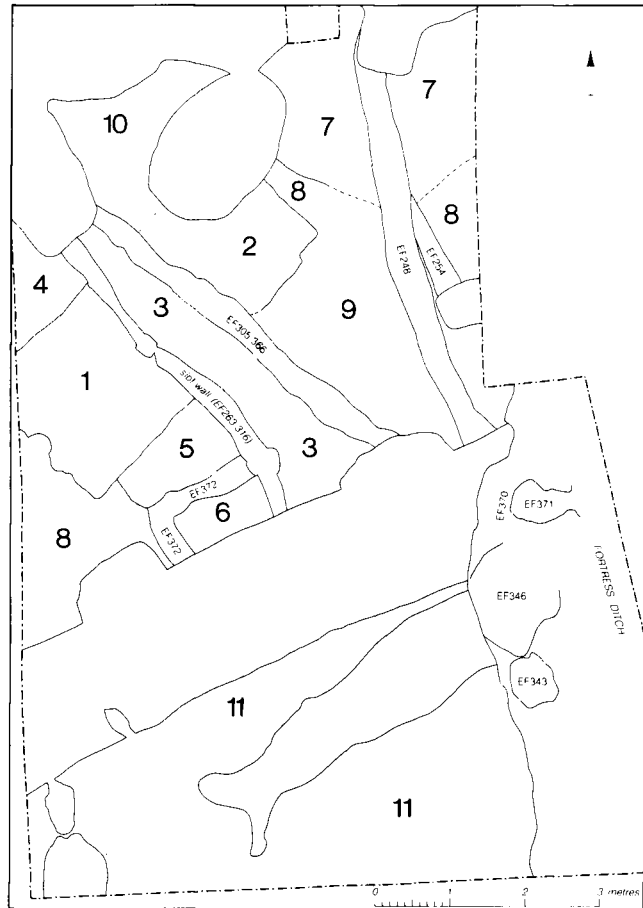


Fig 89 Small-scale plan showing main areas within Building(s) 37. [Pages 100-102]

which could be linked with the walls except possibly for the five holes along EF263/316. Perhaps the stakes barely penetrated the ground so that traces of them were almost entirely removed when the walls were demolished? If true, then the standard of construction was very low compared with other buildings excavated in Colchester.

The slots EF305/366 and EF263/316 showed that there had been a gap of about 0.6m between Areas 1 and 2. This may indicate the presence of two separate buildings although the two floors EL315 (east & west) were so similar to each other in character and in alignment that they were probably part of the same structure in which case the gap must have been a passage connecting the front of the building to the rear. The slots continued north and south beyond the two floors EL315 showing that more rooms must have existed in these positions despite there being few traces of any more walls. On the floor in Area 1 was a hearth defined by a burnt patch of daub, a spread of charcoal and ash and a very decayed grid-iron *in situ* near the centre of the south wall. To the south were two contiguous areas of sand and charcoal (EL311 & EL316) probably representing two very small compartments (Areas 5 & 6). One of these contained a patch of charcoal mixed with sand and hammer-scale and thus may have been the site of a forging hearth. On the north-east side of Area 2 was a well defined spread of sand and gravel which

probably represented the floor of a room (Area 7) neatly in line with Areas 1 and 2. Part of this floor had been burnt and the debris overlying it contained much charcoal and slag indicative of iron-working in the area.

About 10 m south of Building(s) 37 were two hearths (EF322 & EF323) and a few less well defined burnt patches (Fig 85). Although slight in nature, these appeared to be the remains of an unenclosed iron-working site on the edge of the military ditch.

The debris which derived from the iron-working on Site E was examined by Dr H Cleere and can be summarized in terms of context as follows (Fig 89):

Area 1	Furnace lining, forging slag
Area 2	Furnace bottom, forging slag
Area 3	Furnace lining, forging slag
Area 4	Furnace lining
Area 5	Furnace lining, furnace bottom, forging slag
Area 6	Hammer-scale
Area 7	Furnace lining, furnace bottom, forging slag
Area 8	None
Area 9	Furnace lining, furnace bottom, forging slag
Area 10	Furnace lining, forging slag
Area 11	None
EF305/366	None
EF263/316	None
EF372	Furnace bottom
EF248 & EF254	Furnace lining
Fortress ditch	Much furnace bottom, much furnace lining, much forging slag, one sample of tap slag
Pits in fortress ditch	Furnace lining, forging slag
Other Period 1b contexts including ?hearths 10 m south of Building(s) 37	Much furnace lining, much forging slag, some furnace bottom
Contexts later than Period 1b	Much furnace lining, much forging slag, some furnace bottom

## Building 38 (Period 1)

[BKC Site K; general plan Fig 80, p94; detail plan Fig 81, Sheet 3a]

Very little of Building 38 was uncovered (Figs 80-1). However the features which characterized Buildings 34-7 were present, these being layers of sand and charcoal, decayed wattles, stake holes and slag including hammer-scale.

## Period 1 ox scapulae and butchered bone by R Luff

The animal bone deposits of Period 1 at Balkerne Lane mainly consist of butchered cattle bone. Most of the skeletal elements are represented with a slight bias towards the more meat-bearing bones. The bone had been well chopped up with much halving and some quartering of the epiphyses. A large quantity of butchered material was found in a pit, EF325. At least fourteen cattle-beasts were counted and although non-meat-bearing bones occurred, eg skull and mandible fragments, the deposit was characterized

by humeri, radii, femora, and proximal tibiae, ie the more meat-bearing bones.

The deposits of butchered animal bone are not an unusual feature of Site E since similar assemblages are found on many of the Colchester sites. However it is difficult to explain the high percentage of ox scapulae. Previous researchers have declared on the basis of extremely tenuous evidence that Romano-British ox scapulae have been used as shovels or scoops, eg Jackson (1947, 351) with two scapulae from Camulodunum, Noddle (1974, 76) with scapulae from Segontium, and Marples (1974, 123) with thirteen scapulae from Longthorpe. In these cases only the butchery patterns have been observed and not the wear pattern on the blade. Indeed, Rees (1979, 319) stipulates that it is the wear marks along the blade and the back of the bone which must be the deciding factor in interpreting the tool's function. She maintains that she has only found one scapula with polish and a little wear, ie a shaped scapula from Corbridge.

The 149 scapulae from the Site E Period 1 deposits do not give any conclusive evidence that they were ever used as tools. The butchery pattern is uniform across all the Site E periods. In fact if one was to interpret these bones as tools purely on butchery evidence, then it would have to be said that most Romano-British scapulae were utilised as shovels or scoops. Grant concluded that the marks on the Portchester scapulae had resulted from butchery and not tooling (Marples 1974).

The scapula is an important meat-bearing bone. While the bone probably originated from Buildings 34-38, it is possible that some of the Period 1 material including the scapulae emanated as refuse from inside the legionary fortress or early town. The interiors of the Valkenburg and Zwammerdam forts in Holland exhibited large numbers of shoulder blades while the vicus outside the Zwammerdam fort revealed large numbers of well chopped-up long bone (van Mensch & Ijzereef 1977). ■

## Period 2 (AD 50/?55 to 60/1)

[BKC; general plan 90, p103; detail plan Fig 91, Sheet 3b]

The beginning of Period 2 was marked by the destruction of the legionary rampart and the levelling of the workshops (except perhaps on Site K where the situation is unclear), the area ceased to be concerned with iron-making. New buildings were laid out along the street frontages (Figs 90-1). To the south of the main street, Plots A/B, C, D, E, and F were set out (if they did not exist already) and buildings of better quality were erected. At least one of the military buildings on the east side of the *via sagularis* was retained for reuse in the colony (the early building found in 1967 and now recognizable as military; Dunnitt 1967, 66) whilst on the west side, strip houses (Buildings 44 to 46) were laid out so as to extend back westwards over the demolished legionary defences. Two water-mains seem to belong



FIG 91

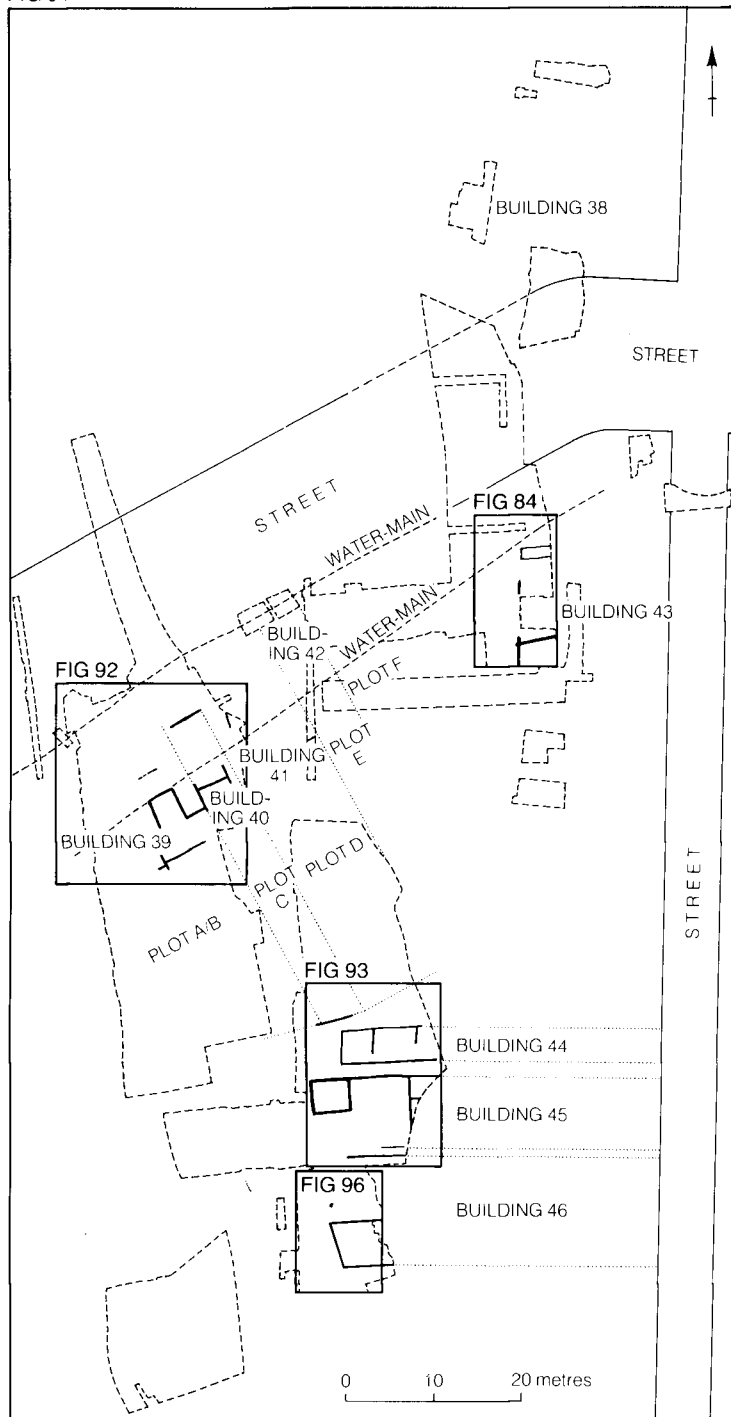


Fig 90 Balcerne Lane Period 2: general plan. [Pages 102-110]

to this period. Of the group eventually to line the south side of the main street (pp 115-7), the deepest and earliest appeared to be TF226/GF193 (Sx 73, microfiche) which apparently continued as GF152/GF205. The context of this is not certain. The trench for the water-main cut the earliest levels yet was clearly very early itself. If not of Period 2, then it was certainly of Period 3. The main EF365/EF467/TF215/GF65 clearly sealed the backfilled legionary ditch and was sealed by the Period 2 floors of Buildings 39-42 (assuming its course across from Sites E to T and G has been correctly deduced (Fig 91)). The main street (Sites E, M & G) and the *via sagularis* (Site C) were resurfaced

at least once during this period. The Boudican revolt brought Period 2 to a close. The burnt levels were not as well preserved or as deep as at some places at Lion Walk. The most substantial destruction deposits were at the western ends of Buildings 44 and 45 on Site J.

### Buildings 39-42 (Plots A/B, C, D, & E; Period 2)

[BKC Sites J, G, & T; general plan Fig 90, p103; detail plans Fig 91, Sheet 3b, & Fig 93, Sheet 4a; large-scale plan Fig 92, p104]

Buildings 39-42 (Figs 90-2) had floors and walls of daub. Little is known about their plans except that they were strip-houses built along a common frontage





oven TF149. The latter survived as a patch of intensely burnt daub with fragments of tile bedded horizontally. Elsewhere the remains seem to point to small rooms about 3 m square.

A substantial part of a collapsed stud-and-wattle wall, discovered in Trial Trench 2 on Site G, belonged to an east-west partition in Building 41. The ground-plate survived *in situ* as charcoal and the positions of the wattles were indicated by voids in the baked daub of the wall. No traces of any studs were found probably because too short a length of wall was exposed. Some charred cereals were also found in remains of this building (Fig 92).

### The charred cereals from Building 41

by P Murphy

Three samples from context T416 were examined. Details are given in Appendix 11 on microfiche. As at Building(s) 45 and 38 (*see below*) wheat grains predominate, but spikelet fragments are not present. In Sample 1281 many of the grains are elongate (L:B around 200) with asymmetrically triangular cross-sections and fairly high T:B ratios. These are identified as emmer, *Triticum dicoccum*. There are a few drop-shaped grains. Shorter grains are also present. Some of these are probably distorted emmer grains, but others are distinctly plump with steeply-placed embryos and are identified as bread wheat, *Triticum aestivum s. l.* Contaminants are few, but include caryopses of hulled barley (*Hordeum vulgare*), *Bromus mollis/secalinus* and indeterminate Gramineae with *Agrostemma githago* seeds.

These samples from Site T are the only samples from Balcerne Lane in which emmer-type grains form the main component, but they are almost identical to an emmer/bread wheat sample from the Cups Hotel site (Find No 950)<sup>1</sup>, even including a similar range of weed 'seeds'. ■

#### Note

1. To be published in a future volume of *CAR*.

### Building 43 (Period 2)

[BKC Site E; general plan Fig 90, p103; detail plan Fig 91, Sheet 3b; large-scale plan Fig 84, p96]

No floors of Building 43 survived (Figs 84, 90, & 91); these and later floors had been destroyed largely as a result of 19th-century terracing. Of the structural features found of this building, none revealed much about its plan. However, Building 43 was aligned north-south so that it must have fronted on to the former *via sagularis* of the fortress. Consequently on Site E it was the rear of the building which was examined. There was no evidence of destruction by fire probably because all the relevant deposits had been stripped off in post-Roman times. The dating for the building comes from its relationship with the Period 3 town ditch which clearly cut it (note slot EF171 in this respect) and the backfilled Period 1 ditch which it clearly sealed. There were several slots which presumably indicated the positions of ground-

plates (EF171 & EF194 and possibly EF146, EF147, EF193 & EF299). Slots EF171 and EF194 varied between about 0.2 to 0.3 m in depth and the bottoms of both contained small depressions up to 0.15 m deep. These puzzling features are reminiscent of the slightly shallower slots of Building 5 at Lion Walk. Slot EF171 cut slot EF194 indicating two structural phases. The building contained an oven (EF159), which survived as a patch of intensely burnt daub and charcoal, and a large, shallow plank-lined pit or trough (EF355/356). The latter had three joists on the bottom and must have originally been about 0.1 to 0.2 m deep. None of the wood had been burnt but instead survived as very thin, faint, light brown stains.

### Buildings 44-6 (Period 2)

[BKC Sites J & V; general plan Fig 90, p103; detail plan Fig 91, Sheet 3b; large-scale plan Fig 93, Sheet 4a]

The description Buildings 44-6 (Figs 90-1) refers to at least three strip houses. If, as is possible, Buildings 45 and 46 each consisted of a pair of adjacent buildings then the number concerned is five. The buildings were aligned east-west and fronted the former *via sagularis* of the fortress. The walls were almost exclusively of the stake-and-wattle type (Fig 11, p21). These had stakes spaced at 0.15 m intervals. Most of the stakes were small and had been driven into the ground by an average of 0.10 to 0.25 m although there were some substantial stakes which penetrated the ground by up to 0.75 m. The exception was Room 6 of Building 45 which was built of round posts dropped into a single continuous trench. Building 44 and the northern half of Building 45 were extensively burnt during the Boudican revolt. Building 46 and the southern half of Building 45 showed no evidence of the fire although because of their relationship to the Period 3 town ditch these must have been demolished if not at the time of the attack then by the time the ditch was dug shortly afterwards. The general paucity of roof tiles and wall plaster in the debris sealing the remains of the buildings indicates that these were probably thatched and that the walls were not plastered. The buildings were separated by two narrow east-west gravelled alleys. Two other gravelled areas were found, one north of Building 44 and the other to the rear of Building 46; these were probably yards. The internal walls tended to be less sturdily built than the external ones since fewer stakes were used. Where stakes did occur inside, these were often associated with internal features. The walls were strengthened with broken tile in places where internal features butted on to them (ie in Room 3 of Building 45 and in the north-west corner of Room 2 of Building 44).

### Building 44 (Period 2)

[BKC Site J; general plan Fig 90, p103; detail plan Fig 91, Sheet 3b; large-scale plan Fig 93, Sheet 4a; large-scale plans of parts of Building 44 Fig 94, p106, & Fig 95, p107]

Room 1 (Fig 93) was defined on its north side by the limit of its floor; the apparent absence here of any traces of a wall may reflect the difficulty sometimes

experienced in detecting stake holes. Likewise only two stake holes were found on its south side. The position of the west wall was shown by a narrow daub-filled slot which ended with a stake hole. The gap probably indicates a doorway. Room 2 was well defined on its north and south sides by rows of stakes. In the north-west corner of the room were two ovens (JF69 & JF124) and a large pot (JF125) set in the ground on its side presumably for storage purposes (Figs 94-5). South of the ovens was a gap in the adjacent wall which must have been a doorway. Also in Room 2 was a large pit (JF129) 0.25 m deep. Its sides were almost vertical and its bottom was roughly flat. The pit had been open during the revolt and was backfilled with demolition debris.

The large oven (JF124) was of at least two phases (Fig 94). Originally it had a wattle-and-daub superstructure, the stake holes of which were set in a shallow, ill-defined slot which extended around the perimeter of the structure. It was rebuilt and had a new floor reinforced with a layer of broken tiles many

of which sealed the stake holes and the slot of the earlier phase. To the east was a low platform of daub 0.15 m high capped with two large pieces of tile set so that they were level with the floor of the oven and formed the mouth of the structure. One of these tiles sealed a decayed wattle of the earlier phase.

Adjacent to the platform was the large storage jar (JF125; Appendix 8, microfiche); this was set on its side so that the bottom of its mouth was at ground-level. Only the lower side of the pot survived *in situ*.

South of the large oven was another of smaller size (Fig 94; JF69). This had been relined once and like the larger oven survived to a height of 0.15 m. The outer surface had been scorched during the Boudican revolt and inside were found an iron shield boss (CAR 2, 4193) and a *pilum* head (CAR 2, 4196). The boss and the head were on the bottom of the oven and were sealed by post-Boudican destruction debris. Clearly these pieces had been put in the oven before it was destroyed and they must have been scrap since

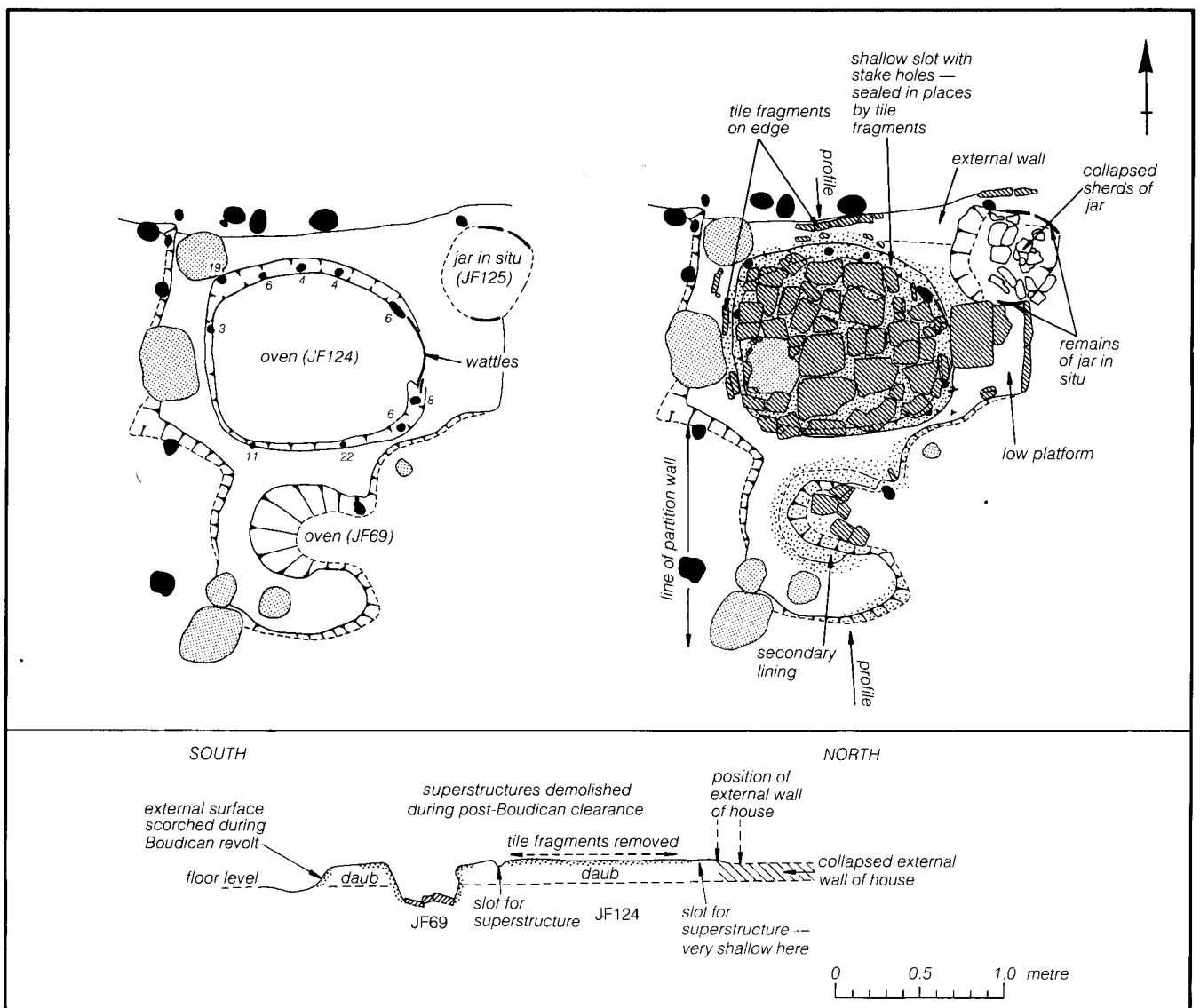


Fig 94 The ovens in Building 44. 1:40. [Pages 106-7]

there would have been no room inside the oven for a complete shield and *pilum*.

Room 3 formed the western end of the building and was very well preserved on the north side where some wattles survived. Near the centre of the east wall was a hearth (JF93) made from a complete *tegula* placed with its flanges upwards. To the east were three substantial stakes arranged in a manner clearly associated with the hearth. These possibly supported a vent in the roof to enable smoke from the hearth to escape.

The base of the northern wall of Building 44 had collapsed northwards as a complete block of daub with parts of its stake-and-wattle frame encased inside. During the collapse there had been no lateral movement east to west so that the remains in the ground corresponded exactly with the stake holes and decayed wattles in the wall. At the east end part of a stake and some of the wattles wrapped round it had been charred during the fire and thus survived as charcoal. In the centre of the wall delicate trowelling revealed faint traces of two unburnt stakes and some wattles adjacent to them. All of these are illustrated in Figure 95. Of the three stakes found, two could be linked with stake holes. Despite a careful search, no corresponding stake hole could be detected for the third stake (the middle one). Perhaps it never penetrated the ground or perhaps the stake hole was too difficult to spot. The west end of the collapsed wall corresponded neatly with the western limit of Room 3 and the north-west corner of Building 44. At the east end, in common with Room 1, the collapsed wall had been destroyed during the widening of the town ditch late in Period 5.

Five metres north of Building 44 (Fig 93) was a short piece of decayed wattle on a north-south orientation suggesting that this had belonged to a building which

had fronted on to the former *via sagularis* of the fortress. However this interpretation is complicated by a line of broken tile and lumps of septaria (JF138) to the east bounding the north side of the gravelled area north of Building 44. The orientation of this material suggests the presence here of a building or other structure fronting on to the main east-west street to the north. It is hard to reconcile the two conclusions unless JF138 belongs to a later phase.

## Building 45 (Period 2)

[BKC Site J; general plan Fig 90, p103; detail plan Fig 91, Sheet 3b; large-scale plan Fig 93, Sheet 4a]

The part uncovered of Building 45 consisted of two ranges of rooms side by side (Fig 93). Six, possibly seven, rooms were identified. These remains could have been parts of two separate strip houses (namely Rooms 1-2 & Rooms 3-6).

Only a small part of Room 1 was available for excavation. This contained the remains of a small oven (JF89) which appeared to have been built against the partition wall JF90. The oven had been cut on its south side by a later feature and continued under the baulk on the east side. All that remained of it was a patch of intensely scorched daub floor covered with lenses of ash; the superstructure had been cleared away. Room 2 was bounded on the east side by the wall JF90. This was probably a stake-and-wattle wall but few stakes were found. On the north and south, it was bounded by similar walls, that on the south being especially clear with its stake holes and a decayed wattle *in situ*. The west side of Room 2 had been destroyed by a complex of later pits.

Room 3 was defined on its east, west, and north sides by lines of stake holes and on its south side by a narrow indistinct daub-filled slot (JF231). The

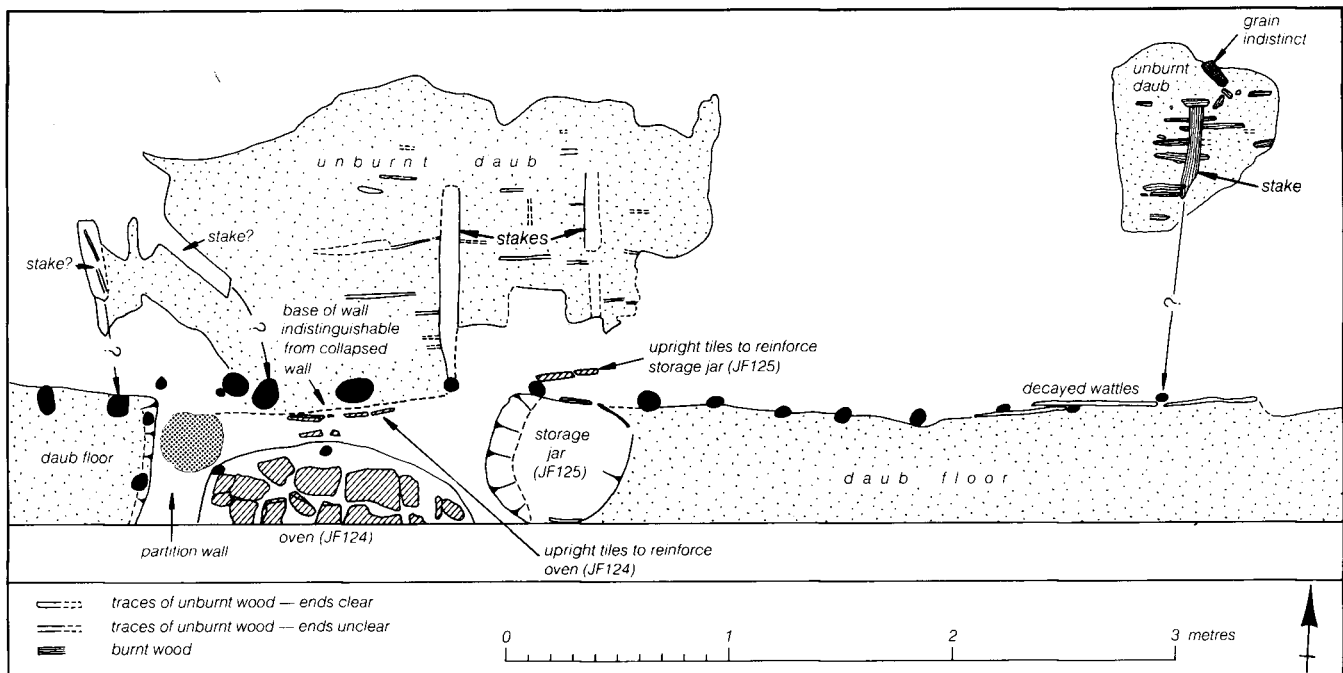


Fig 95 The collapsed wattle-and-stake wall of Building 44. [Page 107]

remains of the west wall of this room lay on the floor and consisted of daub with a large number of fragments of roof tile which had presumably been used as reinforcement. A large stake hole found near the centre of the wall suggested additional strengthening. Room 4 was outlined on its north and east sides by lines of stakes, on its south side by a stake-and-wattle wall (JF233) and on its west side by a change in the colour of the daub used to form the floors. A break in the line of stakes and an additional lens of daub (JL49, not shown here but presumably a repair) suggest the position of a doorway at the eastern end of the north wall (Fig 93). Room 5 was bounded on three sides by stake holes. The south side was later destroyed when some pits were dug.

Structurally Room 6 was different to the others. On three sides its walls were built in a typically military manner where posts were dropped into a trench. The latter was about 0.5 to 0.6 m deep and 0.3 to 0.4 m wide. The posts, spaced on average 0.5 m apart, were round and ranged from 0.12 to 0.20 m in diameter. The wall on the east side did not have a construction trench but was of similar construction to those elsewhere. This suggests that Room 6 was an addition to a building which had previously ended with Room 5. Inside the room were deposits of burnt cereals (see report below) and many fragments of burnt timber. The substantial nature of the walls of this room and the presence of seeds suggests that perhaps this was of two storeys and that grain had been stored in it. The fragments of charred wood point to woodwork of some kind not found elsewhere. In the south-west corner of Room 6 was a patch of gravel; this may indicate the position of a door.

The north and south walls of Room 6 probably contained the same number of posts so that a form of trussed roof seems likely. If the building had been of two storeys, then there was probably also a series of joists at first-floor level linking each pair of opposing posts. Along the length of the construction trench, the spaces between each of the posts varied considerably and did not match up with the equivalent spaces between the posts in the opposite wall. Although apparently more substantial than the rest of Building 45, this lack of symmetry, in conjunction with round- rather than square-section posts, points to a low standard of construction.

To the south of Room 6 was a cluster of small stake holes. Most of these formed two rows suggesting the corner of a structure. One row was east-west, 0.5 m south of the south wall of Room 6, and the other was at right angles to it, near the small pit JF270. The nature of this structure is unclear. The east-west row of stakes and the south wall of Room 6 appear to have formed a passage. Whether this was part of a room within the building or part of a more flimsy outbuilding or other structure cannot be determined.

### **The charred cereals from Building 45, Room 6**

by P Murphy

Full details of the samples examined, extraction methods used and full lists of identifications with

measurements and illustrations are given in Appendix 11 on microfiche. At Site J thirteen samples from JL36 and a further sample from pit JF67 were examined. These consist of fully-processed prime grain with very few impurities. In every sample wheat grains form the predominant component. Frequently they are very fragmentary. This appears to result from their being incompletely carbonised: the interior fractured surfaces are often brownish, and there are translucent pericarp fragments showing the rows of long transverse cells typical of wheat pericarps (Körber-Grohne 1964, 46). Spikelet fragments are absent and identifications must therefore be based on the less reliable criterion of grain morphology. The larger samples of well-preserved grains (eg Sample 3683) include a large proportion of elongate blunt-ended caryopses (mean L:B 193), rather flat (mean T:B 83) with broad ventral surfaces. These are identified as spelt, *Triticum spelta* L. Shorter grains comparable to bread wheat (*Triticum aestivum* s. l.) are also present, together with intermediate forms.

Contaminants are extremely rare and consist almost entirely of large 'weed seeds' which could not have been removed by winnowing and sieving without discarding excessive amounts of the crop itself. They include caryopses of hulled barley (*Hordeum* sp), oats (*Avena* sp) and *Bromus mollis/secalinus*, fruits of *Galium aparine*, seeds of *Agrostemma githago* and, in one sample, hazel-nut shell fragments (*Corylus avellana*). No evidence for insect damage or fungal infestation was observed.

In summary, these samples show that wheats, mainly spelt, were stored in this building as grain rather than spikelets. The admixture of bread wheat-type grains may indicate mixed cropping or alternatively could represent mixing of separate batches of wheat during the destruction of the building. Grain cleaning techniques were very efficient and storage conditions were good. ■

### **Building 46 (Period 2)**

[BKC Sites J & V; general plan Fig 90, p103; detail plan Fig 91, Sheet 3b; large-scale plans Fig 96, p109, & Fig 93, Sheet 4a]

Three discrete areas were discernible in Building 46 (Figs 93 & 96) of which two were rooms and the third was probably external. At the west end of the building was a boundary ditch (VF30) 0.5 m deep. This continued westwards as a large ditch (VF248) 1.9 m deep which, from its position and alignment, seemed to have served as a boundary for the south end of Plot A/B. The remains of Building 46 were difficult to interpret and, like Building 45, it may have been parts of two strip-houses rather than one, the party-wall between the two being VF266.

South of wall VF266 was a room 5.1 m wide. This had a daub floor which had been replaced twice. Some of the stake holes for the west wall were along the east edge of the ditch VF30. In the centre of the room, facing south, was a fine example of a hearth. This sealed some stake holes which belonged to the first phase of the floor. The base of the hearth was formed

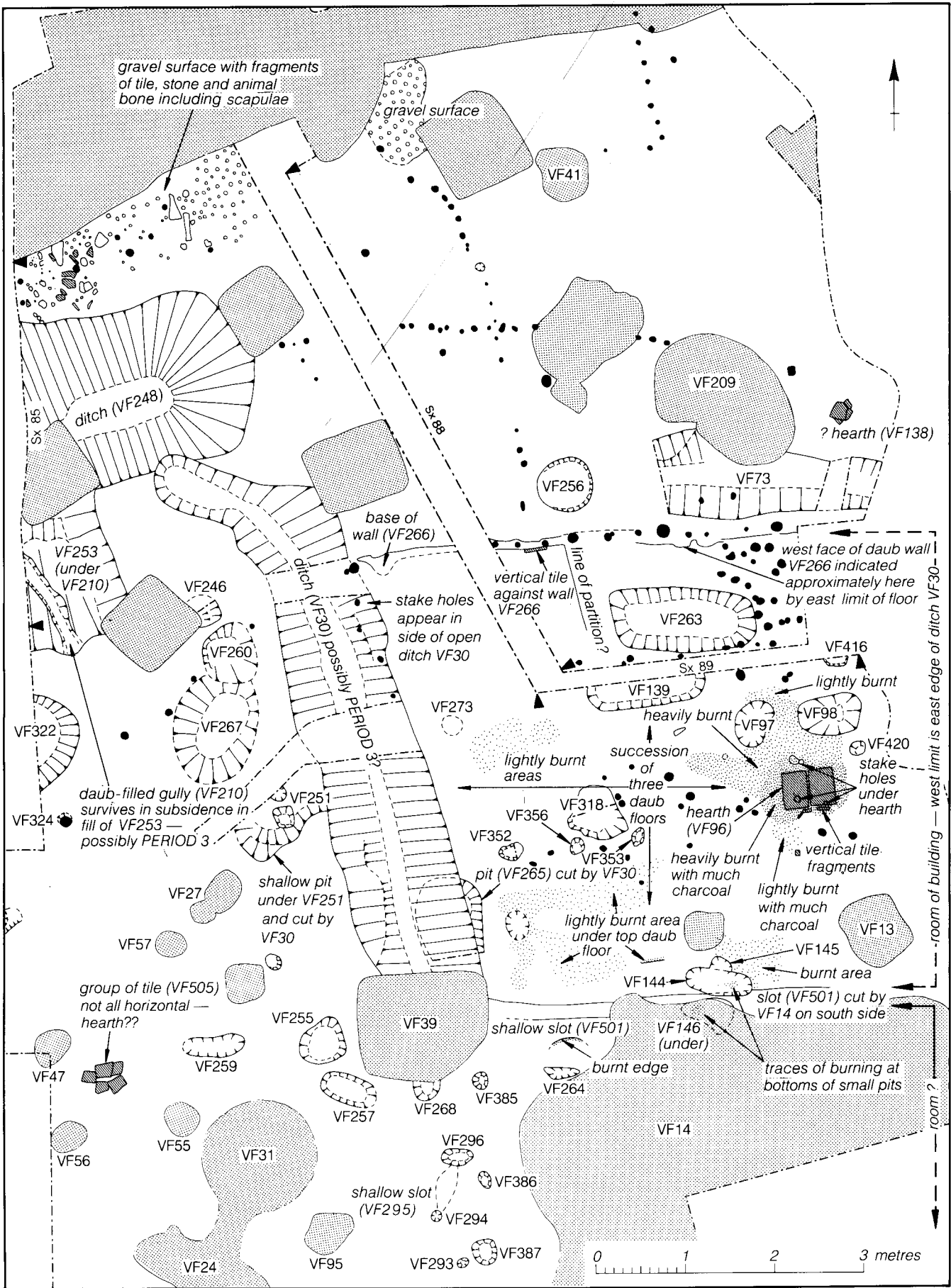


Fig 96 Building 46. 1:60. [Pages 108-110]

by two bricks laid flat. South of these were two fragments of tile set upright into the floor to form a fender. The south side of the tile base was very burnt and decayed and south of it were thin deposits of charcoal and ash. The hearth had a daub superstructure around the other three sides. This had been sheared off at ground level when the building was demolished. The area north of wall VF266 was lightly gravelled; it contained no substantial walls and was crossed by three lines of stake holes. It seemed to have been a small yard very similar in appearance and function to the open area just south of Room 6 in Building 45.

Traces of the north wall of a second room survived as decayed wattles and a line of stake holes along the gravelled alley between Buildings 45 and 46. A second line of stake holes was situated slightly to the south. The latter may have served as a reinforcement for the wall or may have been part of a replacement for it. Traces of a single wattle line continued westwards beyond the stake holes. The absence of stake holes here may reflect the difficulties sometimes experienced in finding them elsewhere. The west limit of the room was not clear although the south side of the gravelled alley west of the wattle line was well defined suggesting the presence of a partition.

### Building 38 (Period 2)

[BKC general Site K: plan Fig 90, p103; detail plan Fig 91, Sheet 3b]

Not enough of the earliest levels were excavated on Site K (Figs 90 & 91) to establish whether Building 38 was replaced before the revolt as seems likely. However in the south-west corner of the site was a burnt layer (KL77) on which lay some burnt grain. This layer was located elsewhere on Site K (as KL31) where it sealed the backfilled Period 1 ditch (KF126). Although no structural features were found, burnt or otherwise, the presence of the grain suggests the existence of a building on the spot in 60/1.

### The charred cereals from Building 38

by P Murphy

Two samples from KL119, two from KF121 and five from KL77 were examined. Details are given on microfiche in Appendix 11. As at Building 45 (see above), these samples consist of fully-processed prime grain, though with marginally more impurities. Spikelet fragments are present, but very rare, and again it proved necessary to rely principally on grain morphology for identification. Spelt-type caryopses predominate, but there is a wide range of grain forms. In Sample 3590, for example, these include slender grains with high L:B ratios (up to 236) and high T:B ratios (>100), which compare with spelt grains harvested at the doughy-ripe stage, as well as short bread wheat-type grains.

Most spikelet forks and glume bases from KF121 and KL77 were referred to *Triticum spelta* on criteria of size and morphology. Layer KL77 also included two lower glumes from terminal spikelets of spelt. Layer

KL119 produced a rachis internode, possibly of spelt, and a sample from KF121 contained a spikelet fork with very slender glumes which could be of either emmer or einkorn (*T dicoccum* or *T monococcum*). Contaminant seeds and remains of other cereals were again rare and consisted almost entirely of large forms: caryopses of six-row hulled barley (*Hordeum vulgare*), oats (*Avena* sp), *Bromus mollis/secalinus* and indeterminate Gramineae, awn fragments of *Avena* sp, seeds of *Agrostemma githago*, *Vicia hirsuta* and *Vicia* sp, nutlets of *Polygonum* cf *aviculare* and hazel nutshell fragments (*Corylus avellana*). ■

### Period 3 (AD 60/1 to c 80)

[BKC; general plan Fig 97, p110; detail plan Fig 98, Sheet 4a]

After the fire, the colony was provided with a large defensive ditch (Fig 7). This cut across the sites of Buildings 44 to 46 with the result that these could not be rebuilt (Figs 97 & 98). The former *via sagularis* of the fortress was replaced by a north-south street 4.5 m wide and laid out 7.0 m plus its own width to the east. The new street has been seen in two trenches dug behind the town wall in 1967 and 1970 by Miss B R K Dunnett. That it was of immediate post-Boudican origin is clear from the published section which shows gravel metalling lying directly on top of the remains of a building destroyed in 60/1 (Dunnett 1971, 66, fig 40). The Period 3 ditch was to the east of the Period 1 ditch. The difference between the ditch

FIG 98

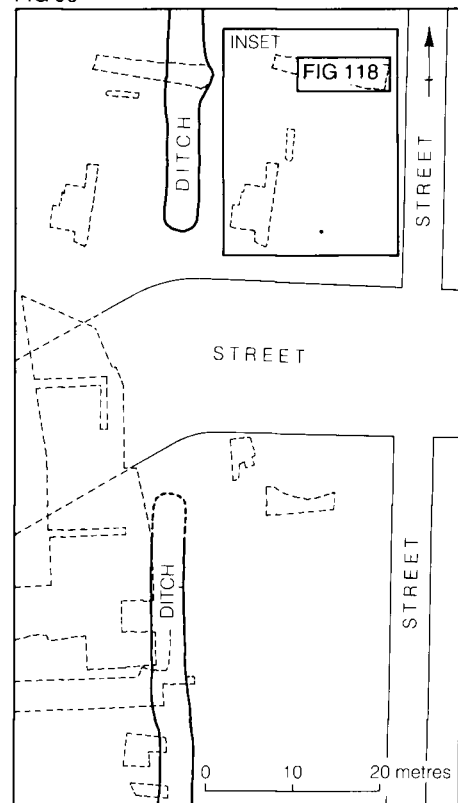


Fig 97 Balcerne Lane Period 3 (east) (AD 60/1-c 80): general plan. [Pages 110-1 & 115]



centre-lines was four metres. (The ditches crossed over down the hill — Site A, Fig 133). A key point in the interpretation of the defensive sequence at Balkerne Lane is the proximity of these two ditches. This must imply that there was an interval of time between the backfilling of one and the digging of the other. Otherwise why destroy a bank and ditch only to construct replacements several metres away? Had the Period 3 ditch followed hard on that of Period 1, then either the Period 1 ditch would have been left and the Period 3 ditch dug some distance to the west as a secondary defensive line or the Period 1 ditch would simply have been cleaned out and retained. Like that of Period 1, no traces of the Period 3 rampart survived and the site of the gate was not available for examination.

### Period 4 (AD c 80 to c 125)

[BKC; general plan Fig 99, p 112; detail plans Fig 100, Sheet 4b, & Fig 101, Sheet 3b]

The start of Period 4 (Figs 99 & 100) was marked by the backfilling of the Period 3 ditch (Sx 75, Sheet 6b). Three public buildings were laid out: a monumental arch, a Romano-Celtic temple (Building 52), and a square structure (Building 53) which was probably a shrine. The arch straddled the main street into the colony and stood on the site of the earlier gates of Periods 1 and 3. The temple and ?shrine were west of the arch and placed on opposite sides of the street with the effect that they sealed the backfilled ditches of Periods 1 and 3.

Strip-houses (Figs 99 & 101) were laid out along the southern frontage of the main east-west street (Buildings 47-50) within the framework of Plots A/B to E. It is not clear if these buildings were constructed in Period 3 or early in Period 4 since they cannot be dated precisely enough. However the houses were probably not built during Period 3 since at this time they would have been outside the town's defences. The walls of these buildings incorporated ground-plates although the exact type of construction employed is not clear. The floors were of daub. More water-mains were laid out along the southern side of the main street. By the end of Period 4 these numbered four.

A timber-framed house (Building 51; Fig 99) was erected over 50 m south of the main east-west street. It sealed a patch of Boudican destruction debris at its east end and thus from this and other stratigraphic considerations was almost certainly of post-Boudican origin. It seems to have been demolished to make way for an ?aqueduct of Period 4 so that the life of the house can be placed within the bracket of Period 3 to early Period 4. The context of this building is puzzling. Neither its east nor its west end was found so that it is not clear what street the building fronted on to. If the house was of Period 3 then it could not have reached the north-south street to the east because of the existence of the Period 3 ditch. If the building was of Period 4 and it did extend to this street, then the house would have been over 60 m long. There was a gravelled area on the north side of the house which

may possibly have been a narrow alley. This changed direction at the east end giving the impression that the street or path ran along the rear of Plots A/B to F and did not continue much further east than the gravel found on Site V. If this was the case, then probably the street extended for some considerable distance westwards to link up with the main street leading into the colony.

A timber structure consisting of two rows of large timber posts was built in Period 4 (Fig 99). It crossed the site of Building 51 and was perhaps an aqueduct.

### Period 5 (AD c 125 to c 300)

[BKC; general plan Fig 102, p 113; detail plans Figs 103 & 104, Sheet 4b]

It was during the first part of the 2nd century that the Roman authorities decided to provide the colony with a stone wall. At Balkerne Lane this was placed probably east of the line of the Period 3 rampart. To preserve the three public buildings, the monumental arch was incorporated in the new gate and the ditch, which everywhere else was to be at the foot of the wall, was swung around the west sides of the temple and shrine to leave them perched on the extra-wide berm thus created. The group of water-mains which otherwise would have been cut by the foundations of the new gate were diverted so as to pass through the southern carriageway of the Period 5 gate. The position of the new ditch in relation to the ?aqueduct meant that the latter had to be demolished before the ditch could be dug.

### Period 6 (AD c 300 to c 400/50)

[BKC; general plan Fig 105, p 114; detail plan Fig 106, Sheet 5a]

The defensive arrangements at Balkerne Lane, whilst successful in preserving important public buildings, could hardly have been regarded as militarily effective. The new gate was designed so that the front elevation of the monumental arch was not obscured, the result being that the functional capabilities of the gate must have been impaired. The new gateway did not have guardrooms which projected beyond the front of the portals; nor was it recessed behind inturns of the town wall in the same manner, for example, as Colchester's north-east gateway (Hull 1958, 36-41). Thus the portals were vulnerable since they could not be adequately protected by soldiers looking down on them from above. Moreover, because of the height of the monumental arch, the new gate may not have had a gallery overhead (pp 121-3). Also, the butt-ends of the new ditch were some distance from the town wall and the view of them from the wall obscured by the temple and ?shrine. These factors must have led to the radical step of widening the ditch and digging it all the way across the carriageways (Figs 105 & 106). Evidence for a bridge was sought but not found, so that it must be assumed that the gateway ceased to be used.

On Site V, at the southern end of the Balkerne Lane site, the remains were found of part of one or more



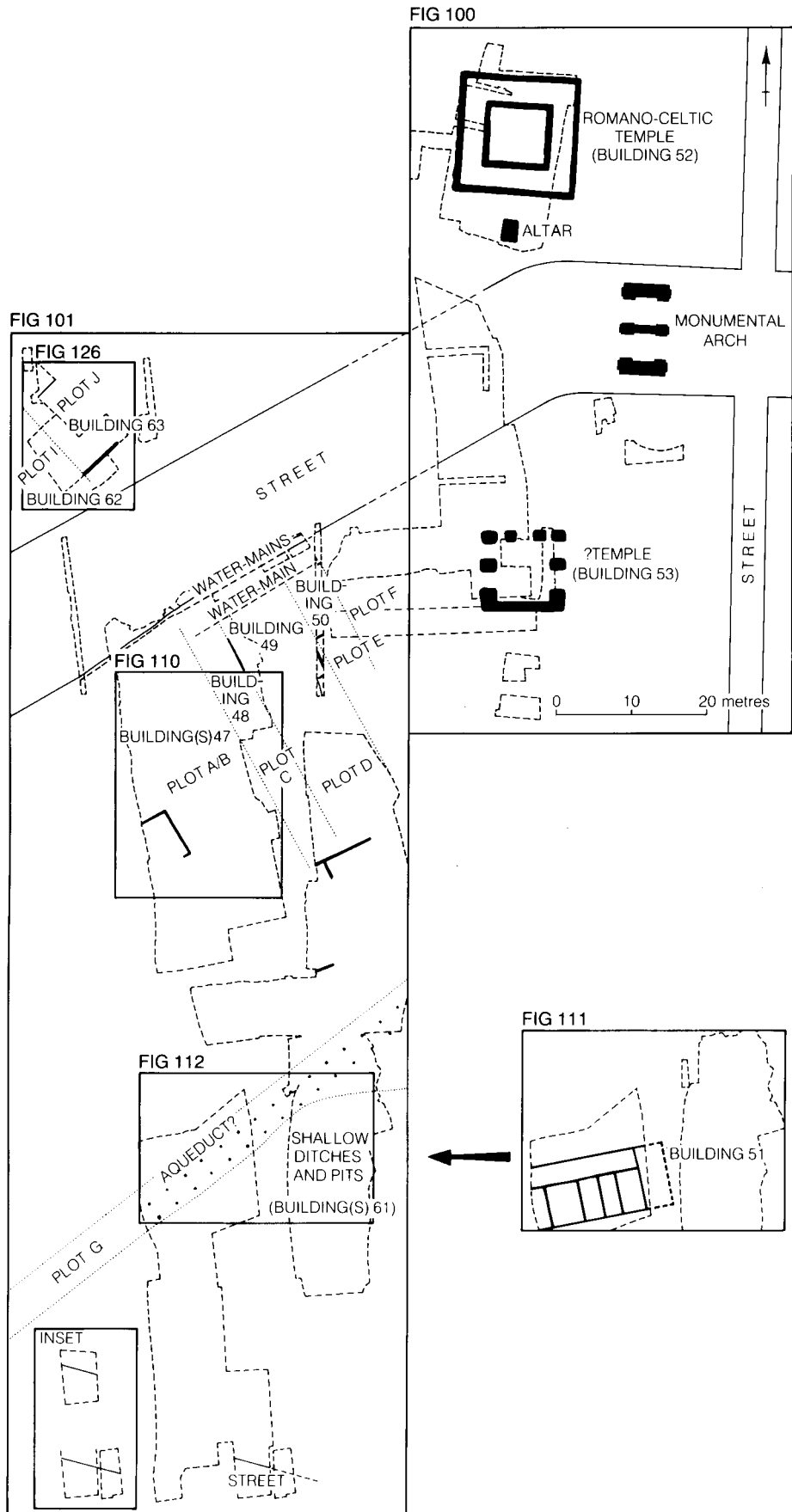


Fig 99 Balcerne Lane Period 4 (AD 80-c 100/25): general plan. [Pages 111, 117-26, 135, & 138]

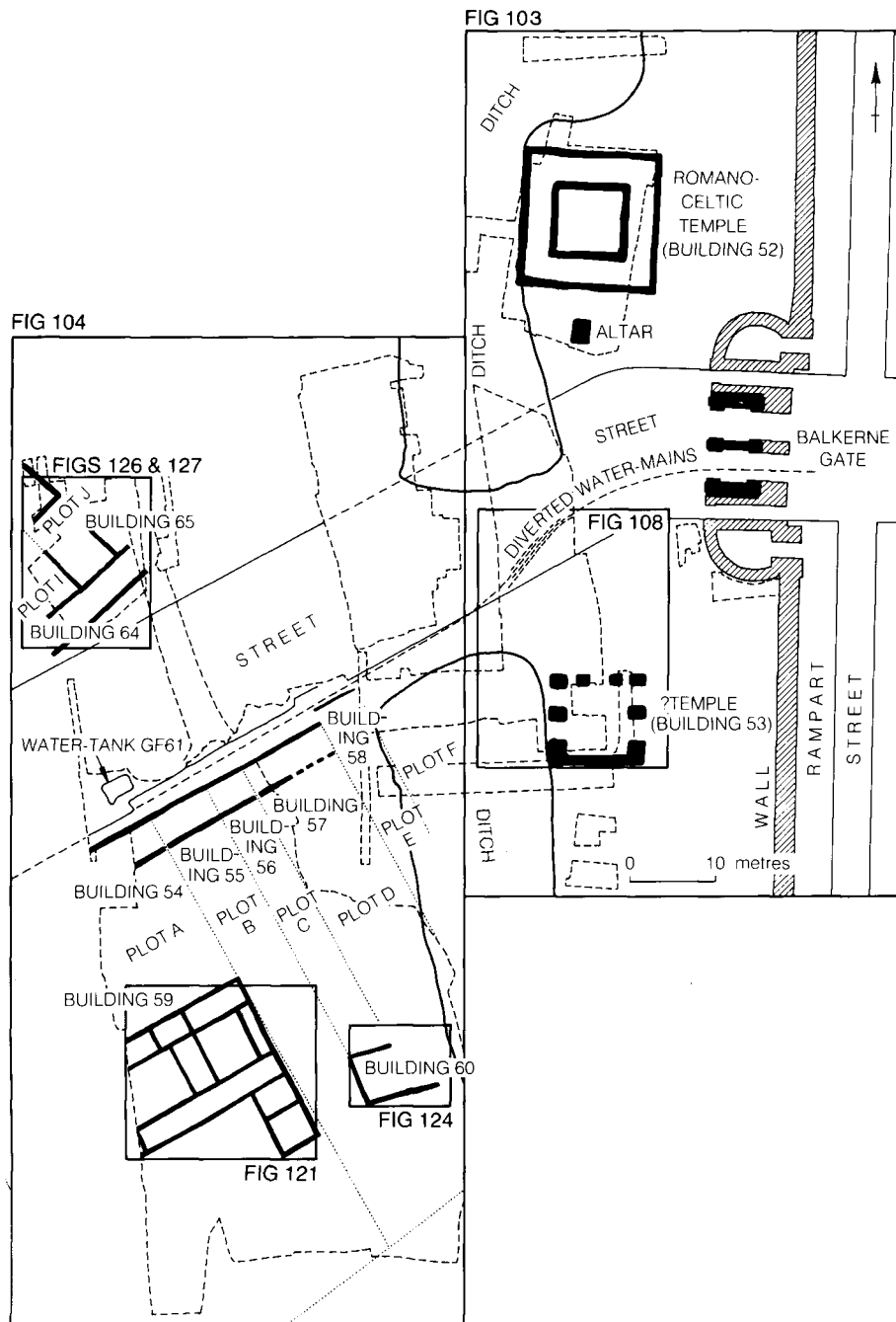


Fig 102 Balcerne Lane Period 5: general plan. [Pages 111, 115, 121-45]

allotments or gardens (Figs 105 & 106). The surface in this area was perfectly preserved by a thick layer of sand and soil which had been dumped over it. This almost certainly came from the adjacent ditch, presumably when it was being widened. Finds in the dumped soil and the underlying cultivated soil point to the earth-moving having occurred *c* 275.

To the west of the ditch the character of the occupation changed markedly. The area was densely packed with buildings until about AD 300 when these were cleared away and the roadside drains and ditches abandoned. Afterwards there was still much activity although the nature of this is uncertain. Many small pits were dug to the north and south of the main street. The function of these is obscure;

some were in rough lines and may have been for fence posts. On the north side of the street, some bone working took place (*CAR 2*, pp 150-3) and debris was being dumped into the ever-subsiding fill of a backfilled cellar (Building 65) until at least the late 4th century at the earliest. The most obvious explanation for the change is that it followed the closing of the street through the gate. This would have had the effect of making the street a cul-de-sac and would have meant that the nearest entrance into the town was Head Gate to the south.

The likely date when the street through the gate was cut off is *c* 300. This is provided indirectly by finds associated with the latest buildings, drains and ditches and the change in the nature of the

FIG 106

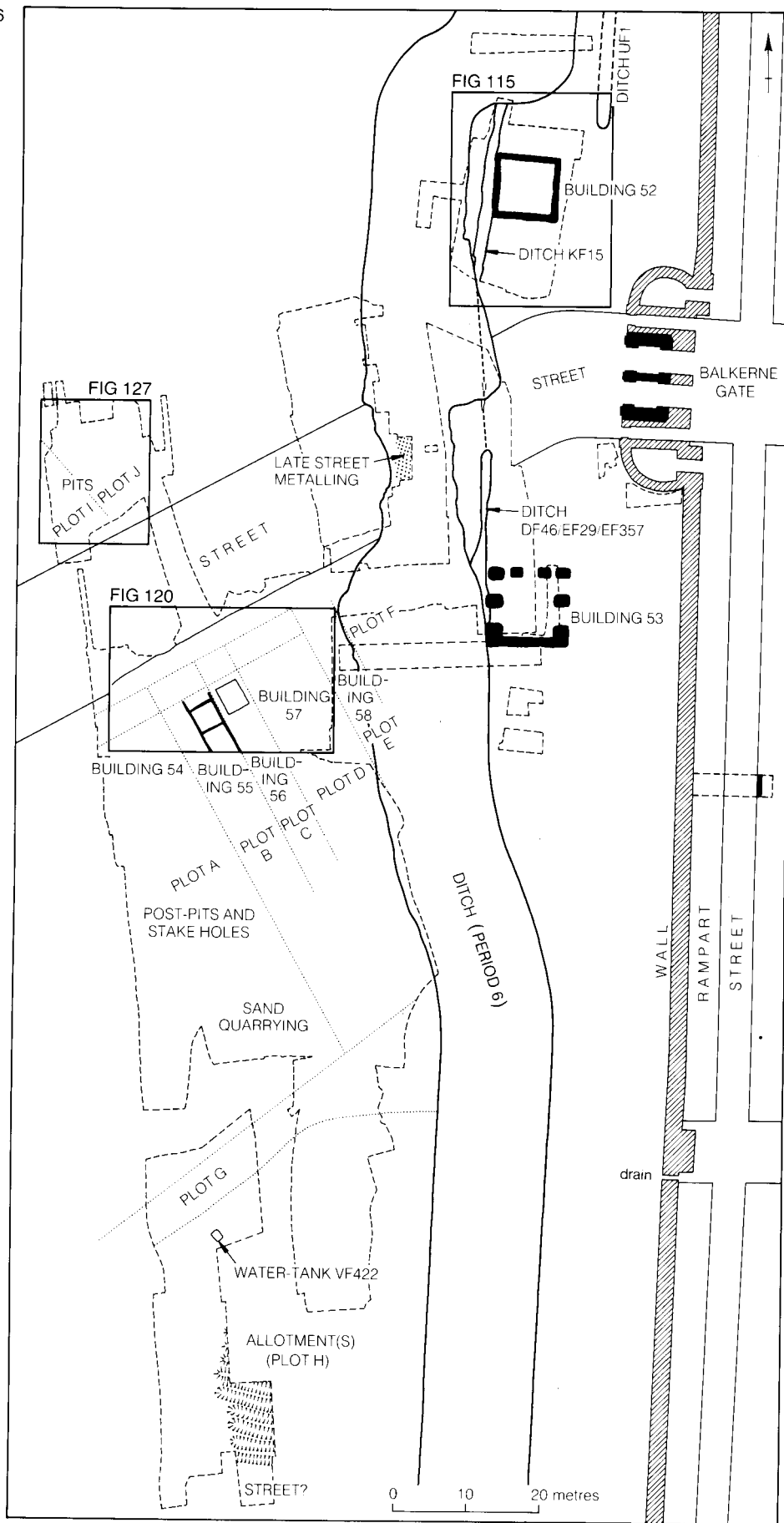


Fig 105 Balcerne Lane Periods 5c and 6: general plan. [Pages 111, 113-7, 121-30, 137-42, 145-6]

occupation west of the defences. The wide ditch seems to have been kept free of silt and debris until the end of the Roman period so that the finds from its fill are of little help in this respect.

Later two additional ditches were dug, one across the street and the other along the eastern edge of the main ditch north of the street. These features seem insignificant in size compared with the main ditch, but a defensive role appears to be the only obvious explanation for their existence. They were left open and therefore were not palisade trenches. When the small ditch was dug across the street, the ambulatory wall of the temple had been demolished and its foundation removed. The *cella* was left intact and consequently may still have been in use. The second ditch stopped short of the site of the north ambulatory wall and therefore may have been dug before the latter's demolition.

Sometime after 335-7 but probably before the end of the Roman period, street metalling was laid over the partly silted up ditch and access into the town via the Balcerne Gate seems to have been restored (p 146).

### An alternative interpretation of Periods 3 to 5

It is conceivable that the town ditch of Period 5 originated as the ditch of Period 3 and that Period 4 as described here did not exist. The idea is attractive since otherwise it seems odd that the town would expand on what turned out to be a short term basis to take in an area of land that may not have technically been within the demarcated city (pp 19-20) Evidence to support this theory is the striking correspondence between the positions of the eastern sides of the Period 3 and 5 ditches. This is in contrast to their relationships with the ditch and *via sagularis* of Period 1. However if this were the case, then the butt ends of the Period 3 ditch could only have been filled in specifically to construct Buildings 52 and 53, an event which seems most unlikely. Moreover Buildings 51 and 61 would have had no north-south street to front on to and there would be no neat explanation for the timing of the erection and destruction of the ?aqueduct.

### The Period 3 ditch

[BKC Sites A, B, D, E, K, & U; general plan Fig 97, p 110; detail plan Fig 98, Sheet 4a; Sx 75, Sheet 6b]

The ditch was located at various points over a distance of 138 m (Figs 97 & 98; Sx 63, microfiche, Sxs 65 & 75, Sheet 6b). It was completely sectioned in one place only where it was found to have been 5.5 m wide and 3.3 m deep (Sx 75). Where observed, the relationship between the ditches of Periods 1 and 3 proved to be very distinct and unambiguous and was that the ditch of Period 3 cut the backfill of the ditch of Period 1. Unfortunately there were no substantial burnt remains clearly of Boudican date which were cut by the Period 3 ditch although on Site K the sequence as set out in Section 75 appears to be

sound. In addition the fact that the western ends of Buildings 44-5 had been destroyed in the fire of 60/1 proves that the Period 3 ditch could not have been of pre-Boudican origin. The relationships on Site K of the Period 3 ditch to the ditch of Period 1 and the later Romano-Celtic temple is central to much of the interpretation of the Balcerne Lane site as a whole. For this reason, the ceramic dating evidence for Site K is outlined in Appendix 10 (microfiche).

### Water-mains (Periods 2, 3, & 4)

[BKC Sites E, G, & T; general plans Fig 90, p103, Fig 99, p112, Fig 102, p113; detail plans Fig 91, Sheet 3b, Fig 101, Sheet 3b, Figs 103 & 104, Sheet 4b; Fig 111, Sheet 4a; large-scale plans Fig 108, p116, & Fig 84, p96; photograph Fig 109, p117; junction-collars Fig 107, p115]

The water-main EF365/EF467/TF215/GF65 of Period 2 (Fig 91) was dug up at the start of Period 3 probably because the course of the Period 3 ditch meant cutting across the line of the main. Some of the pipes which formed the main were removed at this time; the trench dug was partially excavated on Site E (Fig 84; EF251/EF326).

Building 51 was serviced by a water-main (VF439) which passed under some floors and walls of the house (Fig 111).

Three water-mains were laid along the southern side of the main east-west street and a fourth was set out

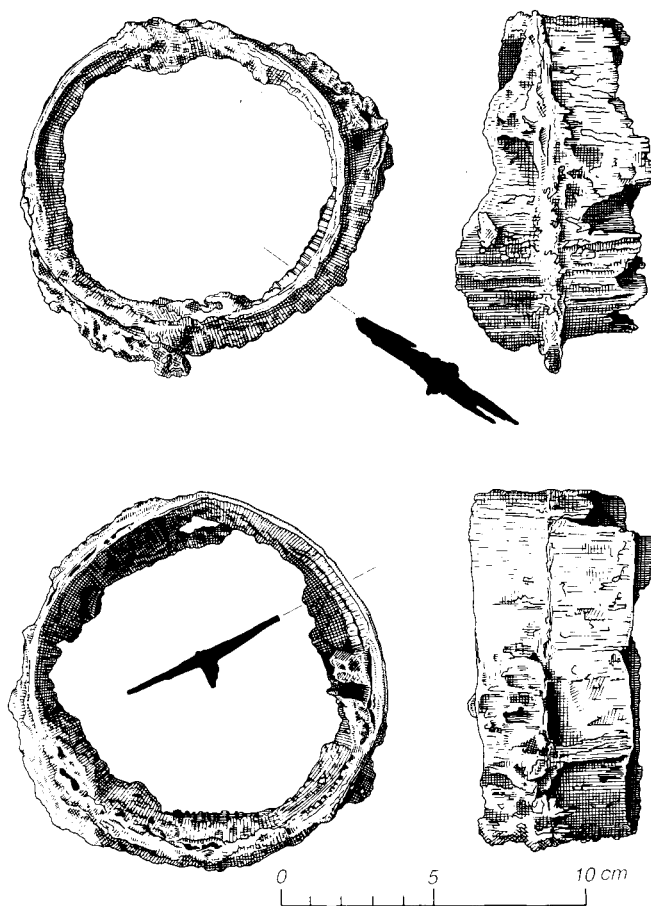


Fig 107 The water-pipe junction collars. [Pages 115-7]

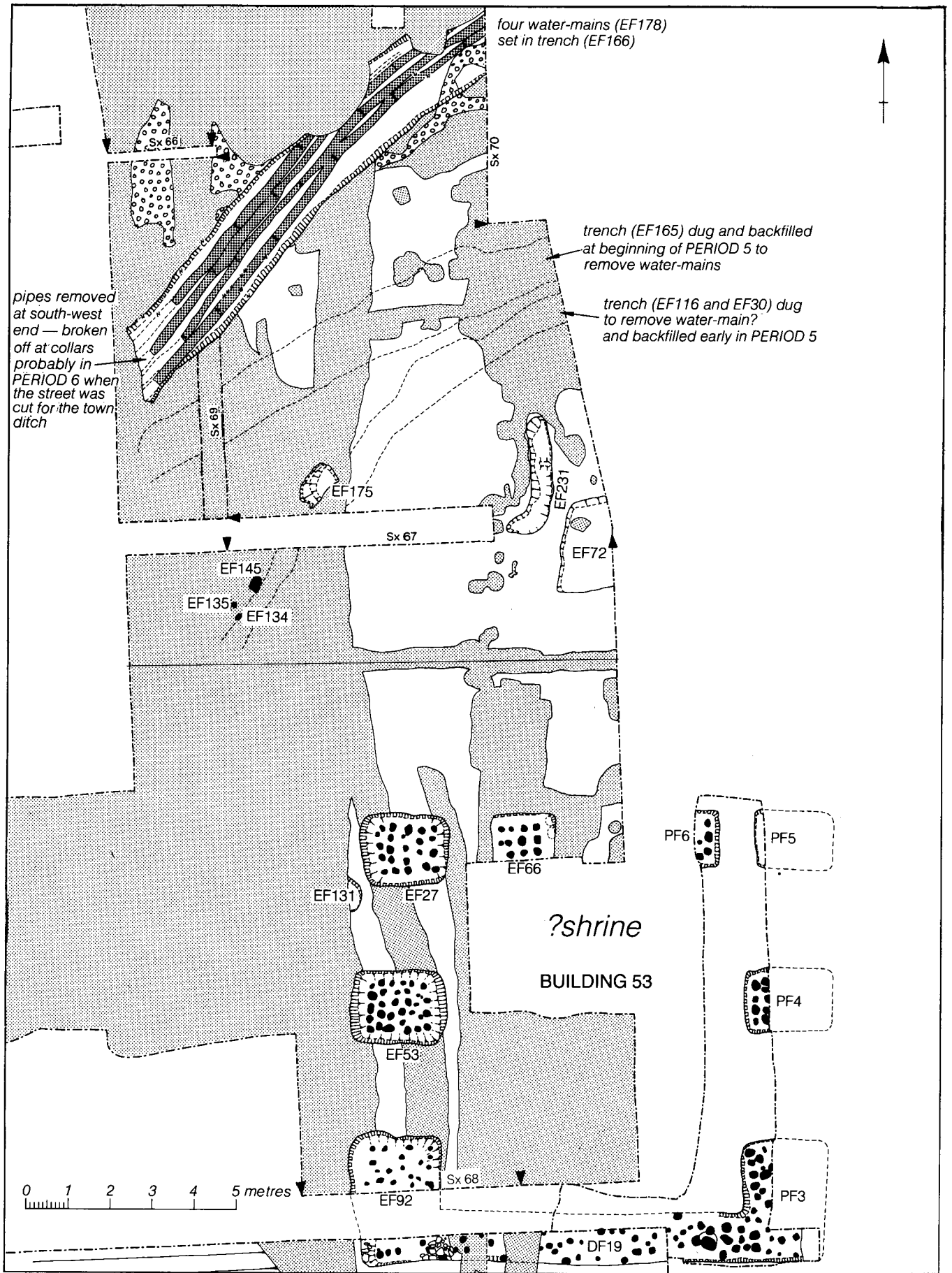


Fig 108 The Period 5 water-pipes and Building 53. 1:125. [Pages 115-7 & 126-7]

parallel to these about 3 m to the south (Figs 99 & 101). It is not certain whether all four were sequential or laid out in one operation. Moreover, from stratigraphic considerations, it is also possible (although less likely) that they were set out in Period 4 rather than Period 3. The number of mains detected diminished in a westerly direction giving the impression that each was servicing a property or a group of properties along the south side of the street. Whether this was the case is hard to establish and certainly no remains of pipes were found inside any of these properties. The water-mains were probably in use until the end of Period 5.

Each main consisted of a series of straight wooden pipes about 0.2 m in diameter and 2.0 to 2.5 m long. These were held together by flat iron bands or 'collars' hammered into the walls of the pipes to form water-tight, pressure-resistant joints. The positions of each pipe showed as a faint light brown stain. Most of the collars were crushed and badly corroded although a few were complete and in their original positions. The two complete collars (Fig 107) have internal diameters of between 100 and 110 mms, and a maximum surviving length of 57 mm. Both the inner and outer surfaces show the characteristic narrow ridge of iron corrosion which formed between the butt ends of the wooden pipes, and both have fragments of iron-impregnated wood (unidentifiable) attached.

When, at the start of Period 5, the water-mains were diverted to pass under the southern portal of the Balcerne Gate (p111), pipes were taken from their original positions in the trench EF165 and perhaps EF116 (*see below*) and transferred to the trench EF166 dug in the street for this purpose (Figs 102, 103, & 108). The system then remained undisturbed until the start of Period 6 when the butt ends of the town ditch were joined together by a short length of deep ditch dug across the street. The mains could no longer be used and the pipes in the area of the new ditch were removed. The wood must have been in good condition despite the pipes being 200 years or more old because each of the mains had broken at a collar. This was shown by the west ends of the pipes in EF166 where the traces of each pipe stopped at a collar (Fig 108). As the ditch was being dug, the pipes must have been hauled out of the side of the ditch after having been snapped off at the collars. Elsewhere, the pipes not affected by this operation were abandoned and left to rot where they lay.

### Trench EF116 (Period 5)

[BKC Site E; detail plans Fig 100 & 103, Sheet 4b; large-scale plan Fig 108, p116]

On Site E a substantial trench (EF116; Figs 100, 103, & 108) seemed to be curved in a series of short straight lengths. The trench was one of the latest features in this part of Site E and it could have been backfilled (and also dug) as late as the 2nd century (Period 5). Several explanations are possible for this feature. The straight sections in the curve seem to point to the presence of either planks of a timber-drain or pipes of a water-main. If the trench were for a



Fig 109 The diverted water-pipes viewed from the west. [Pages 116-7]

drain, then the feature probably led into the town ditch of Period 5 and thus was of a later date than proposed here. Alternatively, if it were a trench for a main, then two interpretations seem likely; either the main supplied the properties closest to the north-south street or the main linked up with the Period 2 main (EF365/EF467/TF215/GF65) to the south and was a diversion for it laid when the Period 3 ditch was dug. The latter implies that the Period 2 main lasted for much longer than supposed above.

### Building(s) 47 and later structures up to c AD 150 (Plot A/B; Periods 3-5a)

[BKC Sites J, T, & V; general plan 99, p112; detail plan Fig 101, Sheet 3b; large-scale plans, Fig 110, p118, Fig 111, Sheet 4a]

Building(s) 47 (Figs 99, 101, & 110) could represent the remains of up to three strip-houses; Plot B if it existed this early may have contained one of these if the slot TF119 was on the line of a party-wall between the other two. Little is known about the plan except that the building (or buildings) extended at least 18 m back from the street frontage. As explained elsewhere (p 132) most of the layers associated with this building were removed by machine. The walls



were of daub with ground-plates although the precise type is obscure (p22). Only the daub floors in the southern half of Site T were exposed. They were burnt and were only about 0.1 to 0.2 m above the level of the Boudican floors. One room could be clearly defined; to the north and south were stumps of daub walls a few centimetres high (TF106 & TF188 resp) and to the east a slot (TF119), left after the removal of a ground-plate during the demolition of the building. The latest pottery associated with the burnt building was Flavian and included a large sherd of *terra sigillata* of form Dragendorff 37. Most important was a coin of 77-9 which lay flat on a burnt floor leaving its impression in the surface.

North of these floors were the lower parts of a large number of small pits and slots. To judge from the pottery, most (perhaps almost all) of these features belonged to buildings which post-dated Building(s) 47 and lasted until *c* 150. The function of the pits is not known but the slots were on the same alignment as the street or at right angles to it and therefore were almost certainly where ground-plates had been located.

Remains of four ovens (Figs 101 & 110) were found of which only one (TF109) can be ascribed with certainty to Building(s) 47. Two were of the common 'key-hole' type. One of these (TF18) cut the other (TF32) and thus was probably a replacement for it. The other two ovens were built of daub and building tiles. One (TF20) was set in the ground and its sides were lined with broken tile. The other (TF109) was surface-built. Its walls and floor were equivalent to the widths of at least one and two tiles respectively and the pattern of scorching suggested that the oven faced west.

The remains of a baby burial (TF73) lay near the frontage of Building(s) 47 (Fig 110; Appendix 1, microfiche). Three votive pots were about 9 m to the south-east (Appendix 8, microfiche).

At the southern end of Plot A/B was a series of decayed wooden floor joists (Fig 111; VF114). These showed as faint brown stains in the layers of make-up and dump of several periods which had survived after having subsided into the upper part of the Period 2 ditch VF248 (Fig 96). The alignment of the timbers and their relationship to the boundary features of other periods make it clear that the timber floor to which these joists belonged must have been inside Plot A/B. Thus it is likely that Building(s) 47 or its successor extended this far back from the street frontage. Most of the remains of the southern end of the Building(s) 47 would presumably have been found in the western extension of Site J but for the ?sand quarrying of Period 6 which seems to have destroyed all trace of it. Evidence of wooden floors of the Roman period is rarely found in Colchester (p23). If they had been commoner than appears, then this example was discovered because the subsidence favoured its survival. Alternatively if wooden floors were indeed uncommon, then this one must have been built to counteract the subsidence, no doubt apparent at the time, into the ditch below.

## Buildings 48-50 (Plots C-E; Periods 3-5a)

[BKC Sites G, J, & T; general plan Fig 99, p112; detail plan Fig 101, Sheet 3b; large-scale plan Fig 110, p118]

Very little is known about these buildings (Figs 99, 101, & 110) except that they were similar in construction and probably plan to Building(s) 47. Floors and other deposits associated with these structures were only examined in detail on Site G in Trial Trench 2 (Sx 72, Sheet 6b). A daub wall (TF182) lay neatly along the boundary between Plots C and D and thus was probably a party-wall between Buildings 48 and 49. In Trial Trench 2, part of a decayed ground-plate (GF49) lay to the south of part of a plinth of mortared tile fragments (GF100). As with Building(s) 47, various shallow slots (GF62, GF37, TF28, & TF31) point to the positions of framed walls. On Site J, a slot (JF241) on the same alignment as Buildings 47 to 50 and therefore probably associated with them, spanned the southern ends of Plots C and D suggesting that, at this stage, these were not separate properties.

A baby had been buried near the east wall of Building 48 (TF58; Fig 110; Appendix 1, microfiche).

## Building 51 (Periods 3-4)

[BKC Site V; general plan Fig 99, p112; detail plan Fig 111, Sheet 4a]

Much of Building 51 (Figs 99 & 111) had been destroyed during the cultivation which took place during later periods (p138). The affected areas of Building 51 included its east end and much of its southern side. However enough survived to show that the building had been a strip-house where a range of rooms was flanked along the north side by a corridor. Its walls and floors were of daub. The positions of the ground-plates were shown by shallow slots a few centimetres deep except at one place by the west section (Sx 84, microfiche) where, unusually, traces of timber survived *in situ*. Here, against the north wall of Room 1, was a small hearth consisting of fragments of building tile set around a complete tile laid flat. Decayed wall plaster *in situ* at the bases of some of the walls indicated that at least the passage and Rooms 3 and 4 had been plastered. On the floor of Room 2 the demolition debris from the surrounding walls contained much plaster proving that this room had been similarly treated. Part of the decorative scheme was reconstructed from the plaster fragments; this proved to be elaborate and contained at least one panel showing gladiatorial combat (pp 147-53). A water-main (VF439) had been laid in the narrow gravelled path or alley to the north. This curved southwards to pass a few centimetres under the ground-plate of the north wall of the house and to continue eastwards under the floors of the passage and Room 6.

## Possible aqueduct (Plot G; Period 4)

[BKC Sites J & V; general plan Fig 99, p112; detail plan Fig 101, Sheet 3b; large-scale plan Fig 112, p120]

A substantial timber structure crossed the site of



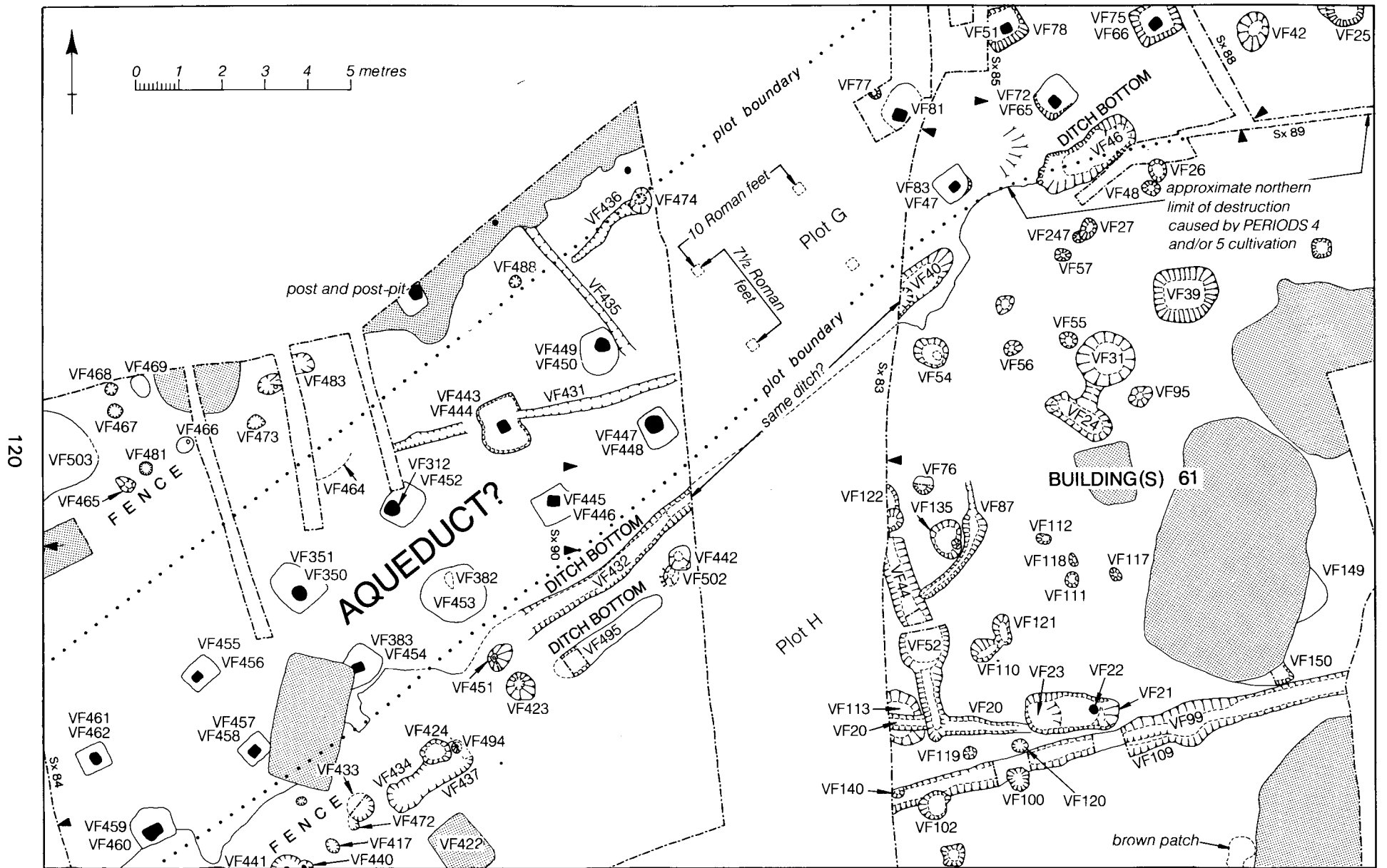


Fig 112 The possible aqueduct. 1:125. [Pages 119-21]

Building 51 in a south-west to north-east direction (Figs 99 & 112). It was traced for a distance of 43 m and appeared to have continued in both directions beyond the limits of the excavation. It was placed immediately to the rear of the plots fronting the London-Colchester street on a strip of land which was about 5 m wide and defined to the north and south by fences and ditches (Plot G). The fences were indicated by irregular rows of small pits (Fig 112) which, like the ditches, were probably of several phases within Periods 4 and 5. The structure consisted of a row of paired posts set out on the basis of 7.5 and 10.0 *pedes monetales* (Fig 112). The posts (as far as could be judged) were about 0.2 m square and had been placed in post-pits which were about 0.6 m deep and aligned with the direction of the structure. The remains give the impression of the building having been a very substantial, well-formed structure probably incorporating good quality carpentry.

The purpose of the building is not clear. In view of the substantial quantities of water implied by the large number of water-mains in the vicinity and taking into account its plan and the relationship of the Balcerne Lane area to the contours of the town (pp26-7), a plausible explanation is that it was an aqueduct. However if this were the case, then its life was short and no replacement for it was found.

The structure belonged entirely to Period 4. Its comparatively brief period of use is neatly proven in Section 85, microfiche. After Building 51 was demolished its site was used as an area for dumping soil, sand, and household debris. This material was

cut by the post-pits of the possible aqueduct. Dumping continued around the base of the posts and over the pits (there was never any floor as such) until, when the structure was dismantled, the posts were either withdrawn from their sockets or (less likely) cut off at ground level. Dumping then continued sealing the post holes as well as the pits. The date of the latest pottery associated with the dump levels appears to be late 1st to early 2nd century. Thus it seems likely that the possible aqueduct existed when there was a clear, unobstructed route into the colony along the rear of the properties fronting the London-Colchester street, ie after the backfilling of the town-ditch of Period 3 and before or until the digging of the ditch of Period 5.

### The Balcerne Gate

[BKC; general plans Fig 99, p 112, Fig 102, p113, Fig 105, p 114; detail plans Fig 100, Sheet 4b, Fig 103, Sheet 4b, Fig 106, Sheet 5a; large-scale plan Fig 113, p121; reconstructions of western elevation Fig 114, p123]

The excavation of the gate was begun by the Morant Club in 1913 under the direction of Dr H Laver and Mr E N Mason, and was resumed in 1917 by Sir Mortimer Wheeler. Three periods were discerned (Wheeler 1921). The first was believed to have been contemporary with the town wall and consisted of a gateway with two principal carriageways, each 17 ft (5.2 m) wide, and two footways, each 6 ft (1.8 m) wide. The second period was equated with a complete rebuilding of the central pier, in conjunction with a reduction in the width of the main carriageways

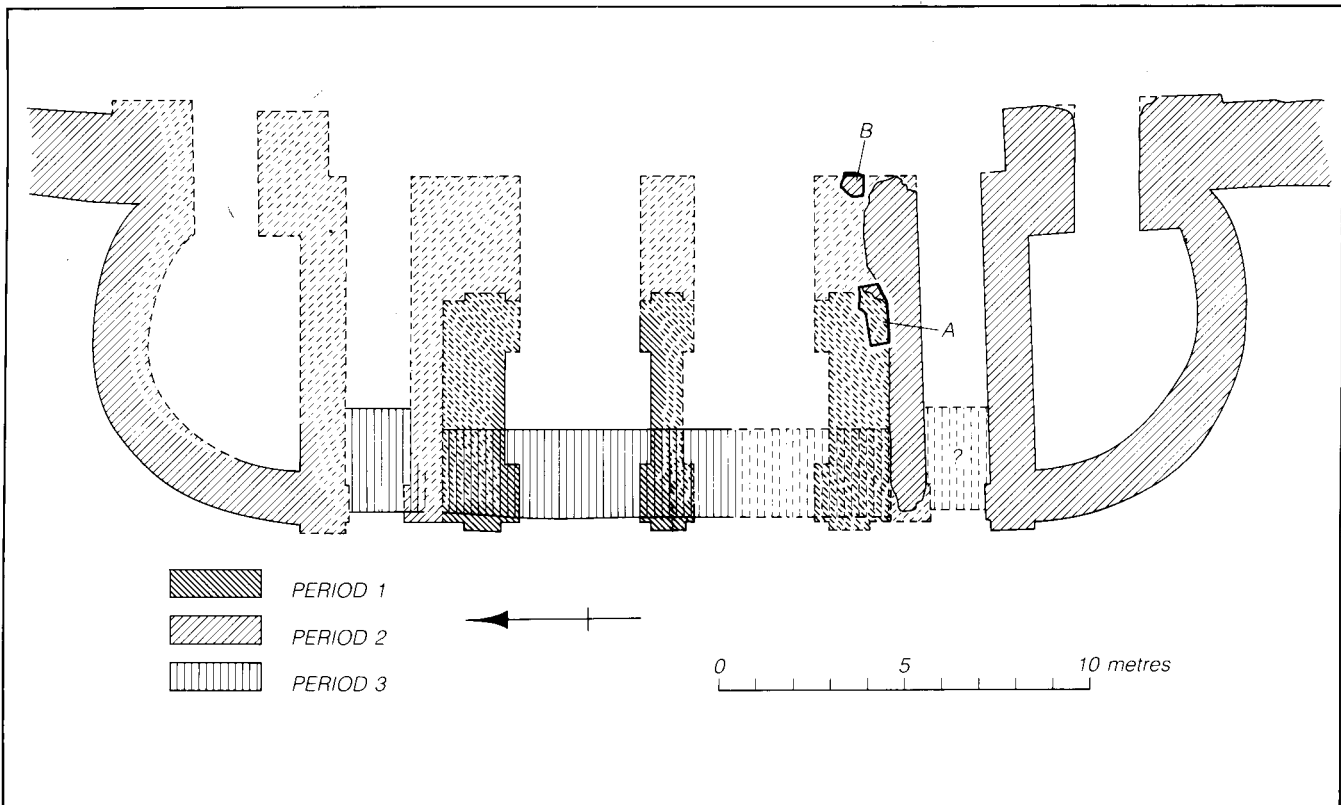


Fig 113 The Balcerne Gate. [Pages 121-3]

achieved by the addition of two or more piers, one over the northern side of the northern carriageway and the other over the southern side of the southern carriageway. The third period was represented by a wall 8.0 to 9.5 ft (2.4 to 2.9 m) thick which extended over the demolished central area of the gateway and blocked the side portals. The first period was dated tentatively to the late 1st or 2nd century, the second to somewhere within the later life of the Roman colony and the third to the Anglo-Saxon period.

When the excavations in the vicinity of Balkerne Lane were about to begin in 1973, the remains of the gate were examined, and it seemed that perhaps Wheeler's first two periods should be reversed. The so-called rebuilding could be interpreted as the remains of an original monumental arch which had two portals and which predated the footways, guardroom and town wall, all of which would have been contemporary. In his report, Wheeler highlighted the extraordinary width of his first-period carriageways, which as he pointed out were considerably wider than the 11 to 13 ft (3.4-4.0 m) normally encountered in Roman gateways (Wheeler 1921, 184). If Wheeler's Period 2 were in reality Period 1, then not only could this peculiarity be dismissed, but, in addition, the combined width of the two main carriageways (25.5 ft; 7.8 m) could be seen to be more in keeping with the width of the streets found within the Roman town (23-5 ft; 7.0-7.5 m).

The northern and southern faces of Wheeler's first-period northern and southern carriageways thicken 22 ft (6.4 m) east of the outer face of the monument. It was postulated that if there had been originally an arch on the site, then its eastern side would probably have lain between these two points since its resulting plan would then have been symmetrical about both its north-south and east-west axes. In 1975, an opportunity arose to test this hypothesis. A small hole was dug in the position where the south-eastern corner of the monumental arch was expected (Fig 113, Area A). The soil removed contained finds of recent date and no part of the arch was discovered. Instead, the northern wall of the southern footway widened northwards, and preserved in the western side of this section of the wall, was the shape of the eastern face of the arch (Crummy 1977, pl 8A). The masonry of the arch was not discovered, presumably because the rear of the arch had been demolished and left in the same state as the masonry at the front. The present surface rises fairly steeply towards the east, so that the top of Area A is approximately 6 ft (1.8 m) above the foundation level of the original arch. Had the hole at Area A been continued downwards, the foundation or lowest courses of wall of the first gateway would probably have been discovered. Area A was not continued further northwards because the wall of the southern footway had been destroyed beyond this point by service trenches. A second hole at Area B (Fig 113) was dug to check the eastern extent of the monument and to confirm the widening of the northern wall of the southern footway as indicated by the excavation of Area A. Although the two holes were of necessity very restricted, they seem to prove convincingly the existence of a

monumental arch which had subsequently been incorporated into the town wall.

The arch must have been built when there were no defences since otherwise it would have coincided with the position of a gate. Thus the arch must have been erected during Periods 2 or 4. Closer dating without further excavation is impossible. In this and earlier reports (mainly Crummy 1977), the Period 4 attribution has been favoured since there can be little doubt that the arch did at least exist in Period 4 even if it had been built earlier. However there is much to support a Period 2 origin. Unlike Period 4, there is an obvious and important historical context for its construction, namely that the arch was built to commemorate the foundation of the colony and presumably also the conquest of south-east Britain. Moreover its presence in Period 2 could explain the otherwise puzzling shift eastwards of the position of the north-south street in Period 3 (p 110). If the arch had been built in Period 2, it would have been exactly on the line of the former *via sagularis* so that when in Period 3 the arch was incorporated in the new gate (as it would have had to be), the street behind the new rampart would need to have been resited eastwards. Further support for this theory comes from the gap between the butt-ends of the Period 3 ditch. This would appear to have been large (30 m) and consistent with the existence at this time of a wide gate. The width of the gate would have been explicable if the arch was contained within it. On the other hand, the fact that the arch lay on the line of the legionary *via sagularis* suggests that it post-dates it, thus favouring a Period 4 origin. If it had been built in Period 2, then it is more likely that the arch would have been erected on the site of the legionary gate rather than several metres to the east. Thus the site of the arch in relation to the gates makes more sense if the arch is seen as a successor to a gate of Period 3.

The Period 5 gate was undertaken as part of the provision of a stone wall for the colony, the date of which is discussed elsewhere (pp 14-5). There are two possible reconstructions for the gate in Period 5, the difference between the two being an overhead gallery (Fig 114).

Although the Phase 3 wall of the Balkerne Gate is generally dismissed as being of a rough and clumsy nature, this may be doing its builders an injustice. The outer faces of the Roman guardrooms retain two areas of refacing made in a manner reminiscent of the Phase 3 wall and there is a short piece of wall on the south side of the monument which is also similar to the Phase 3 work and which may have been the result of a heightening of the Roman town wall next to the gate (Crummy 1977, fig 17). The work of Phase 3 contains tufa which is a rare building material in Colchester and in this case must have derived from the demolition of the monumental arch. Thus Phase 3 may have been a systematic renovation of the town's defences in this area: first the demolition down to the contemporary ground surface of the monumental arch along with part of the Phase 2 northern footway, and then the construction of a thick wall bridging the freshly cleared gap. The adjacent part of the town wall

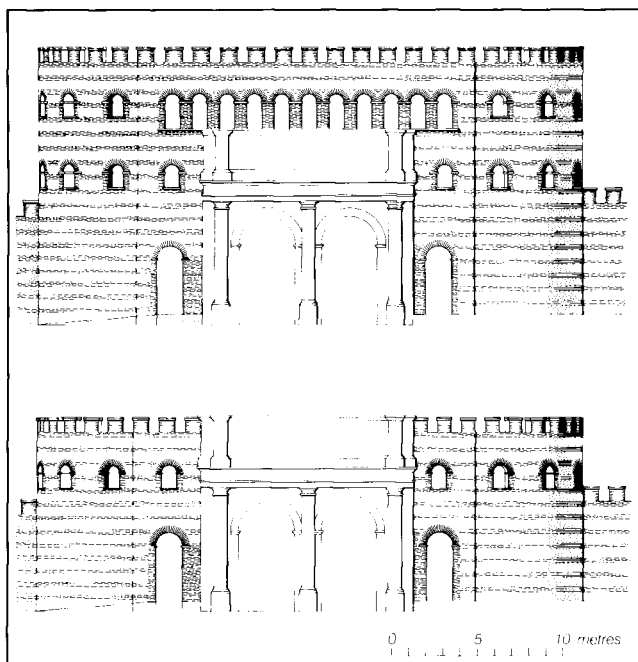


Fig 114 Two possible reconstructions of the Balcerne Gate. [Pages 121-3]

was heightened and parts of the guardrooms were refaced. The new blocking wall may have been bonded into this refacing. The date of the work of Phase 3 must remain conjectural, but the absence of peg-tile suggests a late Anglo-Saxon or Norman date. The rough coursing of the wall is not a technique found in Roman contexts in Colchester although a late Roman date for Phase 3 would neatly fit the defensive sequence revealed during the Balcerne Lane excavations.

### The Romano-Celtic temple (Building 52; Periods 4d, 5, & 6)

[BKC Site K; general plans Fig 99, p112, Fig 102, p113, Fig 105, p114; detail plans Figs 100 & 103, Sheet 4b, Fig 106, Sheet 5a; large-scale plan Fig 115, p124; photograph Fig 116, p125; dimensions of temple Fig 117, p126]

All that survived of the temple were the foundations of the *cella* and robber trenches for the foundations of the ambulatory (Figs 102, 103, 115, & 116). Internally the temple and the *cella* measured almost exactly 50 and 25 *pedes monetales* (14.5 m & 7.3 m) across respectively (Fig 117). The foundations of the ambulatory and the *cella* were of the same dimensions and were 0.8 m wide and 1.15 m deep. The remains of a rectangular plinth of mortared stone and building tile (KF71) lay to the south of the temple. This had probably been a base for an altar. No floor levels survived within the temple, these having been lost in post-Roman times. However around the plinth were some layers of oyster shell and gravel which were contemporary with the temple and which had accumulated on a gravelled yard or court between the temple and the street. The yard probably formed the *temenos* of the temple although no evidence was found for an enclosure wall.

The temple had not been built directly over the backfill of the Period 3 ditch but was separated from it by a sequence of deposits and features which point to a lapse of time between the two events. This sequence can be regarded as being of four phases (Periods 4a to 4d). It is well illustrated in section (Sx 75, Sheet 6b) and can be described as follows. The dating evidence is summarised in Appendix 10 (microfiche).

Period 4a is represented by the backfilling of the Period 3 ditch. The latter contained pottery including much Flavian *terra sigillata*. The pottery, in conjunction with a coin of AD 71-2 from within the upper 0.15 m of silt in the ditch, points to a date of *c* 75-85 or a little later for the levelling of the Period 3 defences.

In Period 4a or 4b, a series of layers was deposited on the site of the backfilled ditch (KL32, KL35, & KL39). The nature of these layers and the time scale involved are obscure. They were sealed in Period 4b by make-up (KL28) on which developed a series of ruts and shallow pockets all orientated north-south (Fig 118, p126). (These are collectively referred to as KF84.) Although there was no gravelled street or path, these features have the appearance of wheel ruts.

The site of the temple overlooked the valley of the river Colne and sloped steeply downwards to the north. To provide a roughly level platform for the temple, a large quantity of make-up was deposited over the area in Period 4c so that at the north end the surface was raised by 0.75 m. The main dump layer (KL26) lay directly on the ruts (KF84) and seems to date to *c* 100. This and the other dumped layers contained late 1st-century pottery and a coin of AD 72-4. They were sealed by a series of 'oyster layers'. The latter predated the Romano-Celtic temple and originated as kitchen waste dumped over a period of time (*see below*). The oyster layers are represented in Section 75 where at the west end they tip downwards in the area later to become the ambulatory. They point to an interval between the main phase of dump and the digging of the foundation trenches in Period 4d. The latest oyster layers were at the southern end of Site K where, although badly damaged by 19th- and 20th-century activities, they indicated continued deposition of household refuse during the 3rd and 4th centuries.

Gravel layers (KL48 & KL58) between the oyster layers at the southern end of Site K appeared to butt against the plinth of the possible altar and were thus contemporary with it. These deposits contained Antonine *terra sigillata* and had been laid down to form a gravelled surface in front of the temple; stratigraphically there was nothing to suggest that these need have been contemporary with the construction of the temple. An oyster layer (KL18) overlapped the eastern edge of the plinth indicating that intermittent tipping of domestic refuse still continued after the demolition of the possible altar.

Narrow trenches were dug on the east side of the *cella* in an attempt to determine the relationship between the foundations and the surviving Roman deposits within the limits of the walls. From these it seemed that the foundations post-dated all the layers

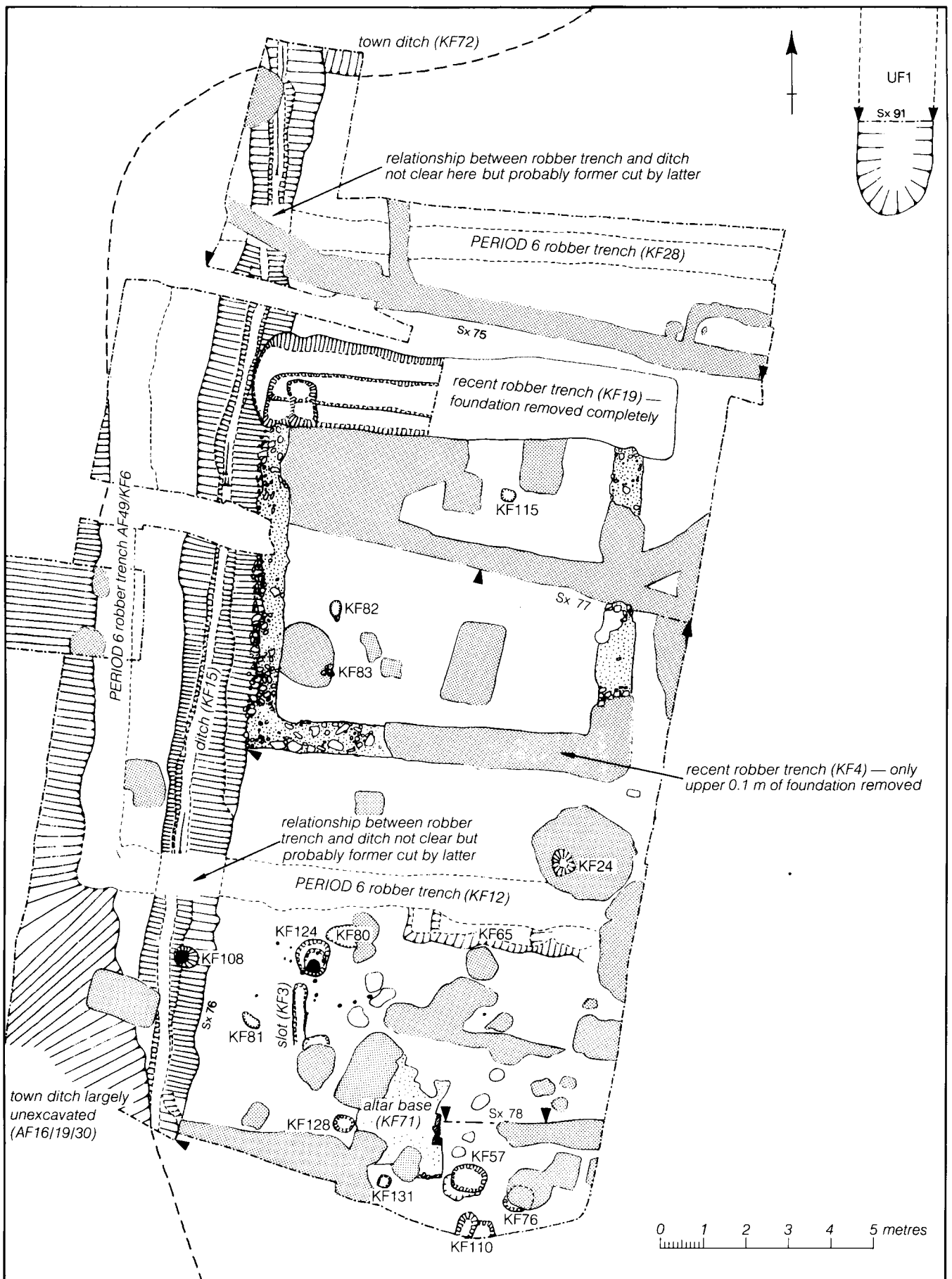


Fig 115 Building 52 (the Romano-Celtic temple), 1:125 [Pages 123-6]



Fig 116 The remains of the Romano-Celtic temple. [Pages 123-6]

examined in this way and that all the floors and occupation associated with the temple had been destroyed in post-Roman times (Sx 77, microfiche). It is possible, although beyond proof, that the floors inside the temple had been at a higher level than the area to the south. The only layer which could be linked with the temple itself was a spread of soft pink mortar (KL54). What this was is obscure; it may have been a construction layer, the base of a floor, or debris left after the demolition of the temple.

During Period 6, the ambulatory was demolished and its foundations were robbed out completely. The date of this event is uncertain but the robber trench (KF12, KF28, & AF49/KF6) contained nothing necessarily later than a coin of AD 341-6 found in it. Fragments of wall plaster, some pink and some white, lay in the backfill of the trench (only in AF49/KF6 and the west

end of KF12) and presumably derived from the temple walls. A narrow trench of 4th- or 5th-century date (EF357/EF65/EF29/KF15; p 145) was dug alongside the western face of the *cella* and apparently across the backfilled robber trench. The foundations of the *cella* survived to the height of the latest surviving Roman layers indicating that the walls of the *cella* were probably left standing at the end of the Roman period. An obvious, though speculative, explanation for the demolition of the ambulatory is that the building was converted to suit Christian use in the mid 4th century or later.

A fragment of a copper-alloy figurine of Mercury (CAR 2, 4266) was found in spoil carted from the Balkerne Lane site after the excavations were completed. The object may indicate a deity to which the Romano-Celtic temple or the possible shrine was dedicated.

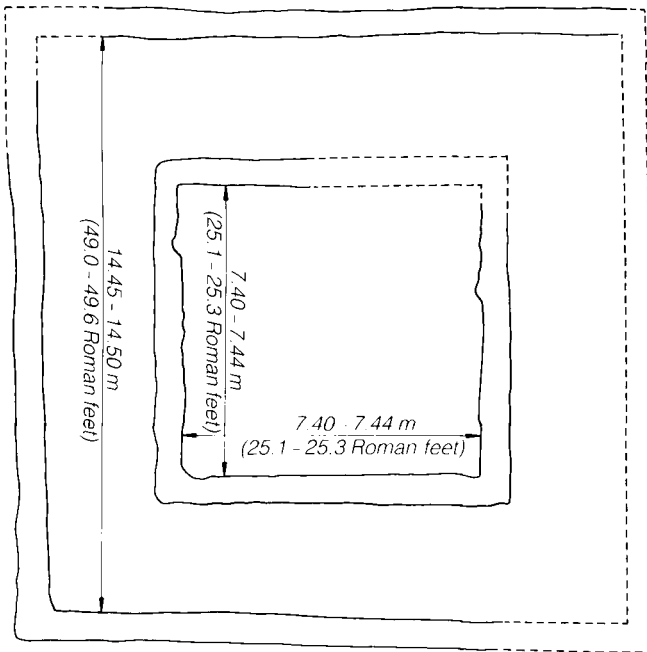


Fig 117 The dimensions of Romano-Celtic temple. [Page 123]

### The possible shrine (Building 53; Periods 4, 5, & 6)

[BKC Sites D, E, & P; general plans Fig 99, p112, Fig 102, p113, Fig 105, p114; detail plans Figs 100 & 103, Sheet 4b, Fig 106, Sheet 5a; large-scale plan Fig 108, p116; photographs of foundations Fig 119, p127]

Building 53 (Figs 99 & 108) lay on the south side of the main street and was directly opposite the Romano-Celtic temple. It was roughly square in plan and measured 10.8 x 11.2 m. The rear wall was solid and the others were on piers perhaps as arcades. The unusual plan and its relationship to the Romano-Celtic temple suggest that the building had been a temple. Its foundations had been thoroughly robbed and no floor levels survived. The foundations of the piers along the sides were 1.25 m deep whereas the two at the front were 0.85 m deep. Wooden piles had

been driven into the natural sand at the bases of the foundation trenches (Fig 119). On average, these were 60-150mm wide and up to 0.75m deep. Although no wood survived, the piles had clearly rotted *in situ* because the holes made by the piles were hollow or filled with soft soil with brown wood-like stains. Also remnants of the foundations survived as thin patches of mortar over the bottoms of some of the foundation trenches. In places these sealed voids left by the decayed piles thus showing that the piles had been undisturbed.

Like the Romano-Celtic temple, the building cut the backfilled ditch of Period 3 but predated the ditch of Period 5. Thus it clearly belonged to Period 4. Demolition of the building occurred in late Roman times although close dating is not possible. In Period 6, the ditch (EF357/EF65/EF29/KF15; p145) was dug to squeeze between the west wall and the eastern edge of the Period 5/6 ditch thus implying the existence of the possible shrine at this stage. The ditch was open in the mid 4th century or later. The foundations of the possible shrine had been thoroughly robbed probably when the building was knocked down. The robber trenches contained only Roman pottery, the latest being mid 3rd century or later in date. A few fragments of masonry were found in the bottom of the Period 5/6 town ditch in Site D. The largest of these was about 0.75 x 0.3 x 0.3 m and consisted of coursed building tiles set in *opus signinum*. This and the other fragments almost certainly derived from the demolition of the building. These lay at the very base of the topsoil which accumulated in the ditch after its abandonment at the end of the Roman period. It is thus likely the possible shrine was demolished in the 5th century at the end of the Roman period.

### The 'oyster layers' (Periods 3-6)

[BKC Sites E & K]

Substantial deposits of oysters up to 0.5 m deep lay to either side of the London-Colchester road just to the west of the site of the Periods 1 and 3 gates (Sx 75

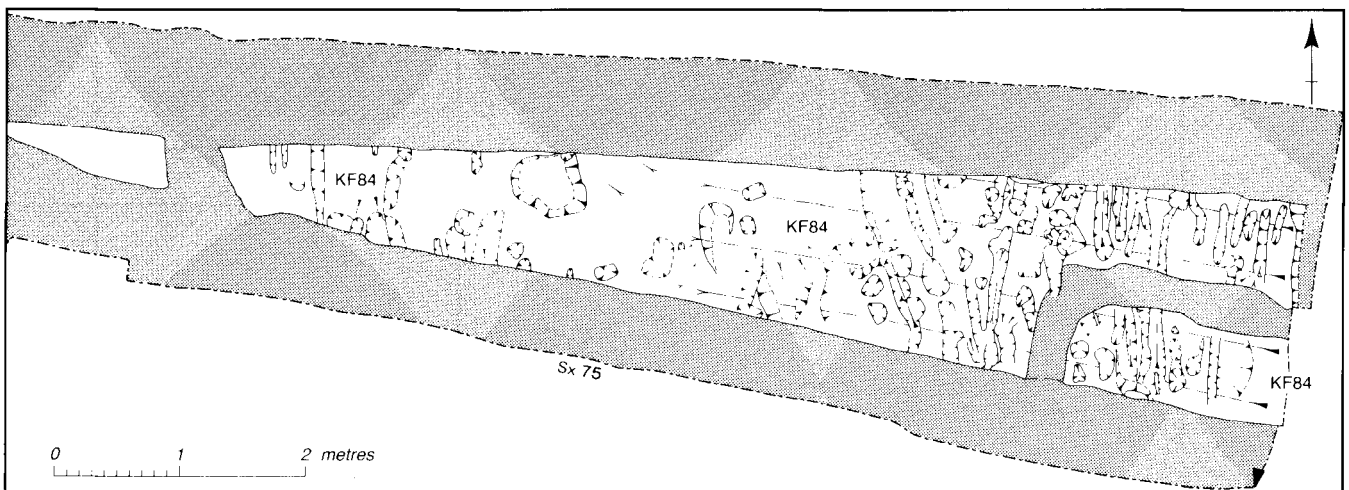
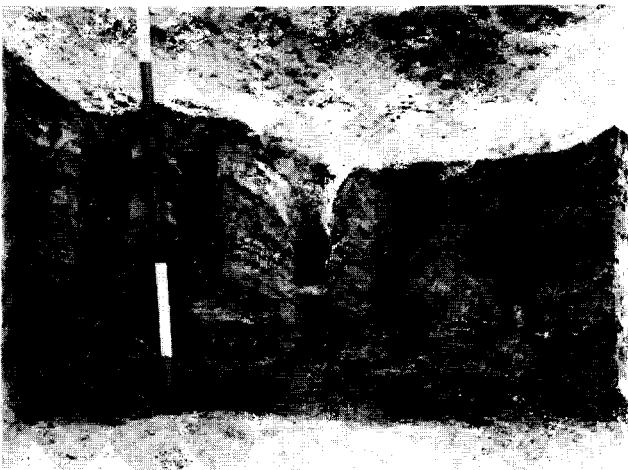
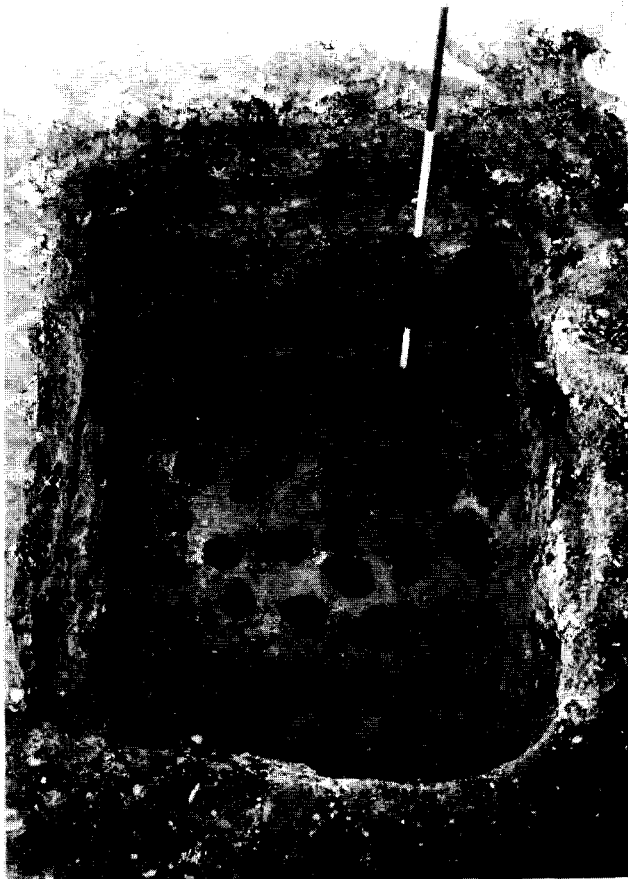


Fig 118 The wheel ruts KF84 (Period 4b, Balcerne Lane, Site K). [Page 123]



*Fig 119 Building 53: holes left by decayed piles (above) and section through holes (below). [Pages 126]*

Sheet 6b, & Sxs 66, 67, 69, 70, & 78, microfiche). These layers consisted entirely of oysters mixed with a little animal bone. They were laminated and thus clearly derived from a series of small deposits tipped over a period of time. They represent waste straight from the kitchen which is why very often there was little or no soil between the layers. The debris was dumped directly on to what must have been in effect small, public (but probably unofficial) middens to either side of the street. The main phase of dumping took place during Period 4 (Period 4c on Site K) although small tips of oysters with some bone were dumped around the possible altar base on Site K during Period 5.

## **Buildings 54-8 & Plot F (Plots A-F; Periods 5b & 5c)**

[BKC Sites G & T; general plans Fig 102, p113, & Fig 105, p114; detail plans Fig 104, Sheet 4b, & Fig 106, Sheet 5a; large-scale plan Fig 120, p129]

Buildings 54-8 (Fig 106) were superficially examined when on Site G the latest Roman levels were excavated before machine stripping (p1). The levels concerned were of Period 5c. In addition, the lowest parts of features belonging to the buildings were found and recorded on Site T which was set out after the machine work. Most of these features were not detected on Site G and on the basis of their datable contents they are attributable broadly to Period 5b. Very little is known about the earliest levels of the buildings so that in some cases there may have been more than one period of building. Similarly, knowledge of the buildings in their latest forms is also sketchy although it is likely that the best preserved of these (Building 55) was typical of them all. The layers associated with the buildings were characteristically of topsoil and were difficult to excavate because of their similarity with one another. Most of the Period 5c features were on the site of the demolished Building 59; these seemed to have been related to structures behind Building 54.

Buildings 54-8 (Figs 104 & 120) were strip-houses laid out along the south side of the London-Colchester street. On the north side of these and contained within them was a corridor delineated on its north side by a foundation (TF108). Building 58 was different from the others and seemed in Period 5b at least to have extended 1.5m north of this foundation and ended at a ground-plate which was laid directly on the surface of the ground. Divisions between the properties were indicated by breaks in the foundation along the south side of the passage (ie between Plots A & B, & Plots C & D) and a change in the materials used to build it (ie between Plots B & C). Also significant in this respect was the east end of the north foundation of the footway which coincided with a point in line with the junction of Plots D and E. In Trench 2 on Site G, the eastern end of an earlier foundation (GF25) lay slightly south of TF108 and corresponded with the probable boundary between Plots E and F. It is not clear what the relationship was between this foundation and a possible ground-plate to the north (GF36/GF149/GF194).

The only place where Buildings 54-7 incorporated foundations was along the frontage (with the possible exception of GF6) as if the north walls had been replaced with something more substantial. This would appear to have been akin to the practice common in the 18th and 19th centuries where timber-framed buildings were made to look modern by placing a brick façade in front of their principal elevations. However whether the foundations in Buildings 54-7 are indicative of a face-lift such as this cannot be established.

A striking feature of Buildings 54-7 is the group of ovens of Period 5c which lay in a row about 7 to 10m back from the street frontage (Figs 106 & 120). There



were four of them, one for each property and all aligned on the street. These matched in position and period the ovens in Plot J which lay a similar distance back from the frontage on the opposite side of the street. It is not clear if the ovens were inside the buildings or in yards behind them. Their alignment favours the former but their common distance from the frontage suggests that the buildings were quite short and that the ovens were in backyards. No enclosing structures were found around any of the ovens although this may simply reflect the poor survival of structural features of this period and the difficulty experienced in detecting them. By contrast the remains of the ovens, being burnt red, were obvious.

The site of Building 54 had been extensively damaged when St Mary's Terrace was built. The earliest remains were some bases of packed septaria (TF3, TF6, TF7, TF12, TF13, TF14, TF133, & TF134). Most of these formed a line roughly at right angles to the street and clearly must have corresponded with a partition. All the bases post-dated Building(s) 47 but could have belonged to Period 4. Patches of mortar floor survived on the east side. These sealed two of the septaria-packed bases. The latest surviving remains were also slight and clearly not representative of the building in its final form. These consisted of narrow slots across the width of the footway (GF148-9, GF197, & GF200-1) and an oven. The function of the slots is not clear; perhaps they were formed by the joists of a wooden floor or platform.

Some ovens, pits, possible post-pits and stake holes were situated to the south of Building 54 but still within the plot occupied by it (Plot A). These cut the demolition debris sealing the floors of Building 59 and seemed to have been associated with a variety of structures probably of different phases. Within the possible post-pits was a clear line (Fig 106: HF124, HF115, HF46, HF106, HF95, HF62, HF58, HF174, & HF61) suggesting the presence of a fence perhaps of several phases. If correct, then Plot A may have been subdivided and the row of posts indicates the position of the new boundary. An alternative interpretation is that the possible post-pits belonged to a post-built timber building although it is difficult to rationalise the pits in terms of a convincing plan. North of the row of pits was an oven (HF60) in the form of a shallow oblong pit with burnt sides. On the south side of the row at its west end were some stake holes; these indicated structures in this area. Seven of the stake holes were larger than normal being 0.15m across and on average over 0.7m deep. They all occurred where there had been exceptionally severe subsidence into one or more pits under the floor of Room 8b of Building 59. Four of the holes (HF63-6) formed a neat group reminiscent of piles found elsewhere in the town (p20). They may have been intended to counteract subsidence and were either simply stakes of exceptional thickness or proper piles which supported a structure at or close to the ground level of the time.

Building 55 had been destroyed by fire with the result that its remains were comparatively distinct. The building had framed walls with ground-plates, parts of which were still *in situ* as charcoal. Elsewhere slots indicated the positions of other ground-plates. Three rooms are discernible. Two of these shared the frontage and were of equal width whilst the third lay on the south side of the slot GF170 and contained in the north-west corner a large pit (GF108) 0.2 m deep. The north wall, although not clearly detected, incorporated a ground-plate on top of the foundation TF2. In the footway slots were found which were similar to those of Building 54. In addition there was a large slot (GF21) of uncertain purpose. It was 0.3 m deep and had vertical sides. Two votive pots (GF171 & GF172; Appendix 8, microfiche) lay under the ground-plate GF170.

In the middle of Plot B, well behind Building 55, was a fragment of a small mosaic (Fig 121). It had nearly been completely destroyed in the 19th century when St Mary's Terrace was built and is almost certainly the mosaic found by Laver (p 131). All that survived of the pavement were a few rows of white tesserae surrounded by some patches of red tessellation. The walls of the room in which the mosaic lay must have been built on very slight foundations since no trace of these were found. Although it is possible that the mosaic was part of Building 59, the structural difference implied by the absence of foundations around it plus the position of the pavement in relation to the postulated boundaries of Plot B support the assumption that the pavement was part of a separate building which had the same relationship to Building 55 as did Building 59 to Building 54. Further excavation within Plot B would probably have clarified this point but this was not possible.

The principal remains of Building 56 consisted of a cellar and an oven (GF85). The cellar was probably secondary since it was set in a large construction trench (TF25) which seems to have been dug within the confines of the front room. This explains why the cellar was substantially narrower than the room above it. The cellar was built of planks held in place by fourteen uprights about 0.95m apart with an additional upright in the centre. These were detectable in the north and east walls. The cellar had been backfilled and the wooden walls left to decay in position. The construction trench contained a large quantity of pottery of c 250-325 and three coins the latest being of 162-3. The backfill of the cellar was largely unexcavated and no useful dating evidence for it was found. However the cellar had presumably been backfilled before the end of Period 5c because it was not visible until after the machine stripping of Site G.

Very little is known about Building 57. The party-wall between Buildings 57 and 58 may have been built on a mortared foundation since in this position there was what appeared to have been a recent robber trench (GF6). The oven (GF67) was well preserved and, at the opposite end to its mouth, had a hard burnt surface which may have been the remains of another oven. A



hearth or part of an oven made of tile (GF15) was found in the south end of Trial Trench 2; this was of Period 5b (Fig 104).

Building 58 was different to the others as previously explained since it did not share the passage along the street and its front wall was not built on a foundation. During Period 5b Building 58 possessed a tile hearth (GF12) apparently in the centre of a room and an oven (GF38) close to the north wall. A votive pot (GF7), placed by the west wall, also seems to belong to this phase.

Plot F was destroyed when the western part of the wide defensive ditch was dug. The western edge of the ditch coincided neatly with the northern end of the boundary between Plots E and F suggesting that when this part of the ditch was dug Building 58 was in existence. The western edge of the ditch changed direction at a point 8 m south of the street frontage and cut across Plot E indicating that Building 58 was

probably no more than 8 m long. This supports the hypothesis discussed above that the Period 5c buildings were short and that the ovens were outside.

### Building 59 (Plot A; Period 5b)

[BKC Site H; general plan Fig 102, p113; detail plan Fig 104, Sheet 4b; large-scale plan Fig 121, p130; photograph Fig 122, p131; profile across foundation Fig 123, p230 (microfiche)]

The well preserved remains of a house (Building 59; Figs 102, 121, & 122) were situated about 17 m south of the London-Colchester street. The position implies that the house must have been built to the rear of buildings fronting directly on to the street and belonging to the same property (Building 54; Plot A). The north-east corner of the building and the upper part of its northern foundation had been destroyed

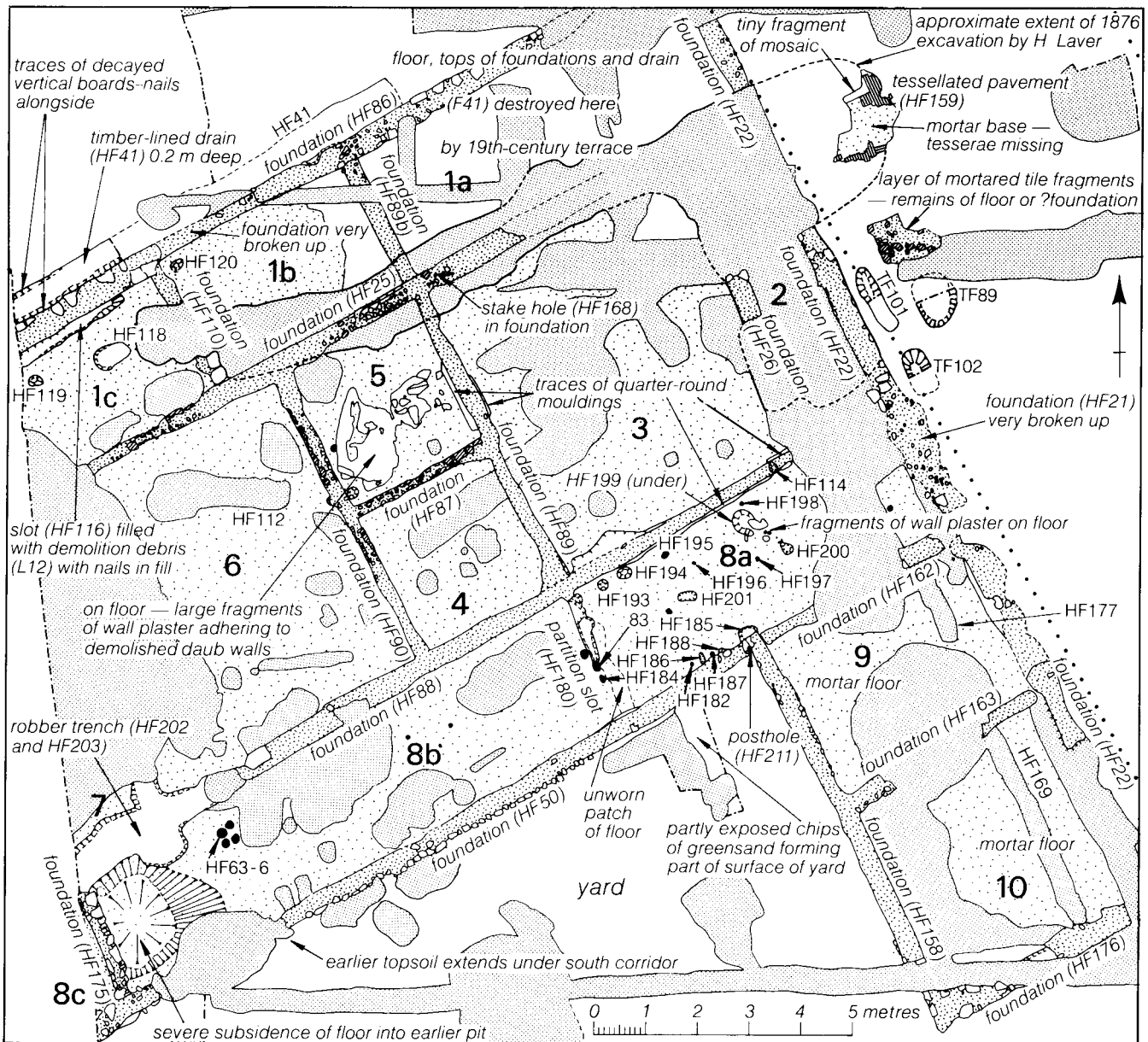


Fig 121 Building 59. 1:125. [Pages 130-2]



Fig 122 Building 59. [Pages 130-2]

when St Mary's Terrace and the houses to either side were built in the 19th century. (The area between the two opposing terraces was substantially lowered.) Another part of the house had also been badly damaged at about the same time during what appeared to have been an archaeological excavation in which the technique was to trench along the foundations so that they could be exposed (in this case HF25, HF26, & HF22). This must be the investigation of a 'Roman villa' undertaken somewhere in the area by Dr H Laver and a party of sappers in 1876 (Hull 1958, 243). The pavement uncovered at the time is probably the mosaic HF159 (Fig 121). Only part of Building 59 was available for excavation (Rooms 1-10).

The walls were timber-framed with ground-plates set on stone and mortar foundations. The foundations were mostly still intact and the floors were sealed by a layer up to 50 mm thick of daub and wall plaster left

after the demolition of the house. Substantial quantities of broken wall plaster painted red, white and black lay on the floors of Rooms 1b, 3, 4, 6, 8a and especially 5 (shown on Fig 121; report on p153). The remains survived of quarter-round mouldings at the bottoms of the walls in Rooms 3, 5, and 8a. The foundations were of two types. One kind was formed by first filling trenches 0.45-0.50 m wide and 0.25-0.30 m deep with septaria, gravel and mortar. They were then raised to a height up to 0.25-0.40 m with the addition of courses of mortared septaria and finished off with a single course of broken tile held in place along the outer edges by mortar 'shoulders' (Fig 123, microfiche). The second type of foundation was of the standard variety; trenches 0.5-0.7 m deep were filled with septaria and mortar up to ground level and the upper surfaces were tamped and smoothed with a trowel or another suitable tool. Some of the upper surfaces of these foundations preserved the impressions of squared timbers and in some

instances even wood grain, as if the ground-plates had been put in place before the mortar had set (not possible with shouldered foundations). The northern half of the house appeared to contain only the shouldered type of foundation suggesting that the building had been constructed on a site which sloped slightly to the north. (The nature of the north foundation HF86 is unclear because the upper part was missing.) No details could be recovered about the type of framing used in the walls other than that ground-plates were incorporated.

Three principal structural phases were identified. These were indicated by the relationships between the foundations and also differences in the construction of the floors. In its original form, the house (or at least the part of it examined) consisted of five rooms (Rooms 2+3, 4, 5, 6, & 7) and a passage (Room 1). Phase 2 saw the addition of a passage (Room 8) on the south side. In Phase 3, a small wing (Rooms 9 & 10) was added to the east end of the passage of Phase 2.

The two passages were subdivided into rooms (Rooms 1a-c & 8a-c) by the insertion of four partitions. The relationships of these to each other and to the three main structural phases of the house are obscure. Foundations HF175 and HF180 must have been later than the alterations of Phase 2 because they were inserted into the Phase 2 passage. Moreover both differed in character indicating that they were probably not built at the same time. The partition HF175 was of stone and mortar whereas HF180 was a shallow slot with two post holes (HF183 & HF184) at its southern end which, like the slot, were cut into the floor of the Phase 2 passage. The other two partitions (HF89b & HF110) were of mortar and stone; all that can be deduced about these is that they post-dated Phase 1.

A shallow slot (HF177 & HF169) had been dug along the east sides of Rooms 9 and 10 as if to form a narrow, secondary passage. The slot was much shallower where it was close to the foundations HF163 and HF176 showing that these existed when the feature was dug. The slot may have been left after the removal of a ground-plate. Equally it could be a spurious feature of Period 5c or 6 or a trench dug by Laver.

All the floors were made of pale brown mortar containing many small stones and chips of tile. They all had reddish surfaces. The floors in Rooms 2 to 7 were laid on make-up which consisted of a layer 0.06 m thick of stoney sand over a deposit of silty clay loam up to 0.30 m thick. (The floor of Room 1 had been completely destroyed but was presumably similar.) The floors in Rooms 8 to 10 were of a slightly different character and thus were of a different phase. They were coarser in texture since they contained larger stones and fewer chips of tile.

The relationships between the foundations were as follows (Fig 121):

- a) HF110 cut the side of HF86
- b) HF89b butted against HF86 and HF25 and was of a different construction to them

- c) HF158 cut HF50/HF162
- d) HF175 butted against HF50
- e) HF180 cut into the mortar floor of Room 8.

In Rooms 1b, 1c, 8a, and 8b, there were various small features sealed by the demolition debris (HF120, HF182, HF185-HF188, HF193-HF201). These were commonest in Room 8a and were similar in character to the partition HF180 with which they were probably roughly contemporary.

Along the north side of the north wall, there was part of a timber drain (HF41). Nails were still *in situ* along both sides of the drain showing that it had been of similar construction to that of Building 8 at Lion Walk (p40). It probably extended along the full length of the house except that traces of its eastern end had been removed in the 19th century when St Mary's Terrace was built (*see above*). On the south side there was limited evidence in the form of greensand chips for a metallised backyard (Fig 121).

Examination of Building 59 was restricted to exposing its floors and excavating all the features and layers which cut or sealed them. When this process was completed, the area (including Site G) was lowered by machine to expose what was taken to be the remains of the Boudican destruction. In this way Site T was formed and little dating evidence could be recovered for the construction of the house. Nevertheless some limited material was obtained which lay immediately under the floors and thus predated the building (T311, T252, T256, & T334). Here the latest sherds were of black burnished ware (T252) indicating for the group a date no earlier than Hadrian.

The terminal date of the house is well established from the substantial quantity of finds found in the demolition debris which lay on the floors. This contained much pottery of 150-250 and coins struck during the following periods: 98-117, 140-4, and 141-61 (plus an illegible example of the late 2nd or 3rd century). As a group, the coins are typical of those in circulation until *c* 250 and thus like the pottery indicate that the house was knocked down no later than the mid 3rd century. Thus Building 59 belongs firmly to Period 5b with the possibility that it was built in Period 5a.

### Building 60 (Periods 5b & 5c)

[BKC Site J; general plan Fig 102, p113; detail plan Fig 104, Sheet 4b; large-scale plans Fig 124, p133; photograph Fig 125, p134]

The area of Building 60 (Figs 124 & 125) had been badly affected by modern terracing so that all the floor levels and the foundations at the east end had been destroyed. The latest floor levels (JL17 & JL18) only survived where they had subsided into the fill of earlier features. The walls of the building were of mortared septaria on a shallow foundation of sand and small stones. Externally the building was about 6.1 m across with walls 0.4 m wide. It appears to have been a workshop of three phases.

The first phase was associated with a double-chambered oven (JF52). This was built of roughly

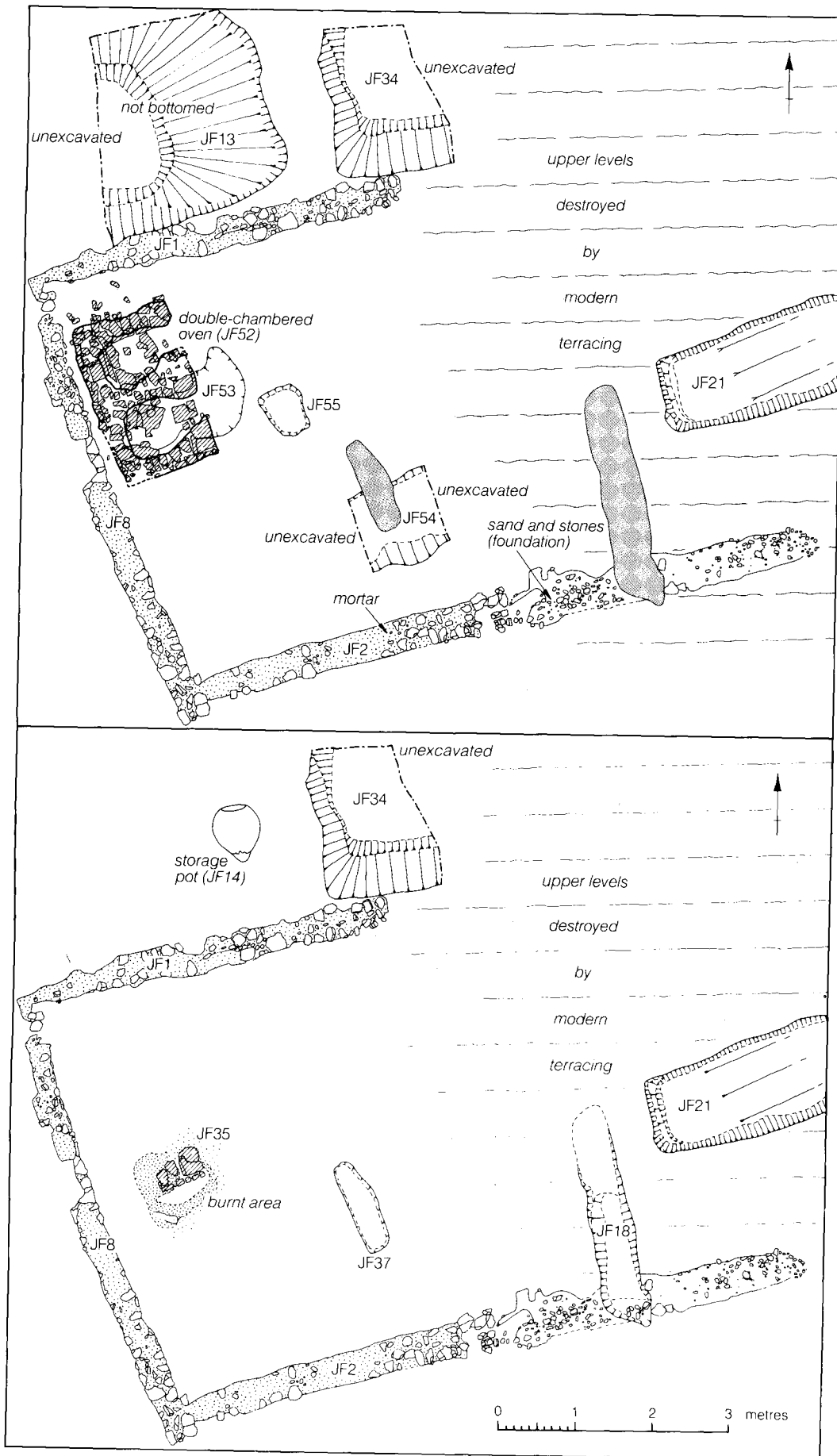


Fig 124 Building 60: Phase 1 (above) and Phase 2 (below). [Pages 132-4]

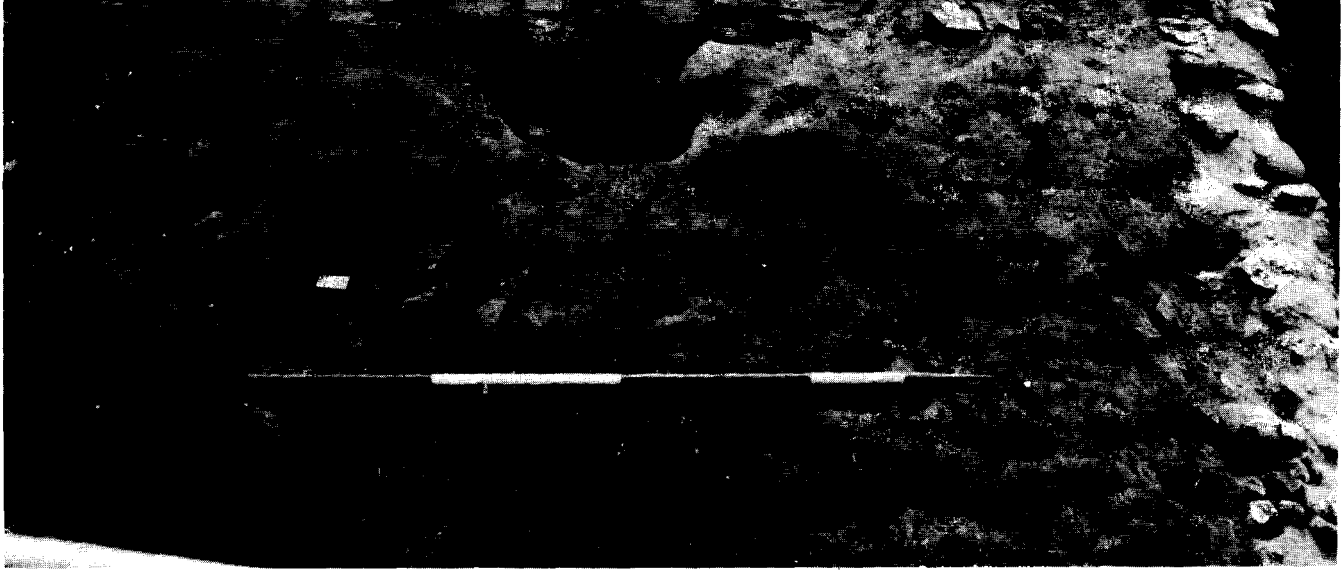


Fig 125 Building 60, Phase 1. [Pages 132-4]

coursed broken roof and building tile bonded with daub. Three courses survived. The oven measured about 2.2 x 1.4 m. Repeated raking out of debris from the southern chamber caused the formation of a shallow pit (JF53). Since this was filled with ash (JL30) which sealed the main occupation and floor levels associated with JF52, it seems likely that the southern chamber continued in use some time after the north chamber. Both had probably been relined. Two small pits (JF54 & JF55), also filled with ash, were probably associated with this phase. Outside the north wall and butting against it were two deep pits (JF13 & JF34) neither of which was completely excavated. The pit JF13 had been recut at least once and had an irregular, platform-like eastern side. An important object in JF13 was an oculist's stamp (*CAR 2, 1951*) found about 0.15 m from the north wall.

The start of the second phase was marked by the demolition of the double-chambered oven and its replacement by a hearth or another oven. All that remained of the replacement was a roughly circular burnt patch about 1.0 m across which included the uppermost surviving tile fragments in the base of the double-chambered oven. Interpretation was difficult because there was no surviving superstructure and the burnt layer itself had been sheared off. An ash-filled slot (JF37) belongs to this phase.

The final phase began with the demolition of the oven or hearth JF35. The resulting layer of debris (JL17), where it survived as settlement into earlier features, was sealed by a layer of occupation showing continued use of the workshop. No structures can be linked with this phase.

Outside the north wall, a storage jar (Appendix 8, microfiche) had been placed on its side in the backfilled pit JF13 so that its mouth was horizontal and facing southwards. It had been used as an oven. Only the lower side survived, the rest having collapsed inwards.

The upper fill of pit JF34 contained large lumps of mortar, daub and wall plaster, all of which came from the demolition of a nearby building. The presence of painted wall plaster suggests that this is unlikely to have been the workshop itself. Contained in the upper fill of the pit was a coin of 268-70.

The alignment of the slot JF18 and the long pit JF21 coincided with that of the workshop and thus these features may have been contemporary with it. However the slot JF18 possibly cut the south wall and therefore may have been later. The sides of the slot JF18 were stained green which is possibly indicative of specialised usage (p63) and JF21 was filled with largely sterile soft dark brown soil.

## Building(s) 61 (Periods 2 &/or 4)

[BKC Site V; general plan Fig 99, p112; detail plan Fig 101, Sheet 3b; large-scale plan Fig 112, p120]

To the south of the sites of Buildings 46 and 51 on Site V were the remains of buildings which had been orientated east-west. The remains must have represented more than one building but for simplicity they will be referred to by one number. Much erosion had occurred during the cultivation of the allotments (pp 138-40) so that it was only the lowest parts of the features belonging to these buildings which survived (Figs 99, 101, & 112). These were found and excavated in two areas: the north-east part of Site V immediately south of the remains of Building 46, and south of the ditch VF130 in one of two small trenches dug to examine the east-west street at the south end of Site V (Fig 101, inset). Little useful dating evidence was produced from the first of these apart from the ditch or gully VF44 which contained Flavian pottery and two coins of 64-8 and 73-4. In the other area were uncovered many stake holes, several small pits, an oblong pit or gully (VF153) and several ovens or hearths. The last of these consisted of five burnt patches (VF180, VF215-6, & VF220) and the base (50 mm deep) of a small pit (VF170) which had burnt sides.

Like Buildings 44-6, these must have been strip-houses which fronted on to a north-south street to the east and, because of the positions of the defensive ditches of Periods 1 and 3, could only have belonged to Periods 2 or 4. Although the ditch or gully VF44 plainly was of Period 4, not all of the remaining features need have been of this period.

The remains of a baby lay in a layer of presumed make-up (VL54) probably associated with Building(s) 61 (Appendix 1, microfiche).

## Buildings 62 and 63 (Plots I & J; Period 5Na)

[BKC Site N; general plan Fig 99, p112; detail plan Fig 101, Sheet 3b; large-scale plan Fig 126, p136]

On Site N the stratigraphy to either side of the boundary between Plots I and J was different throughout the whole period of Roman occupation and thus showed the position of a property boundary.

Only small parts of Buildings 62 and 63 (Fig 99, 101, & 126) were excavated and as a result little is known about their plans or arrangement of rooms. Part of a mortared plinth (NF148) was uncovered. This formed the frontage of Building 63 and stopped at the junction with Building 62. No other plinths of this period could be found, thus indicating that the other walls were probably set directly on the ground. This includes the frontage wall of Building 62. Immediately north of the plinth was a gravelled area which was probably the floor of a room. Elsewhere in Buildings 62 and 63, the floors were of daub.

## Buildings 64 and 65 (Plots I & J; Periods 5Nb(1) & (2))

[BKC Site N; general plan Fig 102, p113; detail plan Fig 104, Sheet 4b; large-scale plans Fig 126, p136, & Fig 127, p137]

Buildings 64 and 65 were of two phases. In Period 5Nb(1), Buildings 62 and 63 were demolished and replaced with Buildings 64 and 65 respectively (Figs 104 & 126). The party-wall between the two buildings was built on a mortar foundation (NF146) and along their south sides was a footway similar to the one shared by Buildings 54-7 opposite. The floors of Building 64 were mainly of gravel. Cut into the floor of the passage were two slots possibly for joists of a timber floor. To the rear of Building 65 was a cellar 2.4 m deep, with walls of septaria and tile (Sx 81, microfiche). Near the top of the east wall of the cellar was a gap for a window or a chute (Fig 126) and in the floor, buried upright, was a votive pot with a bowl for a lid (NF31; Appendix 8, microfiche). The east wall of the cellar lined up with a foundation (NF145) which formed the east side of a room in Building 65. The dimensions of the cellar are not known (apart from its depth) although if, as seems likely, its west wall was on the boundary between Plots I and J then the cellar would have measured internally about 4.8 m across.

The latest Roman levels to the east of Buildings 64 and 65 were examined and no substantial traces were detected of any buildings. However, to the north and set upright in the ground, was a globular amphora with its neck missing (NF116; Appendix 8, microfiche). It was placed so that the top was at ground level.

In Period 5Nb(2), the wall along the frontage was knocked down and its foundation (NF153) sealed by fresh gravel deposited as a floor along the passage (Fig 127). The wall on top of the foundations NF144 and NF147 was retained although the fate of those to the north of this is less certain. The apparent absence of walls in this area may reflect poor survival of the evidence necessary for their detection and the limitations of the excavation. In the passage at the south end of Building 65, more slots (NF118-NF121) were found suggesting the presence of another timber floor. Crossing the passage were two slots, the purposes of which are obscure. The slot NF125 may have been a timber drain. It had vertical sides, a flat base and was stained green. It seemed to lead from a clay-lined pit (NF122) to the roadside drain (NF75). The other slot (NF97) was less well defined and perhaps may have held a ground-plate.

The remains of four poorly preserved ovens lay to the rear of Plots I and J (Fig 127; NF36, NF61, NF77, & NF115). Like those on the other side of the street (p127), it is not clear if the ovens were inside buildings or not. Three of them (ie all but NF77) shared the same alignment as Building 65 and may well have been contained within it. If not, then the cellar would have been detached from the building on the street frontage and thus was perhaps the southern end of a more substantial building to the north-west. The ovens cannot be ascribed to either phase of Period 5Nb; however they were plainly not of Period 6 since they were cut by features of that phase.



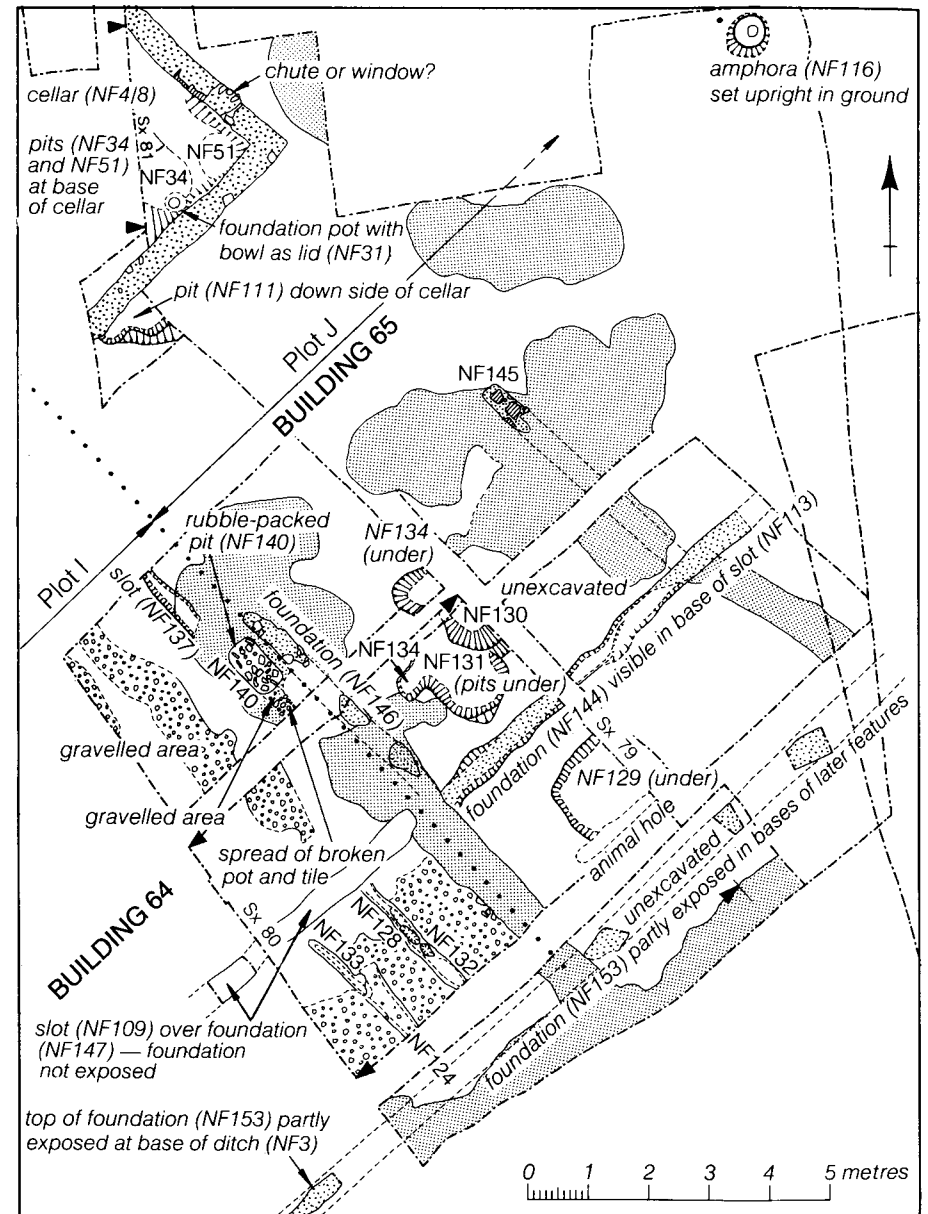
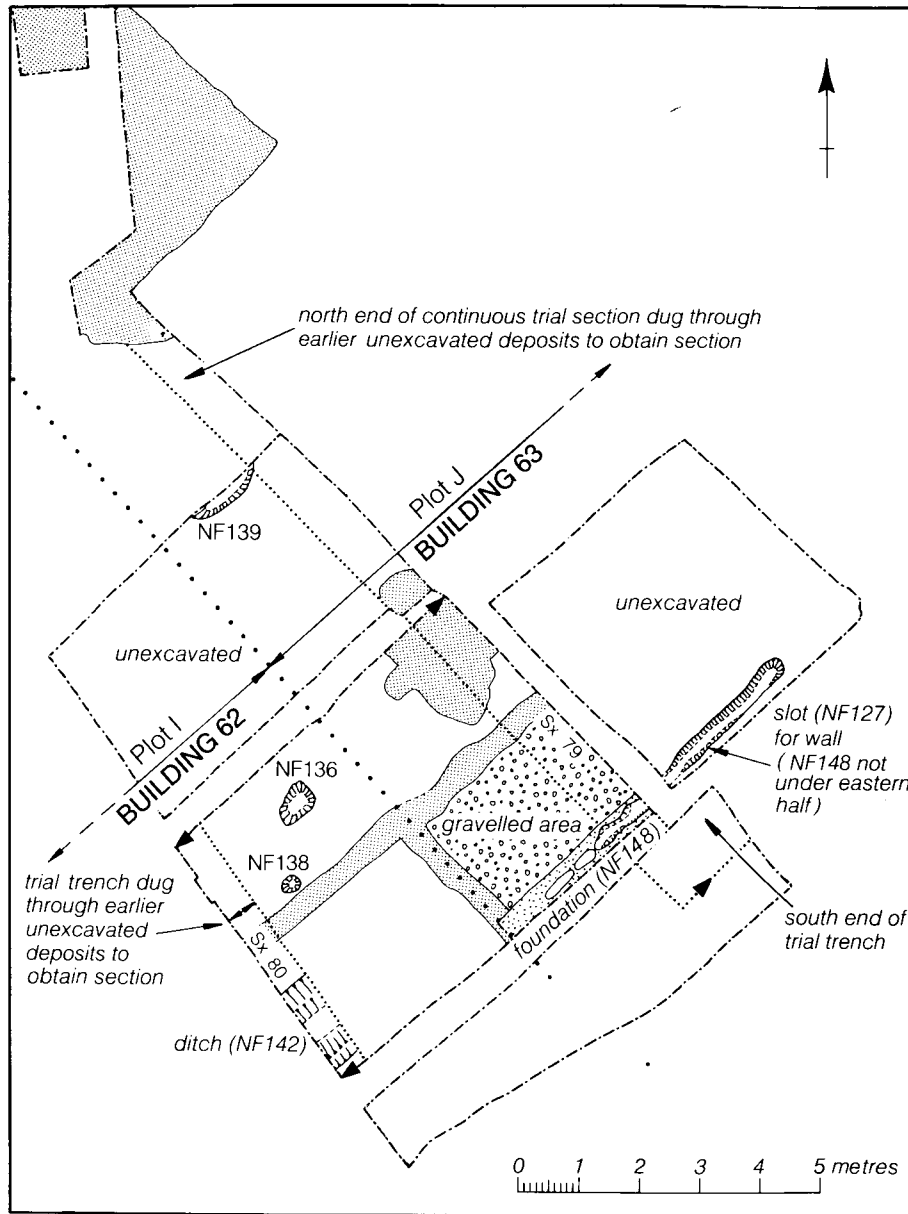


Fig 126 Buildings 62 and 63 (left: Period 5Na) and Buildings 64 and 65 (right: Period 5Nb(1)) 1:125. [Page 135]

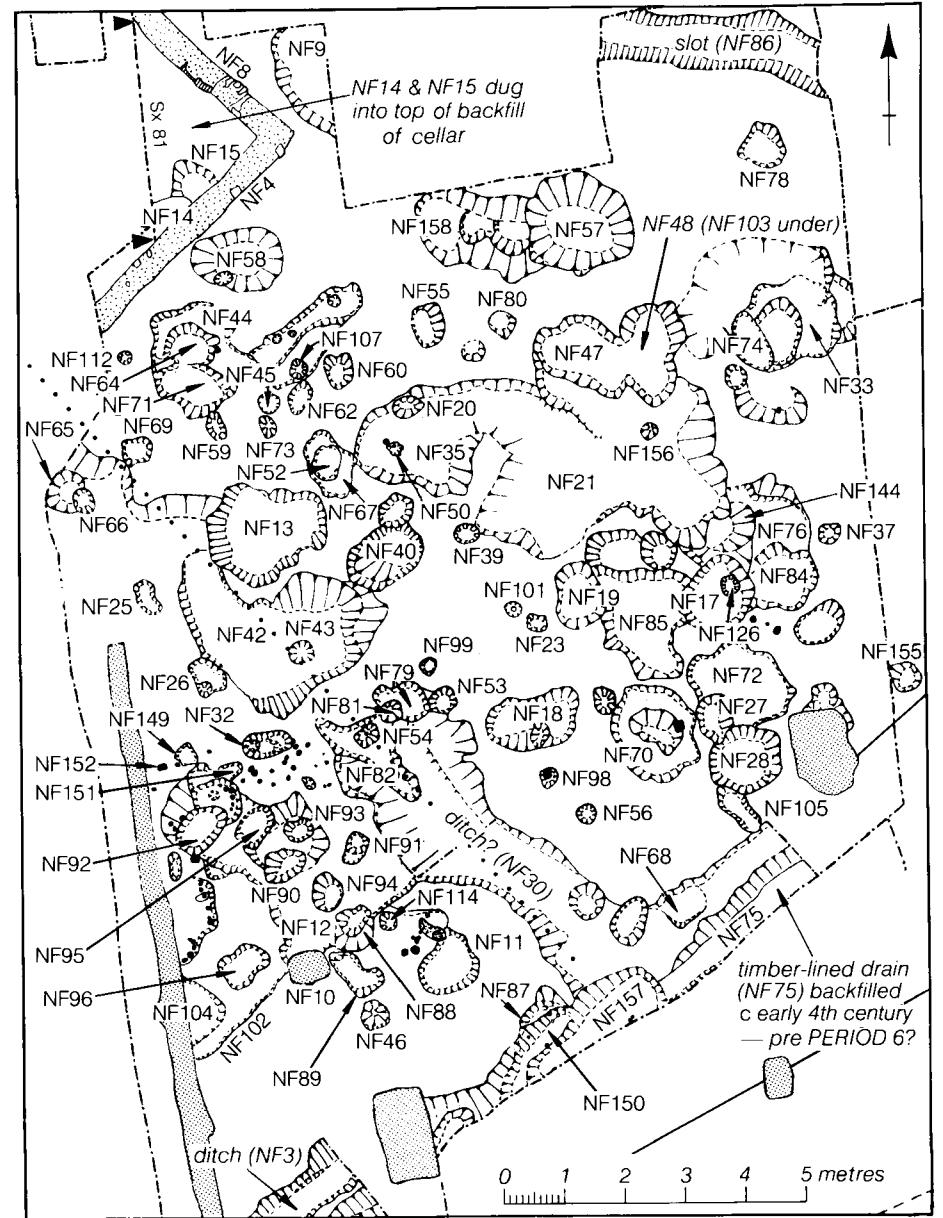
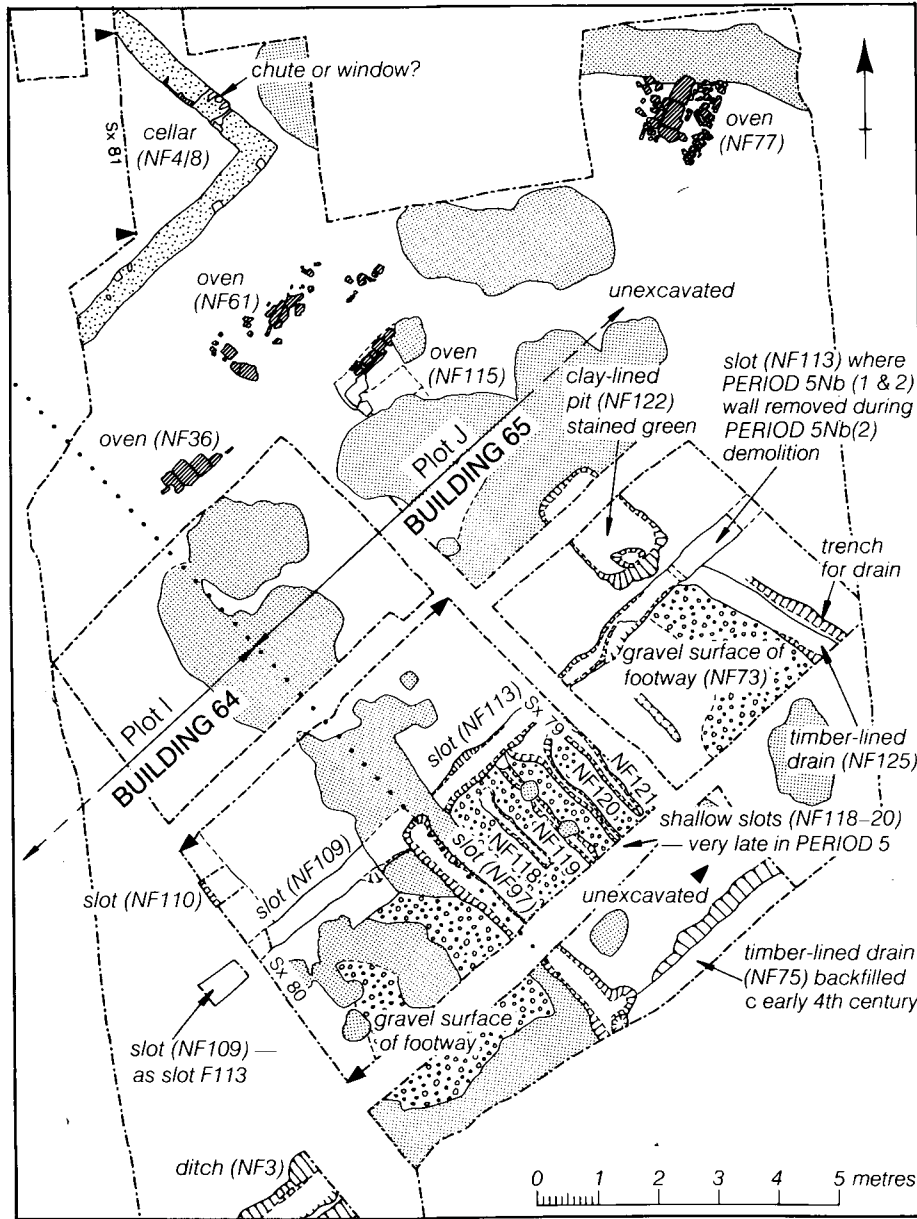


Fig 127 Buildings 64 and 65 (left: Period 5Nb(2)) and complex of small pits on Plots I and J (right). 1:125. [Pages 135 and 142]

## The drainage system of Periods 5b and 5c

[BKC Sites G & N; general plans Fig 102, p113, Fig 105, p114; detail plans Fig 104, Sheet 4b, Fig 106, Sheet 5a; large-scale plans Fig 120, p129, Fig 127, p137]

The street was lined on both sides by timber drainage systems. None seemed to have contained nails. The drainage system on the south side of the street was of two phases which corresponded broadly with Periods 5b and 5c. Hints of a third and earlier system were provided by faint traces of what appeared to have been a drain in Trial Trench 7 about 2 m north of Building 58 (GF196; Fig 104). The date of the possible drain is obscure; it could have been of Periods 4 to 5b.

In Period 5b along the south side of the street, there seems to have been a single timber drain (GF180/GF148/GF186; Fig 104) which crossed the width of Site G. This was detected in Trial Trenches 1, 3, 4 and 5 where in each case faint traces of decayed wood were found but no nails. The drain was 0.6 m across and 0.3 m deep. It was laid out to pass within 0.2 m of the foot of the north wall of Building 58. The second phase (Figs 106 & 120) was more complicated and its components bore some relationship to the plots to the south indicating that they belonged to these properties. The principal element was a timber drain (GF11) which was 0.4 m deep and contained no nails in its sides or in its fill. The east end of the drain coincided with the east limit of Plot D. The west end was obscure but probably matched the west side of Plot B so that the drain was shared by Plots B, C, and D. On the north side of Plot E, the drain was continued eastwards as a drain or a shallow ditch which in its final form was irregular and cut by a pit GF141. This in turn continued on the north side of Plot F as a substantial ditch (GF2; Sx 72, Sheet 6b) which probably led directly into the town ditch. West of drain GF11, the position is not so clear. The line of the drain (if not the drain itself) was detectable westwards for at least 7 m but did not reach Trial Trench 1. The backfill of the drain GF11 contained very large quantities of pottery datable to c 250-325 and many coins, the latest being of 260-8. On the north side of the street, the drainage system was not so clear. To the south of Building 65, there was a timber drain (NF75; Fig 127) backfilled in about the early 4th century. This appeared to have been continued westwards along the south side of Building 64 as a ditch or another drain (NF157/ NF3).

## The street at the south end of Site V (Periods 4-6)

[BKC Site V; general plans Fig 99, p112; & Fig 105, p114; detail plans Fig 101, Sheet 3b, & Fig 106, Sheet 5a]

A gravelled street (Figs 8, 99, & 101) found at the southern end of the Balkerne Lane site was laid out in Period 4 (Sxs 86 & 87, microfiche). Part of this was excavated in two small trenches to establish its character and period of use. The eastern trench proved to contain little of value since it was in an area which had been largely destroyed in the 19th century.

The street was resurfaced several times, the latest surviving metalling being of 2nd-century date. The full

width of the street is unknown but it seemed to thin out in the south-west corner as if it had not been much more than about 5.0 m across. The total thickness of metalling was 0.7 m. The street had a ditch (VF130) along its north side. This was the best indicator of the street's direction which seemed to be close to east-west and matched the direction of the cultivation beds of Period 5 (*see below*). The earliest metalling sealed a thick deposit of sandy dumped material containing Flavian pottery and a coin of 71-2 (Sx 86, microfiche). Under the dump was a series of features which belonged to one or more buildings predating the street (*see above* Building 61). Some east-west wheel ruts (VF115; Fig 101, inset, Sheet 3b) cut into the Period 4 metalling. Contemporary with these were some small features (VF32, VF82, VF129, VF143, VF147-8, VF160, & VF182) which were probably post-pits for a fence or a sequence of fences along the southern boundary of Plot H. The bottoms of several small pits and slots (VF28/89, VF33-5, VF37-8, VF59-61, VF71, & VF88) were found which had been cut into the street probably after it had gone out of use sometime during Period 5 or 6. A dog had been buried in a grave (VF10) placed by the southern boundary of Plot H, perhaps along the inside of a fence between the grave and the site of the street. Pits VF33 and VF61 may have been postholes for a fence in this position.

Two narrow trenches were dug in the south-west corner of Site V in an attempt to determine the direction of the street more accurately. The results of this work were not very helpful. No clear metalling was found and it was not certain whether the street had reached this far. This is surprising in view of the substantial nature of the metalling to the east. However a narrow ditch (VF313, Fig 106) was located, the position and direction of which were consistent with the south side of the street. Moreover to the south of the ditch was the base of a hearth or oven (VL117); this is in keeping with the presumed position of the street.

In Period 5, a ditch (VF218; Fig 106) was dug along the north side of the street. It was at a slightly different angle to the ditch VF130 which lay to the east and thus may point to a change in the direction of the street.

## The allotments (Plot H; Periods 3?, 4?, & 5)

[BKC, Site V; general plan Fig 105, p114; detail plan Fig 106, Sheet 5a; large-scale plan of contours Fig 128, p139; large-scale plan showing northern boundary Fig 112, p120; photograph Fig 129, p140; profile across part of the allotments Fig 130, p230 (microfiche)]

A layer of topsoil up to 0.5 m thick lay over much of Site V (Sx 87, microfiche). It extended from the southern edge of Plot G as indicated by ditches and post-pits (Fig 112) to the northern edge of the east-west street at the southern end of Site V. As a result of long term cultivation, the topsoil developed at the expense of the underlying remains of Building(s) 61. As the soil was broken up by digging or ploughing, the upper parts of the remains of Building(s) 61 were brought to the surface to become through time part of the topsoil. In this way, the depth of topsoil increased and the remains of Building(s) 61 were gradually destroyed

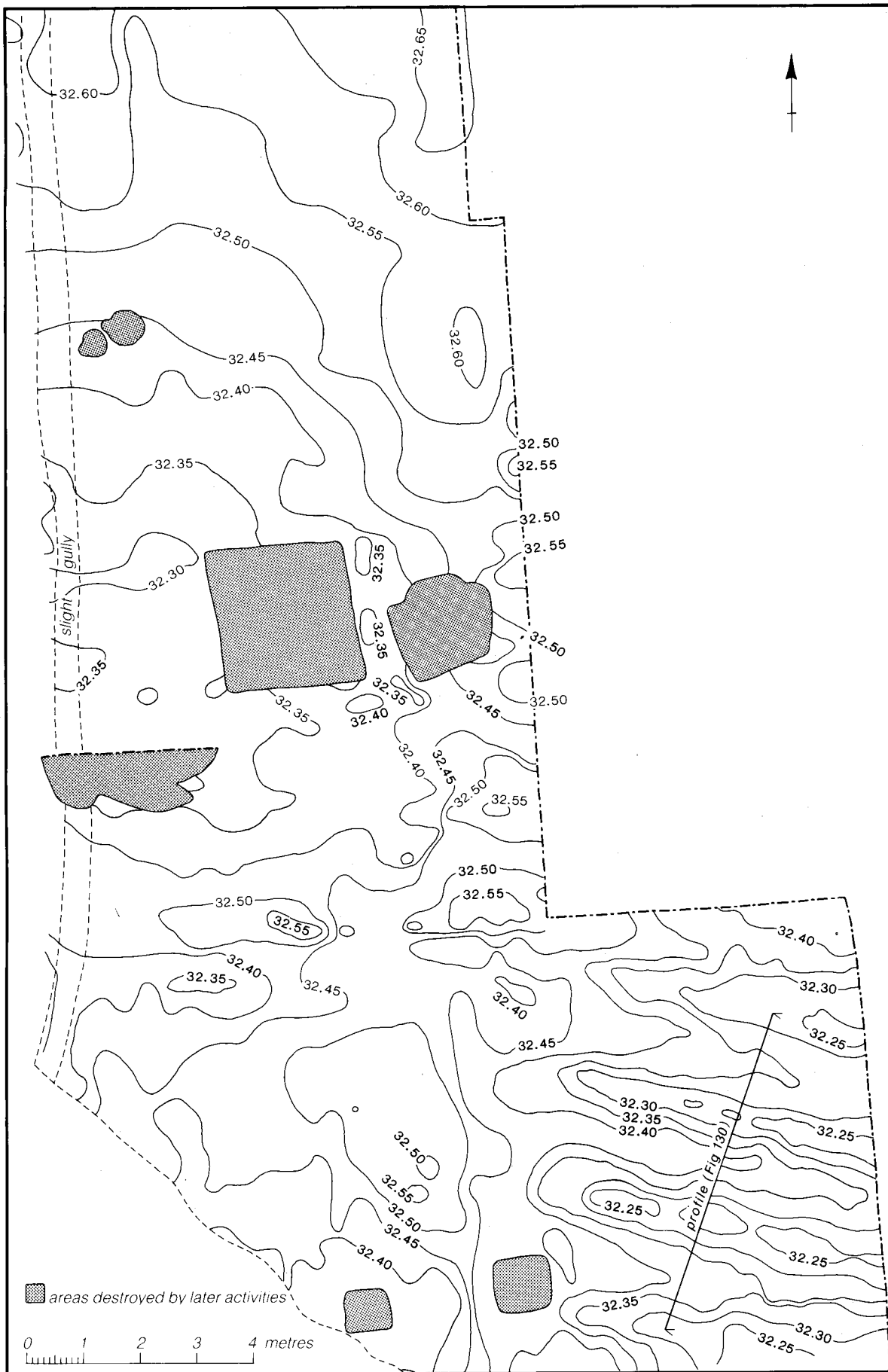


Fig 128 The contours of the allotments (Balkerne Lane, Site V). [Pages 138-41]

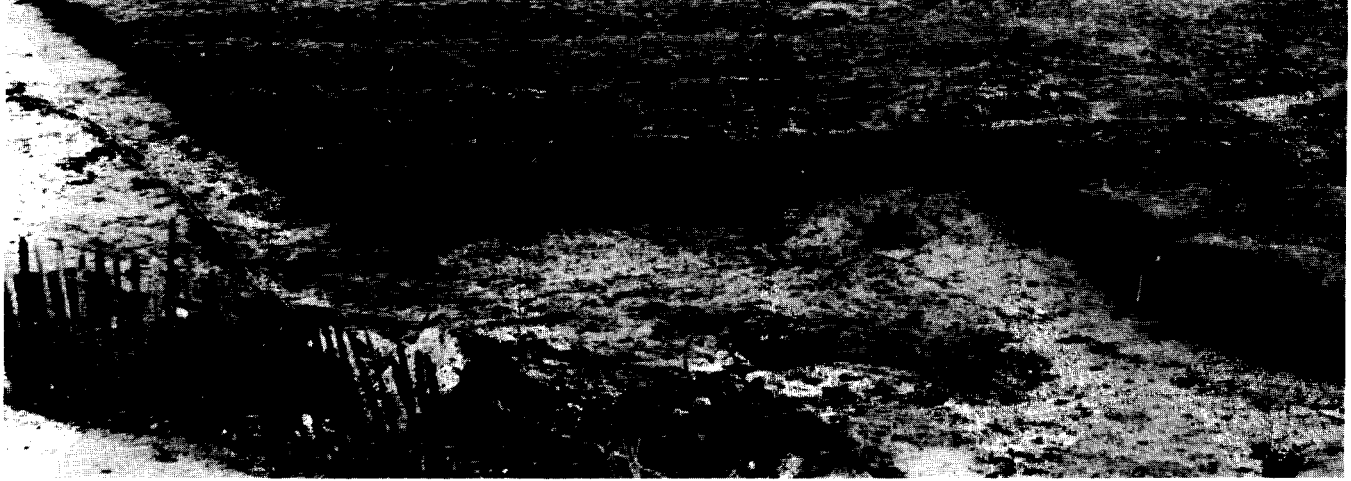


Fig 129 The cultivation beds. [Pages 138-41]

until only the bases of the features were left. A similar fate overtook part of the remains of Building 51 (Fig 111).

It is not certain when the allotments were laid out but probably this occurred at the start of Period 5 when Building(s) 61 was demolished and the Period 5 town ditch was dug. The latter had the effect of cutting Plot H off from the north-south street to the east and making access to the area difficult.

In c 275, a large quantity of sand, soil and occupation debris at least 0.4m thick was dumped over the allotments with the effect that the contours of the land surface at that time were perfectly preserved. Of great interest were nine beds for plants found at the southern end of the plot (Figs 128-9). They resembled medieval ridge-and-furrow but on a smaller scale, the 'furrows' being about 2 m apart and between 70 and 200 mm deep. The surface of the allotments elsewhere was more or less flat except for a slight gully or depression a few centimetres deep which was detected about 6 m west of the beds. The land to the west of the gully had a very gentle upwards slope away from it. Thus three areas within Plot H were discernible, namely the beds, the area between the beds and the gully, and the area to the west of the gully. These must have either been separate allotments or separate areas within the same allotment.

The type of plant grown in the beds is obscure. Several soil columns were taken from within the beds and elsewhere in the allotments but these proved to contain little of value (Appendix 12, microfiche). No traces were found of trenches in the natural sand under the beds as would be expected for lazy-beds.

Professor S A Fashemski has suggested that this may have been a vineyard like those at Pompeii (pers comm). In modern vineyards, the vines are supported by wires which run the length of each row and are held taut by short stakes. No traces of such stakes were found at Balkerne Lane although this need not rule out this possibility. By coincidence, plots of asparagus are frequently interspersed with modern vineyards. These bear a strikingly close resemblance to the beds at Balkerne Lane (Fig 130, microfiche).

Other features found within the allotments included a timber-lined pit (VF471, Period 5) and a possible water-tank (VF422) (*see below*).

The volume of the material dumped over the allotments was so substantial that it probably derived from a widening of the nearby town ditch and was intended to form a counterscarp bank. If so, then the ditch was probably enlarged at the expense of allotments to the east of Site V. Certainly the composition of the dumped material was similar to what would be expected if cultivated soil and underlying natural sand were excavated to the depth of the ditch. Dating evidence for the event was substantial and was provided by the latest finds not only in the dumped deposits over the allotments but also in the cultivated soil. By their nature both contexts contained exceptionally high proportions of residual finds. The latest pottery in both, summarised in Appendix 10, falls within the bracket c 250-325. The latest coin found in the cultivated soil was of 268-70. The dumped soil produced many coins, the latest being of 270-3 (x 2) and 268-70. The dates of all the coins from the combined contexts are as follows: 43-64 (x 3), 64-8, 69, 69-79 (x 2), 72-4, 87-8, 117-37,

140-4, 161-80, 222-35, 228-9, 240-4, 268-70 (x 2), and 270-3 (x 2). In view of the small number of coins involved, the absence of coins of 294-330 is probably not significant since coins of this period are rare as site finds (see Fig 10, p 17). However coins of 330-45 are usually very common and their absence here must point to the dumping having taken place before the 330s. Also missing are the barbarous radiates usually dated to 270-90. Normally these coins are as common as those from within the range 260-73 so that their absence probably indicates that the dumping and hence presumably the widening of the town ditch occurred in *c* 275, perhaps within the critical period of 276-85 (pp 16-19).

### The dating of barbarous radiates

by Richard Reece

Regular coins from the official mints of the Empire are generally well dated because the authority which issued them, usually the emperor, appears on the coin and is well known in historical sources. Slightly less well dated are coins struck for a member of the Imperial family, sometimes an unspecified time after their death, but the changes of families and fashions seldom leaves these coins in chronological doubt. The one class of coin that needs further study is the local issue which copies an official coin. Barbarous radiates were produced in Britain and France, and probably further afield, from prototypes which were struck in Rome and Gallic mints between 259 and 274. A few very rare copies are known of issues of Aurelian and Probus (270 to 281), but nothing has so far been securely identified as a copy of a coin struck after 281 (Boon 1974). These copies ought therefore to date from any time after the most common prototypes had been produced, and the types copied are overwhelmingly of the Gallic Empire struck between 268 and 274.

The sequence of coins produced in Britain seems to extend directly from the production of copies of radiate coins minted in Gaul to the early coinage of Carausius, though some authorities would prefer to think of a break between the end of barbarous copies and the first coins of Carausius in 286-7. A problem here is whether to call irregular looking coins that are obviously related to Carausius by portrait and legend barbarous radiates or not. The general convention is to call these uncertain coins 'irregular issues of Carausius' and to assume that they belong early in the reign. These conventions fit well with the evidence, for the coinage of Carausius does improve demonstrably during the reign and there are very few 'irregular coins' of Allectus (293-296). My personal preference is to see the barbarous radiates merging into the early coinage of Carausius, so that official and full standard coins of Carausius when they develop kill the practice of striking irregular copies. If this sequence is correct then barbarous radiates are to be dated between the last issues of the Gallic Empire in 272-4 and the first regular issues of Carausius in 286-7, and hence the conventional dating '270-290'.

There is some evidence of sequence dating from archaeological deposits, though none of it is yet in print, or even in codified form. There are deposits

which have coins extending up to the years around 270, all of which are regular; later deposits have a mixture of regular Gallic radiates and barbarous radiates, but no issues of Carausius; later deposits have Gallic radiates, barbarous radiates and Carausius, and any of these coins may be represented in small numbers in hoards and site finds up to the end of coinage in Roman Britain around 400. After the issues of Carausius the next very common coins which reach virtually all deposits open to receive them are the issues of 330 to 345. The presence of the mint at London does not ensure that issues of 296 to 330 occur widely as site finds, presumably because of the intrinsic value of these silvered issues, so that their absence from any level is not a certain chronological indicator.

Likely date ranges for the groups that have been mentioned might be tentatively given as follows:

Gallic radiates alone	around 265 to 275
Gallic and barbarous radiates	from 270 to 290
Including Carausius	from 286 onwards until 330

Nothing is known as yet about the probability of concentrations of issues within the date ranges given, and no study has yet given good grounds for distinguishing between earlier and later barbarous radiates. It must also be stressed that the likelihood of any group of coins conforming to the dates suggested depends directly on the number of coins in the group, although ten coins together should be fairly reliable. Two factors should increase our understanding of the coins of this period in the near future. One is the study at present under way by John Davies of the University of Reading, on the typology and distribution of barbarous radiates. The other is the full publication of excavated coins in their stratigraphic groups, with the relationships between the groups, which unfortunately is still an archaeological novelty. ■

### The two possible water-tanks (Period 5)

[BKC Sites G & V; general plan Fig 102, p 113; detail plan Fig 104, Sheet 4b; general plan Fig 105, p 114; detail plan Fig 106, Sheet 5a; large-scale plan Fig 131, p 142]

Both consisted of shallow pits lined on the sides and bottom with clay 0.10-0.25 m thick. Inside the lining, the possible water-tank GF61 (Figs 104 & 131) was 3.2 x 2.0 m across and 0.45 m deep. The corners were rounded and around the edges of the base was a shallow slot as if there had been a timber-frame inside the lining. The possible water-tank lay on the south side of the London-Colchester street. Its eastern edge matched closely the eastern boundary of Plot A projected northwards indicating that the feature was probably linked with this property. The other possible water-tank (VF422; Fig 106) was smaller being internally 1.0 x 0.7 m across and 0.25 m deep. Like GF61, the corners inside the lining were rounded as if these had contained a timber-frame although there was no slot in the bottom. The pit was neatly aligned with the north boundary of Plot H and may have been against or close to a fence (Fig 112). The feature was probably a tank to supply water either for stock kept in part of Plot H or for plants in the allotments. In view of its position, the possible tank GF61 on the south side

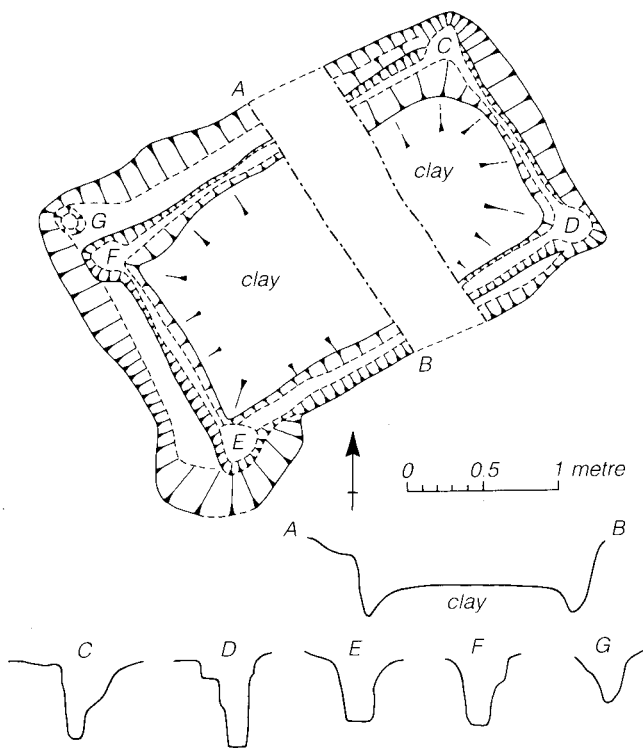


Fig 131 The possible water-tank (GF61) of Period 5. [Pages 141-2]

of the main street would have been more suited to animals, especially horses. The possible water-tank VF422 belonged to Period 5c; GF61 is certainly attributable to Period 5 and probably was in use during Period 5b rather than Period 5c.

### Plots I and J in Period 6

[BKC Site N; general plan Fig 105, p 114; detail plan Fig 106, Sheet 5a; large-scale plan Fig 127, p 137]

Despite the demolition of Buildings 64 and 65, there was still considerable activity in Plots I and J during Period 6 (Figs 106 & 127). The features concerned broadly resembled those in the middle of Plot A during Period 5c (ie post-pits and stake holes) except that there were also many small pits which clearly were too wide to have been for posts. The cellar (NF4/8) was being used as a convenient dumping area until at least the late 4th century (Sx 81, microfiche) and during Period 6 a ditch or gully (NF30) was dug along the boundary between Plots I and J. The post-pits and the many postholes made no clear patterns in plan and they probably represented several phases of fences. In Plot I, a group of stake holes was indicative of a modest structure of some kind. The deposits associated with Period 6 were largely of topsoil and it seems very likely that at this time the area north of the street was open ground.

### Plots A, G, and H in Period 6

[BKC Sites H, J, & V; general plan Fig 105, p 114; detail plan Fig 106, Sheet 5a]

No evidence was found of significant activity during

Period 6 along the strip of land on the southern frontage of the London-Colchester street (Fig 105). This is in contrast to Plots I and J (see above) and to the southern half of Plot A which became an area for dumping and sand quarrying (Fig 106). In some respects the latter was similar to the fate of the allotments on Plot H towards the end of Period 5 except that on Plot A the pit digging and the dumping were intermittent rather than of one phase which seems to have been the case on Plot H. In effect, the land from the middle of Plot A to the southern end of Plot H was waste ground during Period 6 with, as explained above, the dumped soil possibly providing a counterscarp bank for the town defences.

The southern half of Plot A was covered with light brown, homogeneous sandy soil which spread northwards to seal the floors of the south wing of Building 59 (Rooms 9 & 10) where it had dwindled to a thickness of a few centimetres. The southern part of Plot A was examined superficially mainly by narrow machine-dug trenches on Site J (T2-7) and a small hand-dug trench at the southern end of Site H (Fig 106). In both places complexes of intercutting pits were found which had destroyed the earlier stratigraphy. They were all filled with light brown sandy soil and thus were difficult to distinguish not only one from another but also from the spread of dumped soil which, in part at least, was a product of the pit digging. Few features of Period 6 were excavated. These included the bottoms of some shallow pits at the bases of the machine-cut trenches and a large, shallow pit (JF32) in the south-east corner of Site J (Fig 106). Although the western edge of the pit JF32 was difficult to detect, the eastern side was quite clear; this demarcated the eastern limit of the pit digging and coincided very neatly with the east boundary of Plot A. The other major feature of this period to be examined was a large sand pit (HF28; Fig 106) which cut the remains of Building 59 and the demolition debris over its floors. Unlike the other pits, it lay north of the spread of light brown sandy soil.

### Human burials (Plot A; Periods 5b-6)

The buried remains of at least 12 babies (approx) were found in the various contexts at Balkerne Lane. Only in two, possibly three, places were the bones found *in situ*, ie in Buildings 47 (TF73, p 118), 48 (TF58, p 118), and perhaps 61 (p 135); elsewhere they were residual in later contexts (Appendix 1, microfiche).

In the Period 6 sand-pit JF32 (Fig 106, Sheet 5a), a child inhumation lay in a lead coffin (Fig 132). The burial was not in its original position but had been disturbed in antiquity and reburied in the sand pit. The principal evidence for disturbance was provided by the position of the human remains in relation to the coffin and to the plaster which had been packed around the body (see report below). This conclusion is reinforced by the fact that the burial was in a large pit rather than a grave.

In a small pit (JF283, Fig 106) to the west of the coffin Sheet 5a; Appendix 8, microfiche) was part of an

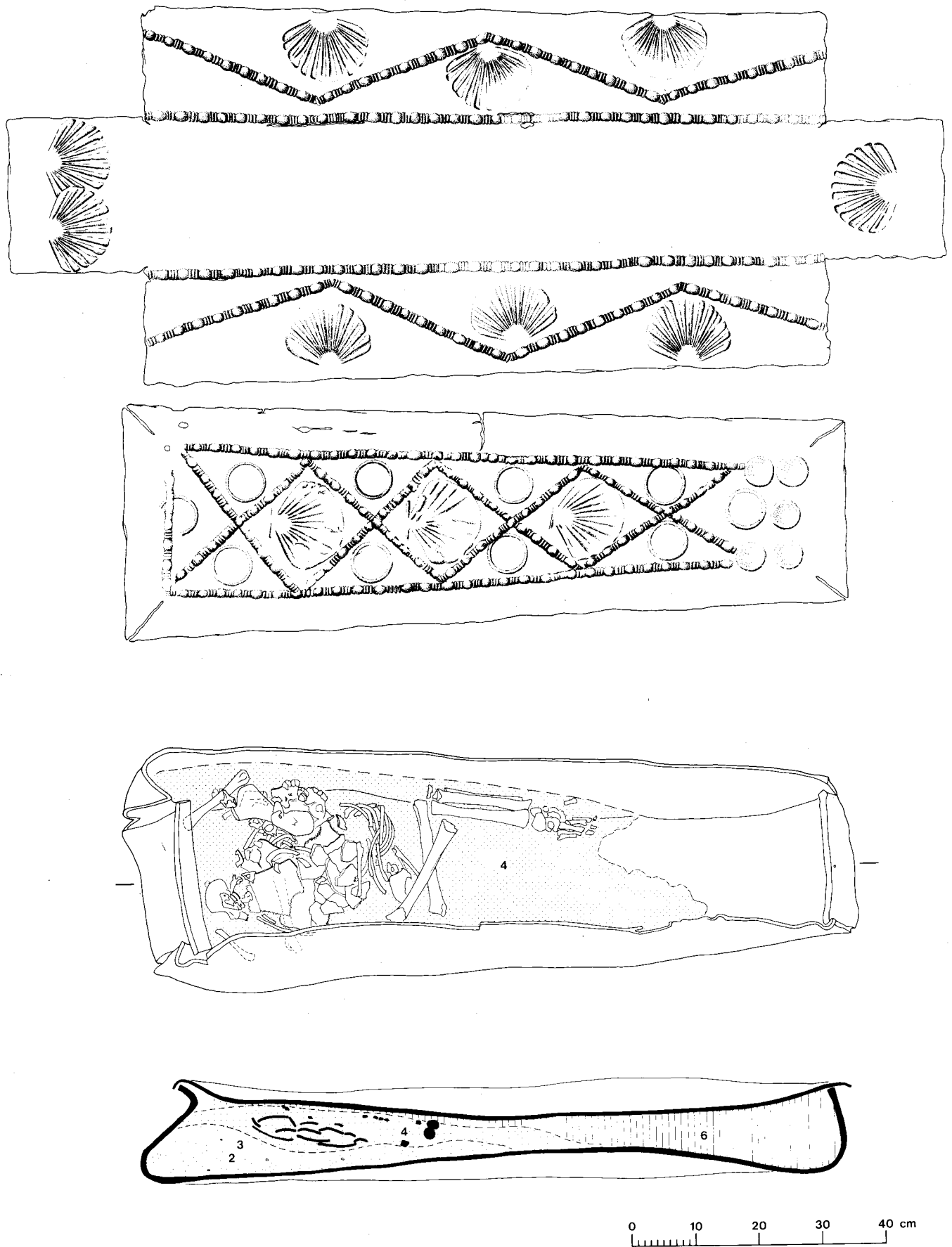


Fig 132 The lead coffin (Balkerne Lane, Site J) showing the decoration (above) and the position of human remains (below). [Pages 142-45]



upright amphora. This may have been a votive pot for which no burial was found. The site of another possible burial was found near the top of the Period 5/6 town ditch at Site E where a pit (EF436, Fig 106) 2.2 m deep was the size and shape of a grave. However no bones were found in it.

In the bottom of the Period 5/6 ditch on Site A, Trial Trench 5, an inhumation (AF47; Appendix 1) lay in a shallow grave about 0.6 m deep and appeared to have been without a coffin (Fig 133, p 144; location of trench shown in Fig 134, microfiche). The grave was dug shortly after the ditch was cleaned out for the last time. An early Anglo-Saxon context for the grave is likely since the appearance of a grave in the ditch suggests a period of neglect. Apparently burials have been found in the vicinity of St Mary's Hospital which is adjacent to the west side of Site A (Hull 1958, 255) so that the Site A inhumation may have been an outlier of this group.

The burial of babies within built-up areas is a phenomenon encountered not only at Balkerne Lane but at many places elsewhere and is explicable from historical sources which indicate that burials in these circumstances were permissible if the deceased were no more than a month or so old (Wheeler 1936, 138-9). Despite being much older, the child in the lead coffin does not conflict with this rule because the body had clearly been moved from its original place of burial. On the other hand, it may be that the burial of children and adults was permissible at Balkerne Lane when from the beginning of Period 6 the site became more open. This would certainly explain not only the coffin but also the inhumation in the bottom of the town ditch on Site A and the others to the west of it on the site of St Mary's Hospital if these were Roman.

### The lead coffin by Nina Crummy

[BKC Site J; Fig 132, p143]

The tapering lid of the coffin is decorated with a raised design framed on three sides (two long, one short) by bead-and-triple-reel moulding. This frame tapers to match the edges of the lid. On the second (narrower) short side are five solid circular motifs arranged to complete the regular outline of the frame. Within the frame the field is divided by criss-crossed bead-and-triple-reel moulding into lozenges and triangles.

Within each lozenge is a scallop shell and within each triangle along the edges are circular mouldings (see Toller 1977, fig 5 for these decorative elements). Each long side wall of the coffin bears a zig-zag of bead-and-triple-reel moulding with scallop shells in the triangles thus formed, and a strip of similar moulding along the junction of wall and base. The wider of the short ends bears two scallop shells and the narrower one shell. The shells on the coffin walls lack the basal cross-piece of the shells on the lid. All the shells are inverted from the point of view of a person standing at the foot of the coffin. Length 1026 mm, maximum width 250 mm, height 190 mm. ■

### The contents of the lead coffin (summary) by P M Barford

The following note is a summary of a detailed report given as Appendix 2 in the microfiche section of this publication.

The coffin was found, badly distorted, in a late Roman sand pit (JF32, Fig 106) and was not in its original place of burial. Excavation of the fill indicated that the body had been badly disturbed by the exhumation of the coffin and its subsequent dumping. Most of the remains were fragmented along the left-hand side and towards the head end of the coffin. The coffin fill consisted of dark soil, sand layers, and much fragmented plaster with impressions of textiles which had been around the bones.

It seems that the burial was of a child aged about five years. Probably there had been a pillow behind the head, but there were no grave goods. The body was packed in sand which was then covered with a capping of gypsum plaster. Two textiles were detected as impressions and as a small quantity of 'replacement' in the plaster. No large areas of body impression in the plaster could be reconstructed due to its badly fragmented nature.

Interpretation of this disturbed burial was difficult, but a careful consideration of the changes in burial environment, particularly as revealed by the corrosion products of the lead (seven types identified), led to the suggestion that the coffin had initially been interred in a situation causing only partial (possibly aerobic) decomposition of the corpse. A vault or mausoleum might have produced these conditions and the

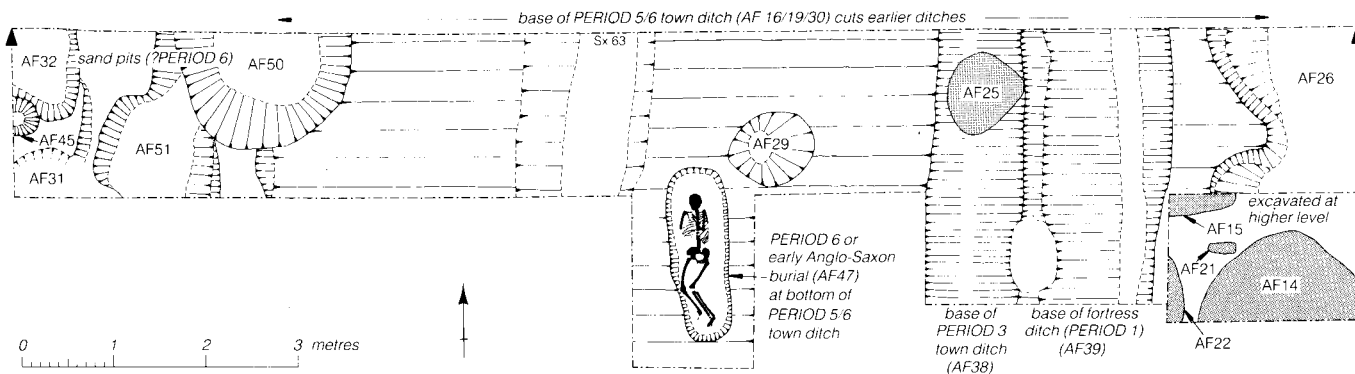


Fig 133 The burial in the bottom of the Period 5/6 ditch. The bases of the defensive ditches (Balkerne Lane, Site A), Trial Trench 5. [Pages 93, 115, and 144-5]

demolition or reuse of such a structure could provide a context for the exhumation of the coffin and the consequent disturbance of the body. The coffin was subsequently deposited in the sand pit where anaerobic burial conditions occurred and the coffin finally collapsed inwards after its wooden outer shell had rotted. ■

## The Period 5/6 defences

BKC Sites A, D, E, J, K, & M; general plans Fig 102, p113, & Fig 105, p114 & Fig 134, p231 (microfiche); detail plans Figs 103 & 104, Sheet 4b, & Fig 106, Sheet 5a; large-scale plan Fig 133, p144; Sx 65, Sheet 6b, Sxs 63 & 66, microfiche]

The Period 5/6 town ditch was examined at a number of points enabling the plan of the ditch in its latest form to be reconstructed (Figs 105, 106, & 133). The ditch was sectioned at various places (Sxs 63, 65, & 66), the most important being at Site D where a section (Sx65, Sheet 6b) across the ditch was removed mainly as a series of horizontal spits. Although several sections were dug across the ditch on Site A (in most cases these were only partial sections), none proved to be as useful as that on Site D. Trial Trench 5 in Site A (Figs 133-4) was laid out across all three town ditches (ie of Periods 1, 3, & 5/6) but only the lowest 1.0 to 1.7 m of them survived (Sx 63, microfiche) because in places the ground level had been reduced by up to 2 m in the 19th century when the steep slope in this part of Balkerne Hill was terraced for a new house.

The ditch was about 15 m wide and 3.75 m deep. From the end of Period 6 to late Anglo-Saxon times, the ditch gradually silted up with an accumulation of topsoil and intermittent, small-scale dumping. The latest sherd was 0.9 m from the top of the fill of the ditch (Sx65) and is probably of middle Saxon date (*CAR* 1, 17-8, fig 21). At the time of writing this report, this is the only post-Roman sherd recognised in the ditch fill although a few more may come to light when the thorough analysis of the pottery is completed. The earliest topsoil in the ditch fill was distinctly lighter than that higher up. In Site D, much of the lighter material lay in thick irregular patches on the sides and bottom of the ditch giving the impression that the ditch had been cleaned out at least once and that the lighter soil was silt which had not been removed during these operations.

The plan of the ditch in its final form points to several phases of enlargement. The length of ditch across the main London-Colchester street was narrower than the ditch elsewhere and thus reveals where the butt ends of the previous phase had been. The north butt end had already encroached on to the main street apparently reducing its width by about 7 m and both butt ends were wider than the rest of the ditch to the north and south.

Unfortunately it is impossible to determine the width and profile of the original ditch as set out at the start of Period 5a. The dumped soil on Plot H suggests that it had been substantially widened towards the end of the 3rd century. To the north of the Romano-Celtic temple and to the south of the possible shrine, there was a gap 23 m wide between the eastern edge of the ditch and the north-south street. This mirrored closely the arrangement in Period 3 because the positions of the

street and the eastern edge of the ditch of Periods 5/6 coincided with the positions of those of Period 3. This correspondence is striking and could be taken to imply that the Period 5/6 ditch was in reality the Period 3 ditch enlarged on its west side (p115).

## Two small ditches of Period 6

[BKC Sites D, E, K, & U; general plan Fig 105, p114; detail plan Fig 106, Sheet 5a; large-scale plan Fig 115, p124; Sx91, microfiche]

One of the ditches (Fig 106; DF46/EF29/EF65/EF357/KF15) was traced for 78 m. It was placed along the eastern edge of the Period 5/6 ditch so that it passed along the foot of the possible shrine (Building 53) and the *cella* of the Romano-Celtic temple (Building 52). The ditch clearly post-dated the robbing of the foundation of the ambulatory of the Romano-Celtic temple since the ditch crossed the robber trenches of the north and south walls. The robber trenches were Roman and were no earlier than the mid 4th century (p125). The ditch varied in depth between 0.5 and 0.8 m. Like all the latest Roman levels, the upper part of the ditch had been destroyed so that its original depth could not be established although it was probably not much deeper than as found. The ditch was at its shallowest in the middle of Site E with the effect that the bottom of the ditch sloped downwards to the north and south of this point.

The second ditch (UF1; Figs 106 & 115) stopped close to the ambulatory wall of the Romano-Celtic temple and was placed alongside the eastern edge of the Period 5/6 ditch. The feature was discovered in the side of the contractor's trench when the bulk excavations for the new road were well under way. It was sectioned in two places (Sx 91, microfiche) and found to be a U-shaped ditch, approximately 1.6 m wide and 1.4 m deep.

The purpose of the ditches is obscure but a defensive role seems the most likely. They appear to have been left open, in which case they would not have been palisade trenches. It is unlikely that both ditches were conceived of as part of the same scheme and thus laid out at the same time. Their profiles are different and one ditch post-dated the demolition of the outer wall of the Romano-Celtic temple whilst the other seems to have predated it.

## Latest levels on Site M on the north side of the London-Colchester street

[BKC Site M; detail plans Fig 104, Sheet 4b, & Fig 106, Sheet 5a]

Two trial trenches (Figs 104 & 106) were dug across the latest surviving Roman levels on Site M which consisted of brown sandy loam with patches of gravel and oyster-rich soil. No evidence of buildings was found although a timber-framed structure without foundations or mortared plinths could perhaps have escaped detection. The trenches were dug quickly by hand without layer by layer excavation. At the south end of the longer trench was street gravel. The rest of it contained layers of loamy sand and oysters to a depth of about a metre as at Sites E and K during Period 4. The shorter trench was excavated to a depth of only 0.5 m;

the stratigraphy was similar to that in the middle and northern parts of the other trench.

### Latest street metalling over town ditch

[BKC Site M: general plan Fig 105, p 114; detail plan Fig 106, Sheet 5a]

A thin but firm layer of metalling made of gravel, small stones and tile fragments (Figs 105 & 106) was laid over the silted up short stretch of ditch which a considerable time earlier had been dug across the main street. At its thickest, the metalling was 0.1 m deep. In the limited area exposed, the street seemed to have been slightly cambered and dropped 0.35 m in height over a distance of 3.4 m. The latest Roman levels were clearly missing over all of Site M. The metalling had subsided slightly into the fill of the town ditch and had been destroyed at its highest point where it had risen to overlap the western edge of the ditch.

The metalling contained a coin of 335-7 whilst in the pea-gravel above were two coins of 270-90. Mid to late Period 6 is the obvious context for the metalling although there is the problem of the underlying ditch silt which elsewhere is taken to be of post-Roman origin (p92). There is however from Site D evidence that in the Roman period topsoil did accumulate in the bottom of the ditch and that this was cleared away at least once in Roman times (*see above*). Perhaps the metalling was laid out at a time when there was much silt in the ditch but before the cleaning out operation detected on Site D. The alternative explanation is that the metalling is post-Roman, perhaps of late Anglo-Saxon date. If this were the case, then probably the street would have survived to medieval times or later but there is no evidence of this. A late Roman context seems much more likely.

### Building 66 (Roman)

[BKC Site R: general plan including site location Fig 135, microfiche; piles F136, p146]

Part of a Roman building (Fig 135) was found when the contractors dug a large hole for a new subway at the foot of Balkerne Hill in 1976. The ground at the bottom of the trench was waterlogged and the remains consisted of some perfectly preserved wooden piles still *in situ*. A group of these lay close to the south edge of the trench where part of a mortar foundation projected from the section. The deposits which survived at the foot of the trench all predated the building by some considerable time and seemed to have consisted of an accumulation of layers of waterlogged topsoil mixed with organic material. A small trench 2.0 x 2.5 m around the group of stakes was carefully excavated. Some samples were taken and parts of the sections (Sx 82, microfiche) on the east and south sides were drawn. The largest of the piles was 80 mm across and 0.7 m long (Fig 136). They had been driven into the bottom of the foundation trench like those at Building 53 and were intended to make the foundation more stable. The species of the wood could not be identified because its structure is

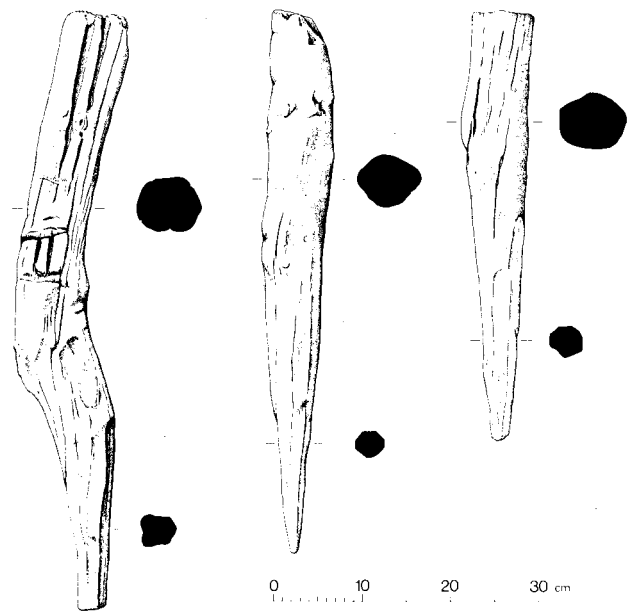


Fig 136 The wooden piles at Building 66. [Page 146]

obscured by chemicals used during conservation. The foundation itself, although much damaged, survived to a depth of 0.4 m. No floor levels were found but the highest surviving Roman levels (Sx 82) were about 0.8 m above the tops of the piles giving some indication of the original depth of the foundation.

The circumstances of the discovery were such that little is known about the plan of the building except that it almost certainly extended south of the trench. Building 66 lies north-east of the remains of at least one Roman building found in the early 19th century at the Colchester Waterworks. Pavements and foundations are recorded as having been uncovered and contemporary accounts in a newspaper talk of Roman baths with 'earthen pipes for the letting in and out of the waters' and a pavement with some well preserved oak 'framing' (Hull 1958, 242-3). This is plausible in the light of Building 66, although these early discoveries seem much more substantial than those of 1976 even allowing for the limited nature of our own examination. The exact location of the 19th-century discoveries within the Waterworks site is not clear. According to the newspaper reports already mentioned, 'nearly the whole of an extensive field' was involved and it is thus just possible that, despite being about 25m from the main buildings of the Waterworks, Building 66 may have been part of the same complex. Clearly there were significant Roman buildings in this area of the town but, as the western half of the Middleborough site has shown (p155), there were also large open spaces.

### The wall plaster from Balkerne Lane

by Roger Ling

Most of the fragments of painted plaster from the Balkerne Lane site are in small residual groups and merit no special comment; there is too little either to

enable reconstruction or to justify statistical analysis, and there are no traces of figural or vegetal decoration. But the material from two buildings is of greater interest.

### Building 51

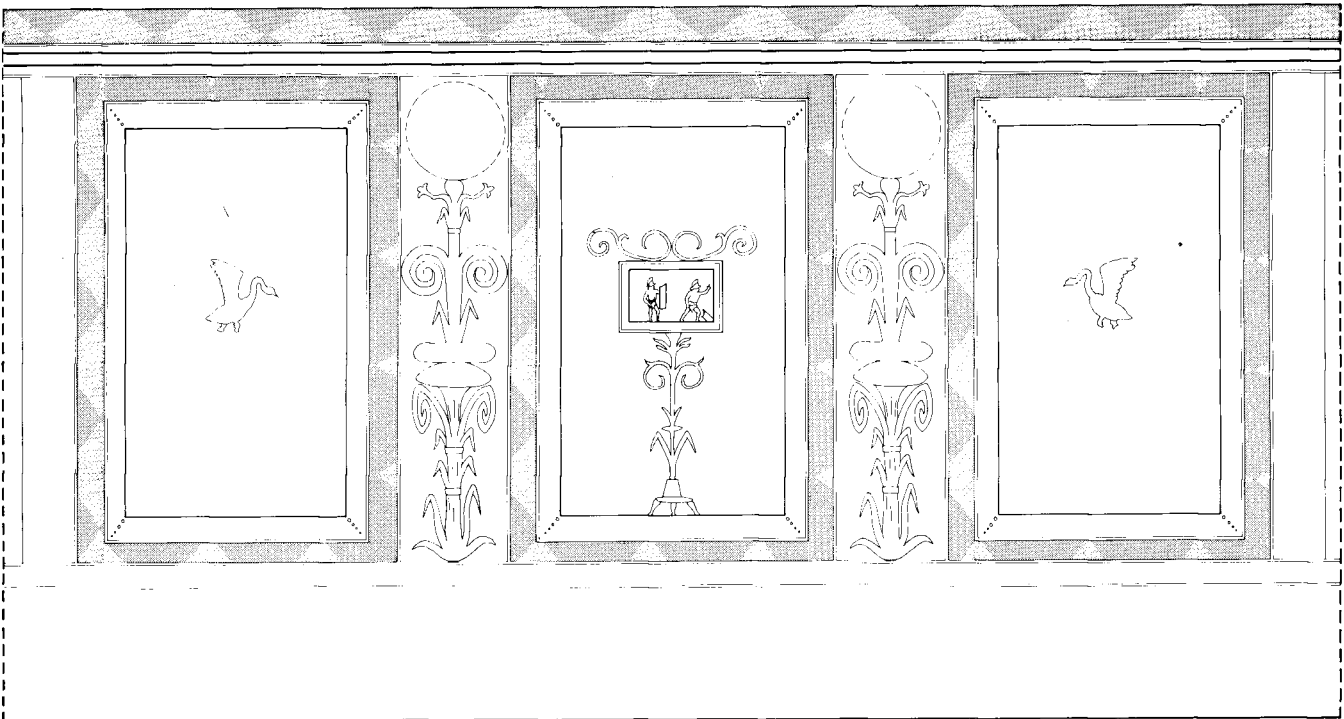
[Conjectural reconstruction Fig 137, p 147; fragments Figs 138-42, pp 148-52]

A relatively large deposit of collapsed plaster was found in Room 2 and clearly belongs to a single decoration. Enough of the fragments can be reconstructed for us to make an educated guess as to the scheme (Fig 137).

The main element was a series of large pinkish red fields framed by black borders (from 50 to 75 mm wide) and separated by vertical fasciae (approx 0.33 m wide) containing vegetal candelabra on a background of the same pinkish red (Fig 138). Underneath this scheme ran a dado of the normal imitation marbling, with splashes of black on a light pink ground (at least 0.235 m high), surmounted by a border (approx 60 mm wide) of mustard yellow, which, like the black borders of the red fields, is set between white stripes. At the top of the scheme ran a horizontal band (approx 90 mm wide) with two black stripes widely spaced on a white ground, and above this another zone of black. The same fragment that shows the upper zone (Fig 139.2) also reveals that the red fields had an inner frame consisting of a white line set from 55 to 72 mm in from the edge (cf Fig 139.1); the outer corners of this frame, as often in Romano-British wall-painting, were embellished with a diagonal series of spots.

The candelabrum was executed in pink, white and cream, with reed-like leaves growing from its stem. At the top of the reconstructed section the stem swells into a broad calyx, upon which rests a plate seen in perspective; such plates are a familiar feature of painted candelabra, and the only unusual feature here is the series of oblique pink lines with which the plate is decorated. Several smaller fragments (Fig 140.1-4 & 10) may also perhaps be assigned to this, or a similar, candelabrum. Two pieces show parts of cream and orange volutes which may have grown from either side of the stem (Fig 140.1-2), and another piece carries a pink flower on a tendril which may also have been an offshoot from the parent plant (Fig 140.10). Small fragments representing a fish or fishes with white belly, pink upper side and dark red scales (Fig 141.7-8) and a cluster of round green fruits (grapes?) with white highlights (Fig 141.12) could belong to the candelabrum fascia, but if so it is difficult to understand their precise role. The fish in particular, painted against pink and cream forms on a red background, seems well and truly out of its element: normally one would find it in a sea-food still-life or swimming in an all-over marine decoration.<sup>1</sup>

The most interesting fragments derive from rectangular panels containing duelling gladiators on a green ground. In the most complete, which shows the lower right corner of a panel, a defeated gladiator equipped with arm-guard, greaves, crested helmet, belted loin-cloth, and narrow-bladed sword of the *hoplomachus* (?) moves in three-quarters view to the right raising his left hand to petition for mercy (Figs



R.J.L

0 1 2 metres

Fig 137 Conjectural reconstruction of wall plaster found in Building 51 (Roger Ling); black borders shaded. [Pages 147-53]

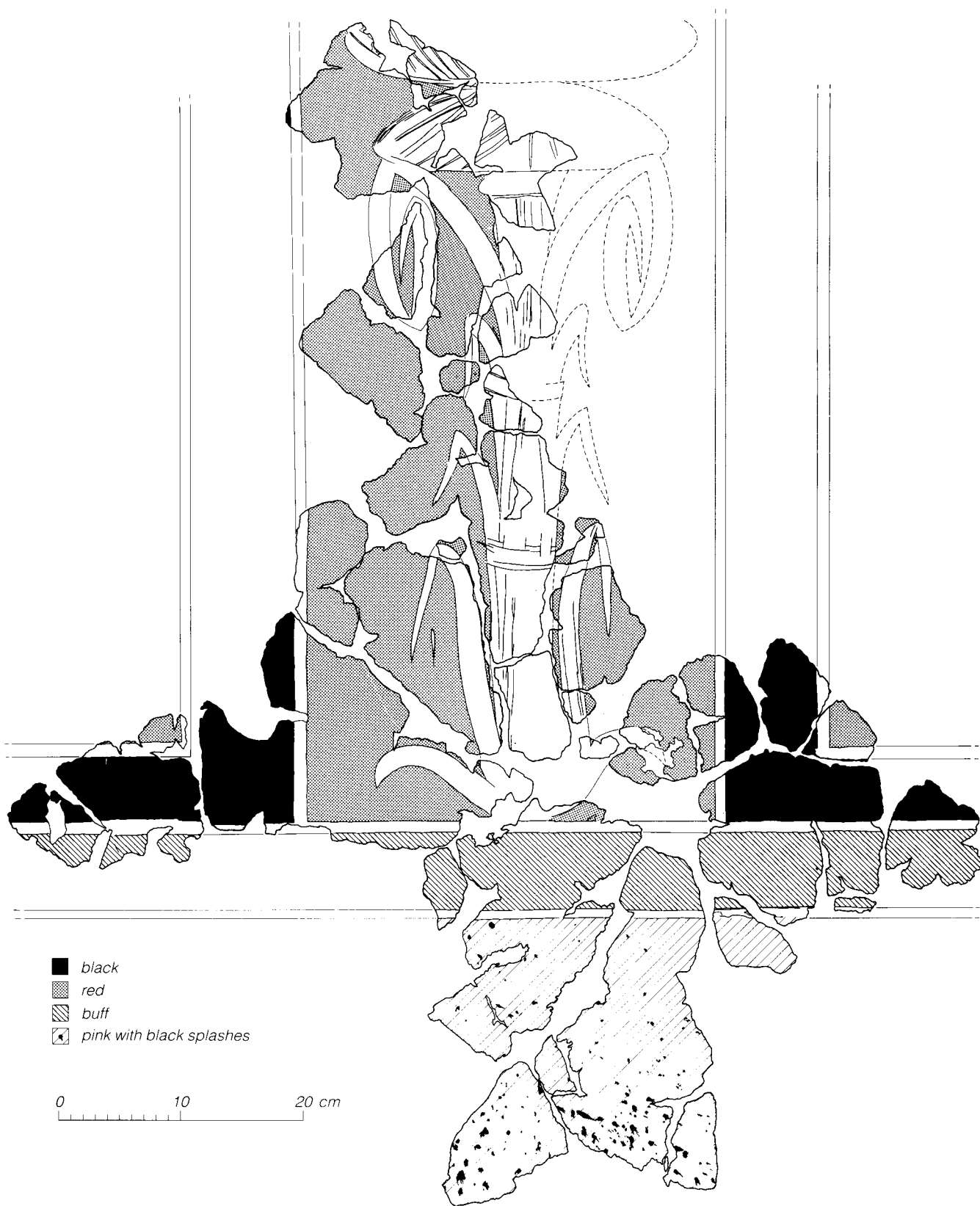


Fig 138 Wall plaster from Building 51 (vegeta candelabra). [Pages 147-53]

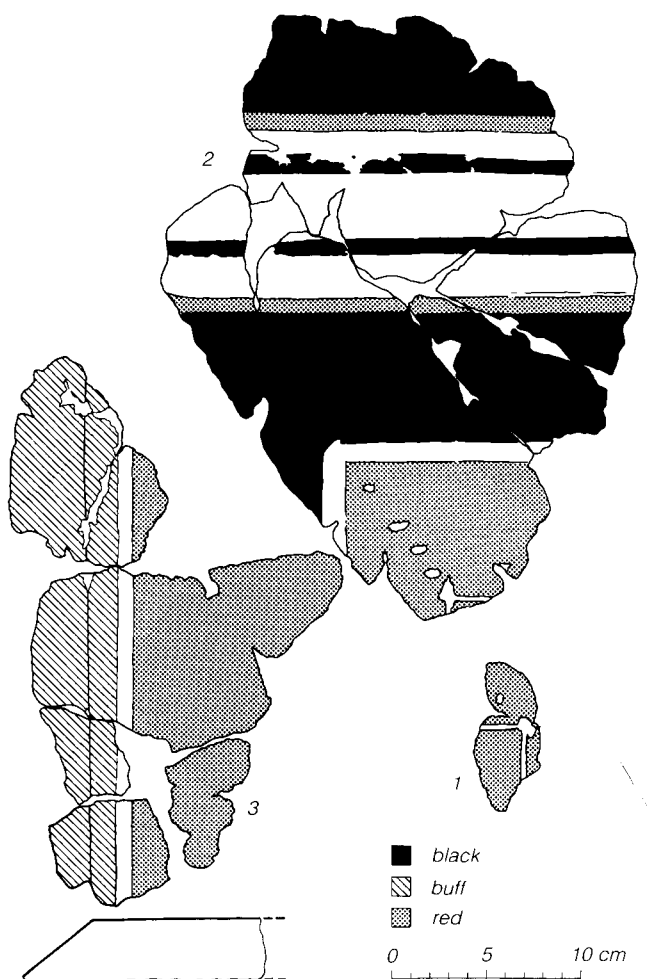


Fig 139 Wall plaster from Building 51. [Pages 147-53]

141.4 & 142). He has dropped his semi-cylindrical shield, which lies on the ground in front of him, but still holds his weapon, dripping blood, in his lowered right hand. The figure, only 125 mm high, is delicately rendered in shades of red and pink with the armour overpainted in yellow and white; the outlines, eg of the raised arm, are brownish red, and the sword is black. The exterior of the shield is white with a rectangular frame in red and yellow; the interior is pink.

Parts of at least one other gladiator have survived (Fig 141.2-3). Two joining fragments (Fig 141.2) show the back of the head, right shoulder and torso of a figure armed in similar fashion to the first and again represented in three-quarters view to the right; this time, however, the sword and the semi-cylindrical shield are held in readiness for an opponent's thrust. Two further fragments carrying the forward edge of a similar shield (Fig 141.3) may belong to the same figure, but more probably derive from a third gladiator whose body is missing.

The state of alertness of the second gladiator implies an opponent who has not yet succumbed, and so probably not the defeated *hoplomachus* of Fig 141.4 (though for convenience they have been combined in the reconstruction drawing, Fig 137). If we assume that the shield of Fig 141.3 belongs to a separate figure, he too was in a state of readiness, and, since the perspective indicates that he was facing to our right,

we would have to postulate at least three distinct pairs of duellists. The question arises, what role did they play in the decoration?

Only the first gladiator can be linked to a panel-frame (Fig 141.4). This consists, at the bottom, of stripes in four main colours: from inside out, brownish purple (5 mm), yellow with a white highlight (15 mm), orange (8 mm), and dark red (5 mm). The frame at the right is similar, except that the yellow stripe is narrower (12 mm) and the positions of the red and orange are reversed. The whole panel has been painted over the pinkish red which is the background colour both of the main fields in the decoration and of the candelabrum fasciae; which would suggest that it was set either on top of one of the candelabra or at the centre of one of the main fields. The measurements would be appropriate to either position. The surviving height of the panel (158 mm internally) probably falls very little short of the original height, since otherwise the gladiator would be disproportionately small; the width, assuming that only one pair of duellists was shown, would have been about twice the width of the surviving pieces, thus about 260 mm. This would fit comfortably in one of the candelabrum fasciae, and it would also tally more or less with the measurements of similar non-mythological panel-paintings within the main fields of roughly contemporary Pompeian decorations, for example those of the *alae* (before AD 62), *fauces*, peristyle, and bedrooms *g* and *k* (probably after 62) of the House of the Vettii, where the subjects are still-lives and animal-scenes.<sup>2</sup>

Further potential light on the position of the panels is shed by indications outside the frames. There are traces of white paint on the red ground beneath the panel in Fig 141.4; and on another fragment which appears to show a corner of a similar panel (Fig 141.1) a yellow and orange tendril grows from the outer edge. The panel-frame on this second piece is simpler than on the piece already discussed, since it lacks the outer stripes of orange and dark red; and it is possible that we are here dealing with the upper edge of the panel, in which case the tendril may be one of a pair of symmetrical volutes resting above it. This would at first sight suggest that the panel was set in or on one of the candelabra. But there is no true parallel in Roman painting for an independent figured panel set in this position; the similarly placed scene of vintaging Cupids in a painted decoration from the Cathedral excavations in Cologne<sup>3</sup> has neither an independent frame nor an independently coloured background. Another position where figured panels are sometimes supported or framed by tendrils in Pompeian painting, especially in the Third Style, is the upper zone of the wall; and here, indeed, an independent colouring is occasionally used<sup>4</sup>; but there is as yet no evidence in Britain for elaborate upper zones and, under the circumstances, it would be rash to argue for one at Colchester when the evidence is so exiguous. All things considered, the most likely position for a finely painted figure-panel remains the centre of the red field; in which case one must assume that there was some form of supporting or framing volute-ornament superimposed on the field—a motif which is extremely unusual, but for which vague parallels can be found.<sup>5</sup>

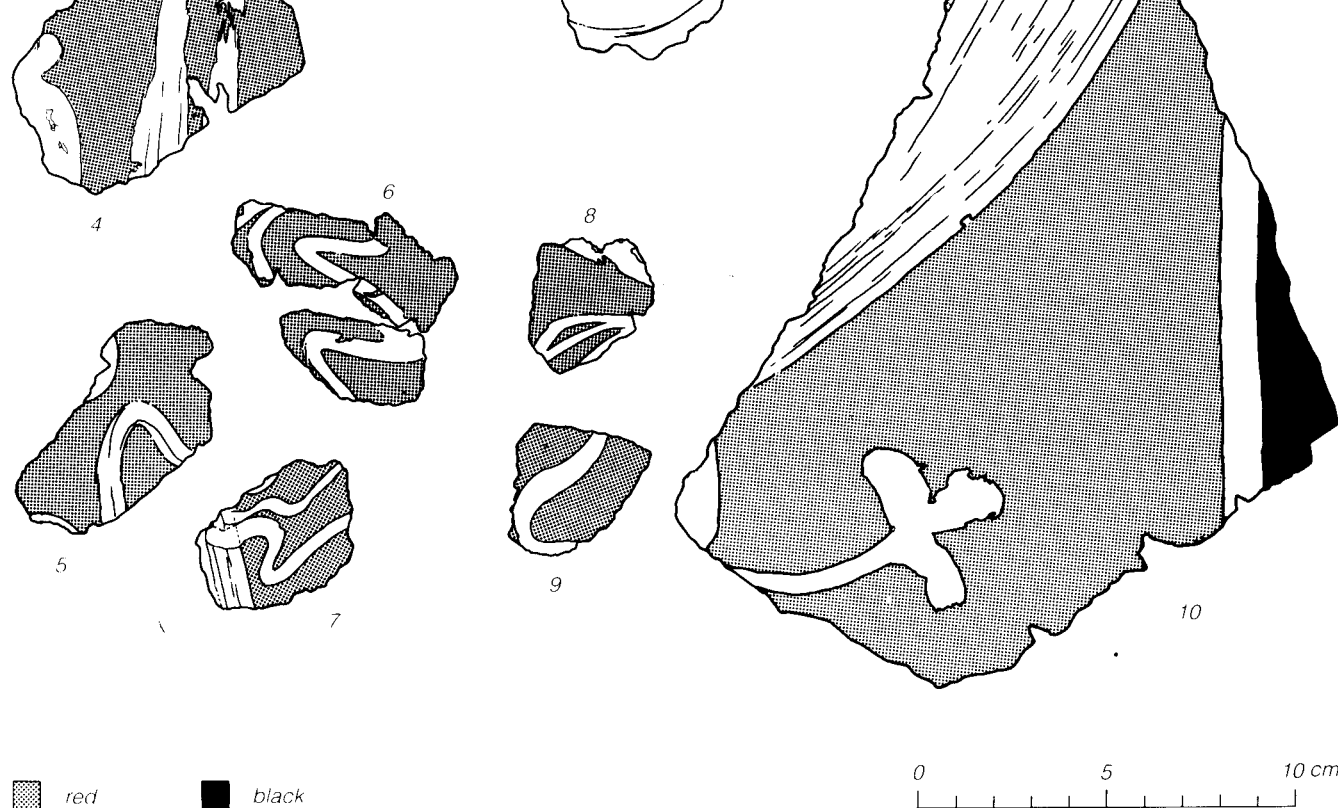


Fig 140 Wall plaster from Building 51. [Pages 147-53]

One other figured fragment can be recognised; it shows the rear part of an animal-pawed swan, its wings raised, on a red ground (Fig 141.15). This could be one of a pair of such creatures posed back to back on side-shoots of the candelabrum, a familiar motif in the decorative arts<sup>6</sup> but, since there is no trace of vegetal decoration beneath the feet or behind the back, a more probable position is again the centre of one of the red fields. Swans are often found as central emblems of fields in Pompeian painting, particularly in the side-fields of compositions where the central field contains a figured panel.<sup>7</sup>

Working from the data discussed above it is possible to postulate a scheme of the type illustrated in Fig 137. Assuming that the main fields were three times the width of the candelabrum intervals, we can restore three of them on the short walls (4.10 m long), of which the central one carried a panel with duelling gladiators, and those at the sides a flying swan. On the long walls (minimum length 5.40 m) there would have been space for either four fields, or (more probably, in view of the Roman preference for axial-symmetrical schemes in enclosed rooms) some kind of five-field arrangement in which the outer fields and intervals



Fig 141 Wall plaster from Building 51. [Pages 147-53]





Fig 142 *The painted gladiator from Building 51.* [Pages 147-53]

diminished in width. Again the central field would have contained a gladiator-panel and the outer ones a swan or similar emblem. The scheme must of course have been interrupted by at least one door; there is indeed an assemblage of fragments showing a door- or window-reveal painted in orange, apparently opening through one of the basic red fields (Fig 139.3).

Our reconstruction is merely hypothetical and does not account for all the fragments, for example those with what appear to be waving fillets or ribbons (Fig 140.5-9). But without fuller evidence it is unprofitable to speculate further; we must be content with a proposal which accommodates the larger and more distinctive elements.

The standard of workmanship is high, as usual in the 1st century; the plaster is well smoothed and the colours evenly applied. Particularly fine are the figures of gladiators, which have been executed by an artist of no mean skill, quite probably at this date an immigrant from the continent. Whatever his origins, he was using purely classical figure-types: the gladiator pleading for mercy is paralleled, for example, in a stucco relief at Pompeii (mid 1st century)<sup>8</sup>, in a terracotta relief, perhaps from Cuma, now in Brussels (date uncertain)<sup>9</sup>, in a mosaic from Zliten in Tripolitania (late 1st or early 2nd century)<sup>10</sup>, and in a type used on central-Gaulish *terra sigillata* (2nd quarter of the 2nd century)<sup>11</sup>. Similarly the gladiator with sword and shield at the ready is a familiar type, found for example in reliefs from central Italy and Asia Minor, though often with the shield held closer to the body.<sup>12</sup> But, however standardized the types, it is unlikely that a house-owner would have commissioned a wall-decoration involving gladiatorial scenes unless he had some personal familiarity with, or enthusiasm for, the entertainments of the amphitheatre. Perhaps he was himself an immigrant to Britain; or perhaps he had actually witnessed gladiatorial games in the province. At all events our paintings join with other evidence from Colchester, notably the 1st-century imported glass bowls from the Sheepen site<sup>13</sup> and from Balkerne Lane itself<sup>14</sup>, the late 2nd or early 3rd century 'Colchester vase' and others like it<sup>15</sup>, and possibly the enigmatic terracotta relief drawn by Josiah Parish<sup>16</sup>, in attesting a lively local interest in the amphitheatre. As such they deserve attention for their sociological connotations as much as for their artistic quality.

## Building 59

[Fragment Fig 143, p153]

This building, datable to the 2nd century, yielded abundant remains of a decoration with delicate foliate candelabra on red fields. The foliate forms are rendered in white, yellow, and green, and, though the remains are very fragmentary, one can recognize the ends of white tassels hanging from a garland and the stem of a yellow candelabrum with leaves growing from either side. One piece (Fig 143) shows a two-pronged yellow 'stand' supporting what appears to be a white disc or 'flower' with knobles round the rim.<sup>17</sup> All these elements are characteristic of a system of ornamentation found in several Romano-British wall-

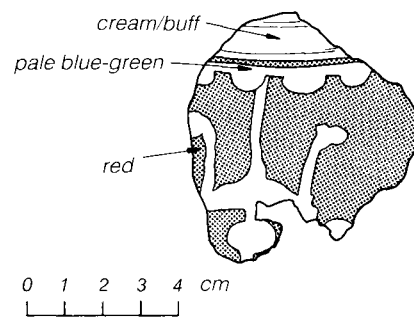


Fig 143 Wall plaster from Building 59. [Page 153]

decorations broadly dated to the 2nd century AD, eg at Leicester (a courtyard-house in *Insula XVI*), at Verulamium (House XXI, 2), and at Winchester (Woolworth extension site)<sup>18</sup>. It consists of an alternation of large red fields and black intervals, in which each red field is decorated with a pair of lateral candelabra, linked at the top by looping garlands. Larger and better preserved fragments of a similar decoration were recovered in the early 1960s from excavations by Bryan Blake near the Balkerne Gate.<sup>19</sup>

Otherwise there were various fragments of linear elements and panel-decorations in pink, red, white, black, and (occasionally) yellow; but, in view of the comparative smallness of the deposits and the difficulty of assigning them to individual rooms within the building, it has not seemed worthwhile to prepare any statistical tables.

## Notes

1. Croisille 1965, pls 21-43; Kapossy 1966, *passim*, esp 39-41; Davey & Ling 1982, 156.
2. Peters 1977, figs 3, 4, 59-61, 64, 65, & 70.
3. Linfert 1973, 70, pl 18.1.
4. Eg Schefold 1962, pl 10, fig 1, pl 40, pl 42, fig 2; Bastet & De Vos 1979, pl 49, fig 86, pl 50, fig 88.
5. Eg Bastet & De Vos 1979 figs 9, 11, 12, pl 21, fig 41, pl 31, fig 57; cf Kraus 1967, pl 169.
6. Eg Barbet 1974, fig 5.
7. Cf Schefold 1962, pls 131 & 141; Peters 1977, fig 37; Bastet & De Vos 1979, fig 15.
8. Mazois 1824, pl 32, fig 1, extreme right.
9. Faccenna 1958, pl 8.2.
10. Aurigemma 1926, 159, fig 94.
11. Oswald 1937, pl 49, no 1047.
12. Faccenna 1958, pl 4, second figure from the right; Robert 1940, *passim*.
13. Hawkes & Hull 1947, 299-300, pl 86.1.
14. Site T; Price 1977, 152.
15. Toynbee 1962, 190, no 158, pls 176-7; Hull 1963, 91-8, figs 50-3.
16. A forgery?; Hull 1958, 170, pl 30.A.
17. For the pronged 'stand' supporting a 'flower', cf Davey & Ling 1982, fig 25, pls 49, 50, & 123.
18. Davey & Ling 1982, 123-31, no 22; 171-5, no 41 A-C; 194-6, no 47; cf 153, no 32 (Scampton).
19. Unpublished but on display in the Colchester and Essex Museum. ■

## The post-Roman remains

Apart from topsoil and the fill of the Period 5/6 town ditch, no post-Roman features or layers were found on the Balkerne Lane site which were earlier than the 17th or 18th centuries and it can thus be concluded that between this date and the end of the Roman period

the area was given over to fields or allotments. This is in keeping with the earliest plans of Colchester which show that Balkerne Lane, Balkerne Hill, Pope's Lane and the first houses along their frontages originated after Speed's map of Colchester (Speed 1610) but before Morant's plan (Morant 1748). Speed's map seems reliable since it accurately shows the course of the spring which rose at the foot of what was to become Balkerne Hill. In contrast to the extra-mural site at Middleborough, the inactivity at Balkerne Lane is underlined by the absence of any medieval robber trenches and the consequent survival of the foundations of Buildings 52, 59, and 60 (except where robbed in the Roman or modern periods).

Most of the gravel which made up the London-Colchester street was robbed out in the 17th or 18th century by means of large gravel pits. These were found on Sites E, G, and M. Trial Trench 1 on Site G was parallel to a modern property boundary just to the west (Fig 106, Sheet 5a). The western side of the northern half of Trench 1 coincided with the western end of a large gravel pit thus suggesting that the boundary existed when the pit was being dug. The earliest post-Roman building encountered during the excavation was on Site E where some brick foundations were found which belonged to the house shown at the corner of Balkerne Lane and Pope's Lane on Morant's plan of Colchester.

---

# EXCAVATIONS AT MIDDLEBOROUGH 1979

by Howard Brooks and Philip Crummy

---

## Introduction

[MID general site plan Fig 144, p 156]

The site lay on the southern edge of the river Colne, between the Roman town wall and the river (Fig 1, p1). Ground levels before excavation were 8.5 m above Ordnance Survey datum on the south-east side of the site and 7.1 m on the north-east side. The eastern half contained a Roman street and buildings which dated from about the late 1st century and had previously been unknown. The remainder of the site had been covered with topsoil and, probably because of the high water-table, had seen little occupation of any period except near the street. The latter had continued along the north side of the site where on its southern frontage there had been a pottery kiln in the 1st or early 2nd century.

The excavation was confined to the east side of the site (p1), the nature of the remainder being established primarily by some barren machine test pits (Fig 144) and a geophysical survey prepared for the developers. The part of the site where the ground disturbance was expected to be at its greatest was on the west side where a large basement was planned. The area concerned was not excavated by archaeological means beforehand but, as indicated in the trial trenches, it proved to be sterile except at the north end where the pottery kiln was encountered.

Some limited trial trenching was carried out on the adjacent site to the north where, as part of the same redevelopment project, it was proposed to build a multi-storey car park (Fig 144). A note about this work is given at the end of the report (p 209).

## Summary of the archaeological remains (late 1st century to 1978)

[General site plan Fig 144, p 156]

Apart from the street, a kiln and some wells, the Roman remains are described in terms of three periods. These derive from the development of Buildings 67, 69, and 70 which all shared the same plot (Fig 144). To Period 1 belonged Buildings 67 and 68. It began in the late 1st century and ended with the demolition of Buildings 67 and 68 during the early to mid 2nd century. No evidence was found of occupation earlier than Period 1 although, because of the limited nature of the excavation, this possibility cannot be ruled out. At the start of Period 2, Building 69 replaced Building 67 and perhaps Building 68. In c 150, the first phase of Building 70 was constructed incorporating parts of Building 69. The dates of the construction of Buildings 71-3 are not known but all the buildings including Building 70 appear to have been demolished in c 300 at the end of Period 3. The pottery kiln

belonged to the Flavian-Trajanic period whilst three timber wells (or at least the only one to produce dating evidence) were of mid-2nd- to 3rd-century date. The earliest post-Roman remains were four inhumations possibly of the 10th or 11th centuries. The foundations of the Roman buildings were extensively robbed in the 11th and 12th centuries. A series of pottery kilns was in use in the 12th century and was possibly contemporary with the post-built structure Building 74. In about the 14th century Buildings 75 and 76 were built on the street frontage. Subsequently both were much altered. A substantial part of the timber-frame of Building 76 survived until its demolition in 1978. This was recorded in detail and can be reconciled with the archaeological remains which underlay it.

## Buildings 67 and 68 (Period 1)

[General plan Fig 146, p158; detail plan Fig 145, p157]

Building 67 (Figs 145 & 146) was a timber-framed building erected in the late 1st or early 2nd century. It was presumably a strip-house only part of which was uncovered. The building was of two phases (Periods 1a & 1b). Shallow slots (F957-9, F980, F988, F991, & F997) indicated the positions of the ground-plates which had all been surface-built without foundations. Occupation layers of Period 1 were observed in section about 7 m west of the excavated area indicating that Building 67 had extended at least this far west.

### Phase 1 (Period 1a)

Room 1 contained two post-pits (F998 & F999) which probably were of secondary origin. Both were packed with broken tile and fragments of greensand and both had their posts removed when the building was altered in Period 1b. Rooms 2 and 3 each contained a hearth (F993, Fig 147, p 159) built on a single tile against the centre of the west wall of each room. Room 4 may not have been a proper room but a platform of some kind on the street frontage. It was a small compartment with at least two internal slots (F981/2 & F983/4) possibly indicating joists and thus a wooden floor. The relationship between the pit F955 and the slots was unclear because the stratigraphy had been distorted by subsidence into the pit. The joists may have sealed the backfilled pit and been intended to counteract the effects of settlement, or the digging of the pit may have post-dated the removal or decay of the joists. The southern end of the east wall of Room 3 had been burnt although there was no evidence elsewhere to suggest destruction by fire.

To the south was a substantial gravel-and-mortar layer forming an alley or yard which continued for a few metres east of Building 67. In the machine-dug trench to the east, the layer directly overlay the

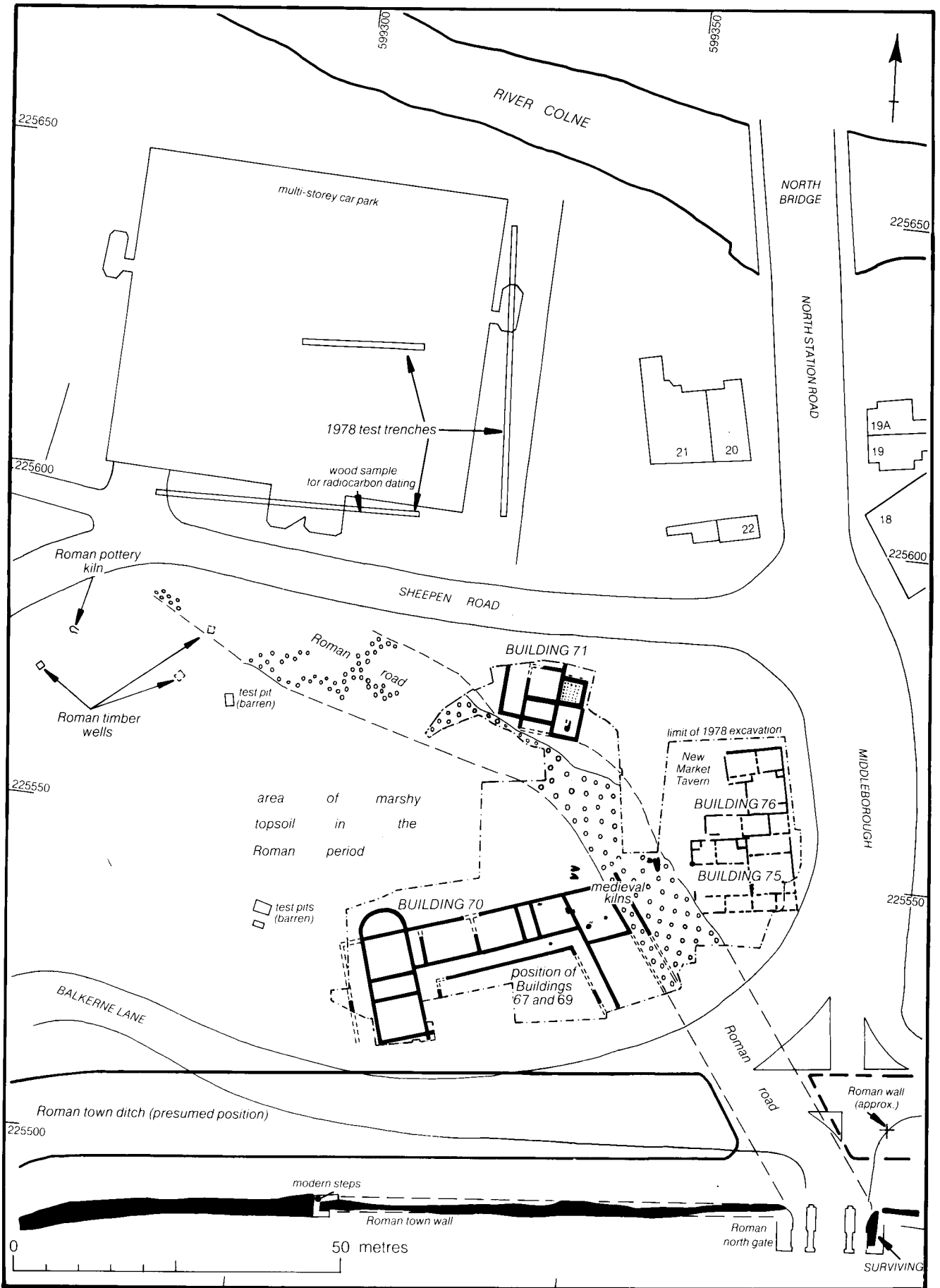


Fig 144 The Middleborough site in relation to the river Colne and the north-west corner of the colonia.  
 [Page 155]

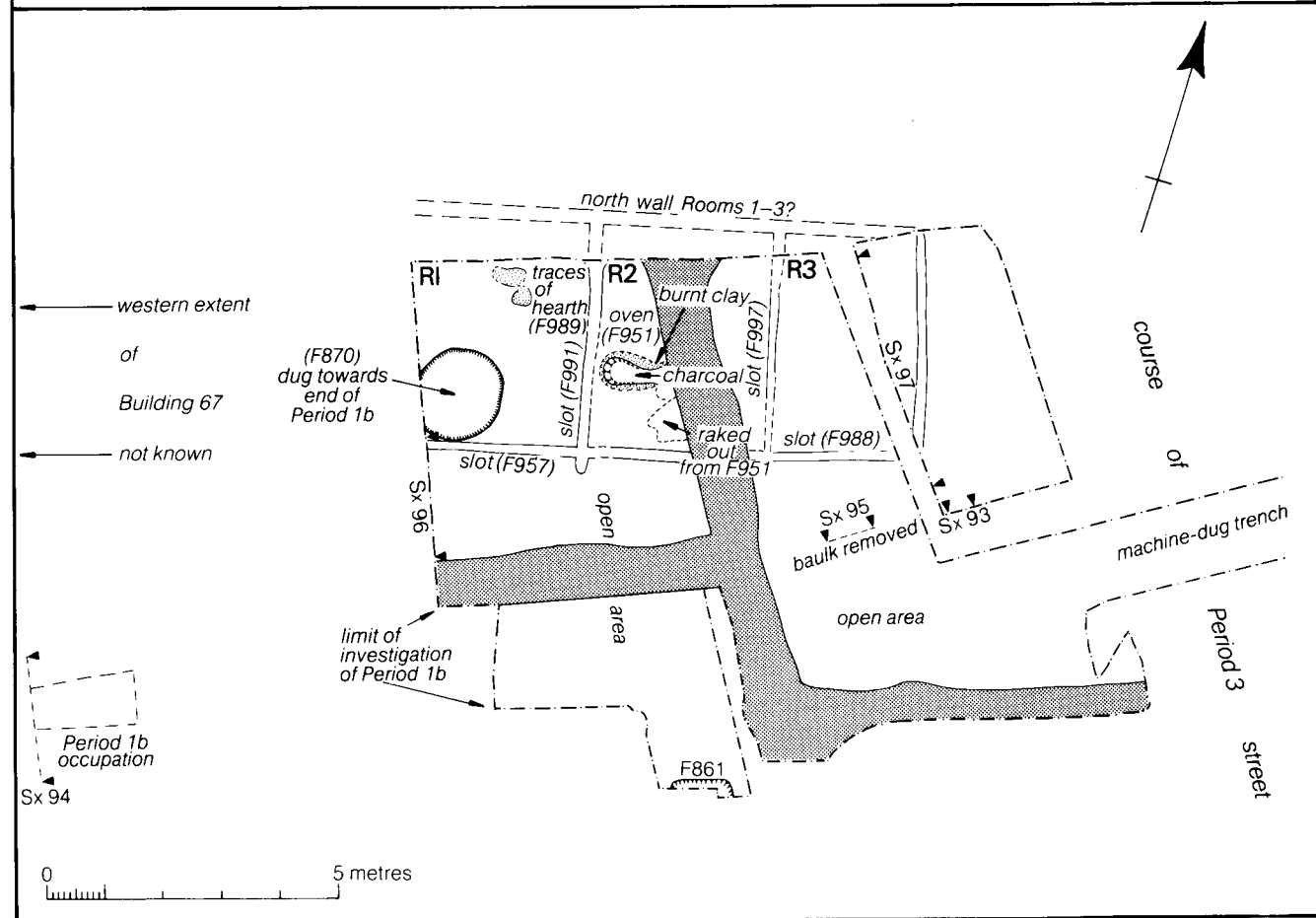
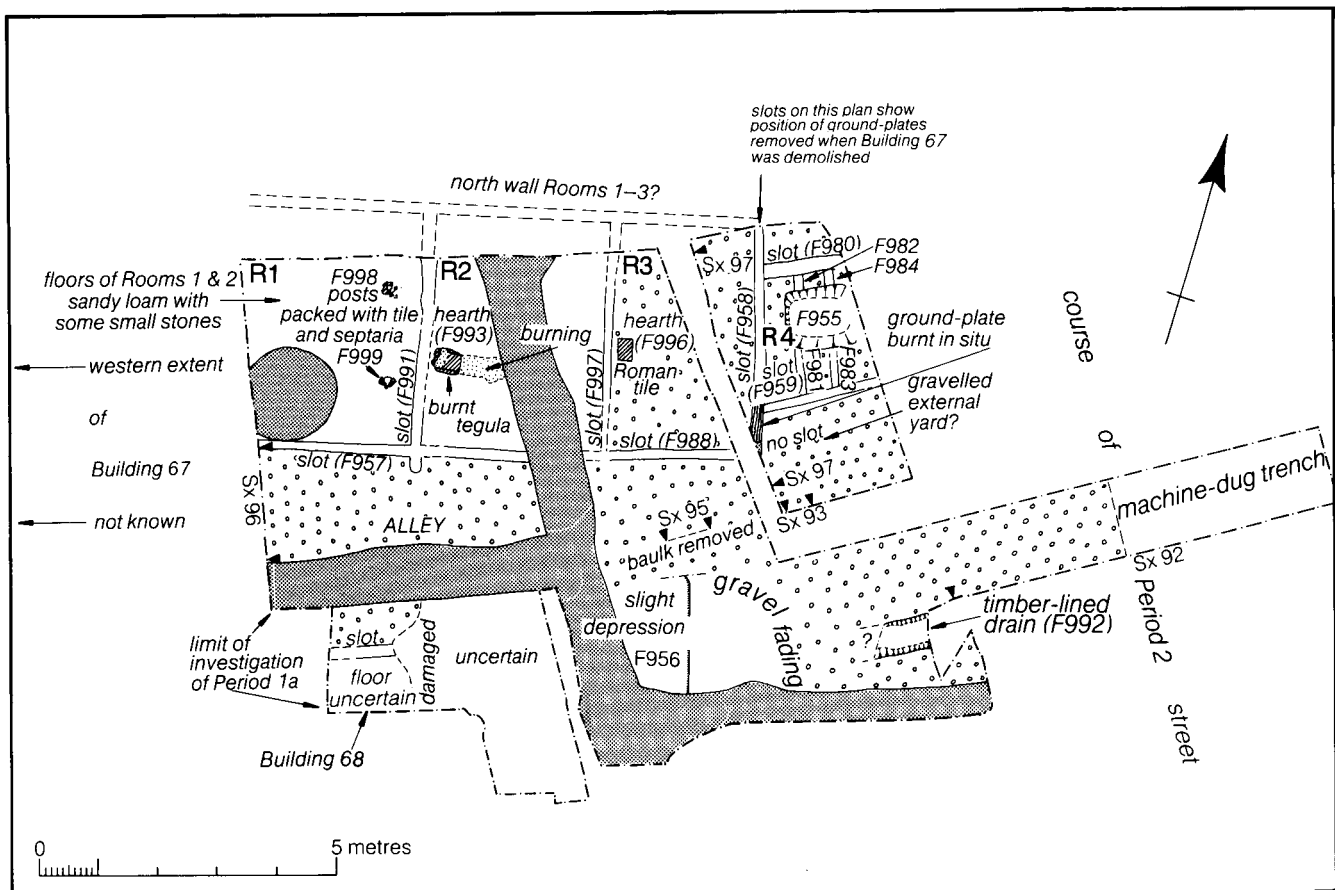


Fig 145 Building 67, Phases 1 (above) and 2 (below) and Building 68 (above). [Pages 155-8]

natural. To the north, the walls of Rooms 3 and 4 sealed this layer indicating that these rooms were later additions. No distinct Period 1 street was detected in the sections of the machine-dug trench (Sx 92, microfiche) although, at the very east end where the street ought to have been visible, the trench was not extended down to natural for reasons of safety.

South of the alley, a small part of Building 68 was uncovered (Fig 145). This consisted of part of a slot for a ground-plate and a small area of a daub floor. To the east, part of an underground timber-lined drain (F992) was uncovered. This was early and had been sealed by the gravel-and-mortar layer mentioned above.

**Phase 2 (Period 1b)**

In Period 1b, Building 67 was refloored. The floor level was raised by about 75 mm on the east side of the house and by about 110 mm on the west (Sx 97, microfiche). A new hearth (F989) was laid in Room 1

and an oven (F951; Fig 147, p 159) in Room 2. A large pit (F870) was dug against the south wall of Room 1. Daub from the demolished walls filled the pit and formed the floor of Period 2 showing that the pit had been open when Building 67 was demolished.

During Period 1b, the situation was unclear south of the slot (F957). No traces of structures were detected although daub floors were present with overlying occupation consistent with the inside of a building. Building 68 was demolished in Period 1a perhaps leaving the area open.

**Building 69 (Period 2)**

**Phase 1 (Period 2a)**

[Detail plan Fig 148, p 160]

Building 69 was of two phases (Periods 2a & 2b). Its walls were timber-framed, daubed, plastered, and painted. Its outer wall was built on a stout foundation

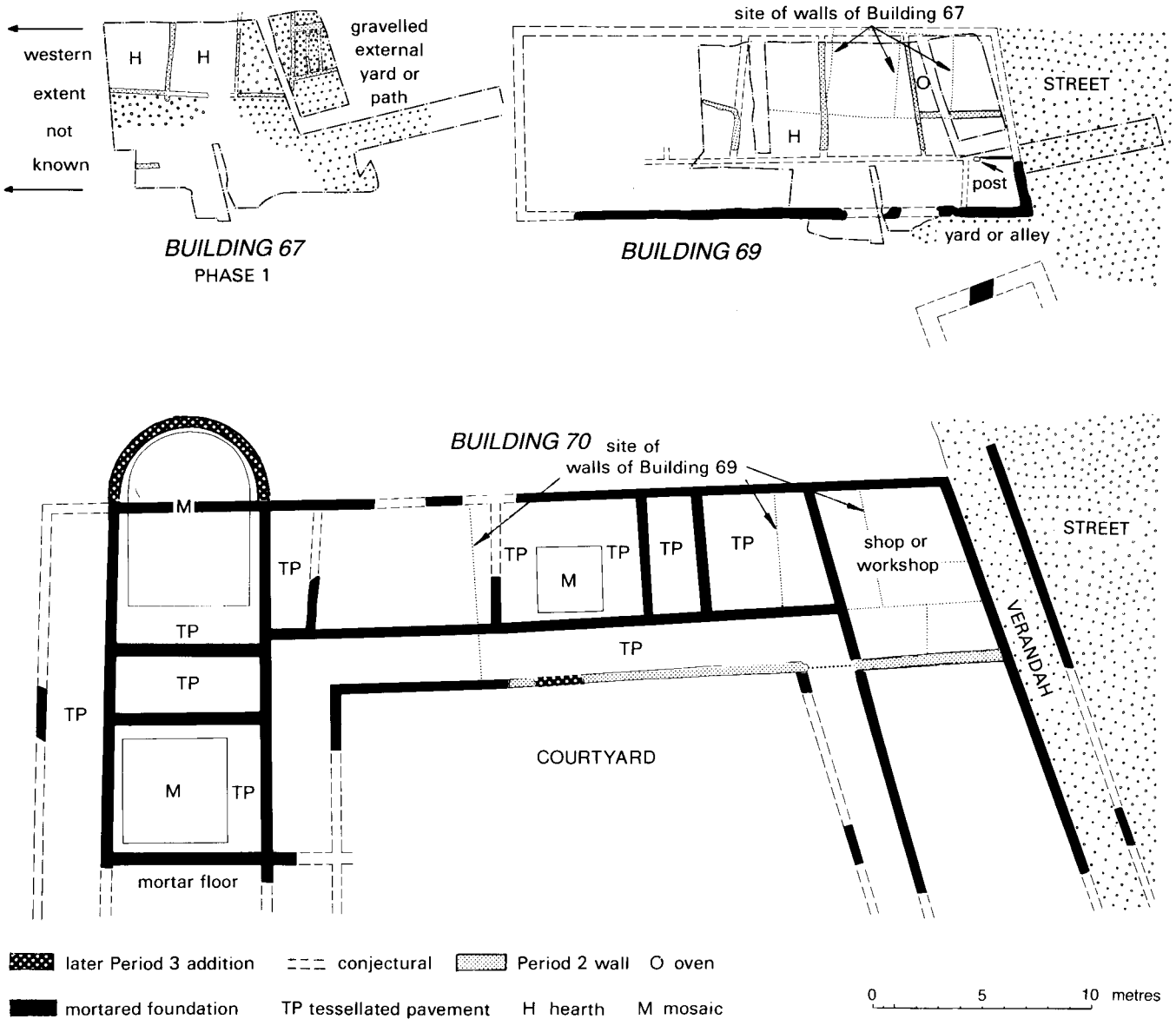


Fig 146 Relationship of Buildings 67, 69, and 70. [Pages 155-66]

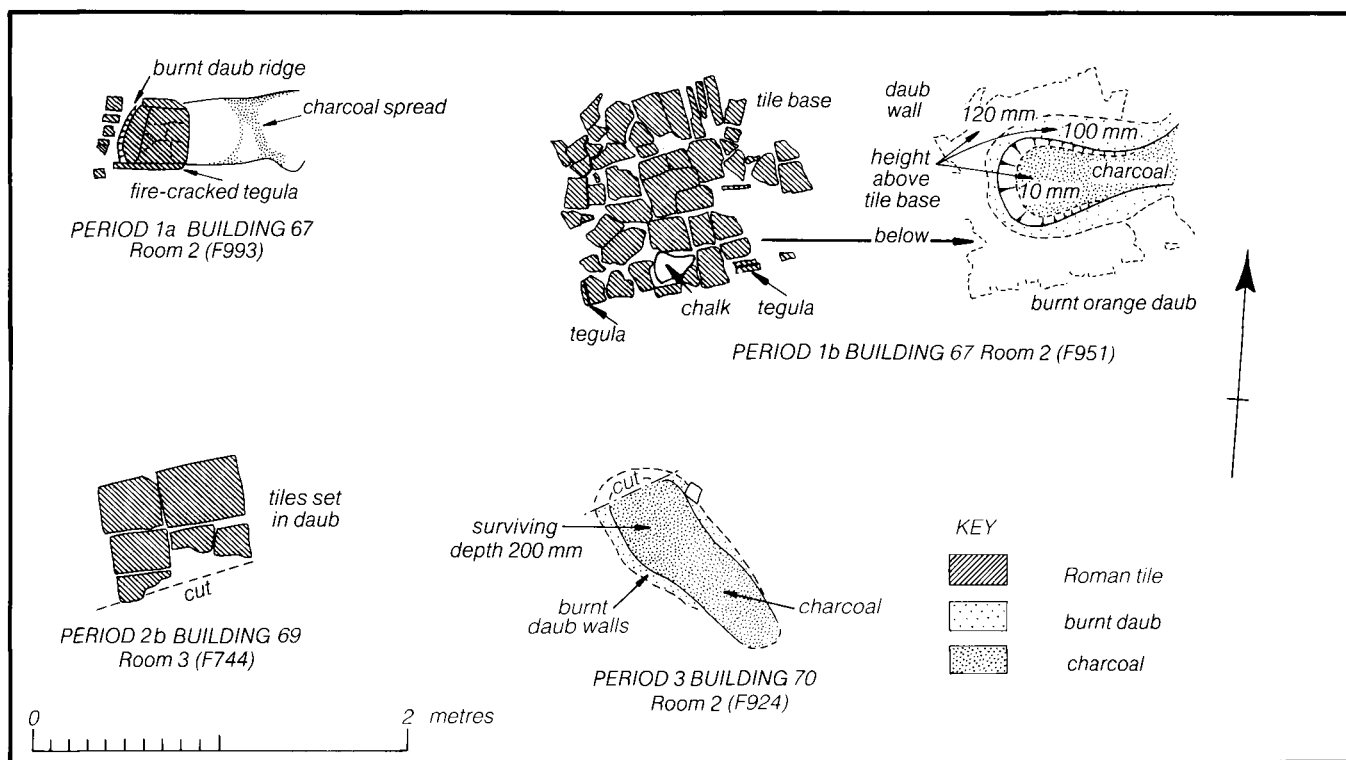


Fig 147 Hearths and ovens. [Pages 155-65]

of mortar and septaria. The floor of Room 3 had been patched several times and had traces of burning *in situ* which suggested the existence of a hearth against the south wall. The position of one of the upright studs (F987) in the south wall of Room 4 was found; in section it measured 60 x 100 mm.

In Room 1 were pieces of keyed daub equivalent in area to 0.08 square metres. Although badly damaged, the keying seemed to be formed of lozenges 40-50 mm in length similar to those on the base of a pre-Boudican wall at Lion Walk (Fig 13, p 24).

### Phase 2 (Period 2b)

[General plan Fig 146, p 158; detail plan Fig 149, p 161; wall plaster Fig 150, p 162, & Fig 169, p 181]

In Period 2b, partitions were inserted into Building 69 to divide Room 4 into three compartments (Rooms 4a, 4b & 4c) and to create a small room (5) at the east end of the passage (Fig 149). New floors were laid throughout, those in Rooms 3, 4a, and the passage (Room 5) being of mortar on a base of gravelly sand 75-100 mm thick (Sx 96, microfiche). Quarter-round mouldings at the foot of the walls occurred in Rooms 3 and 4a. These were of *opus signinum* and were 80 mm wide. Each had a flattened top.

The floors were sealed by a layer of daub and broken wall plaster left after the demolition of the building. Over the eastern half of the mortar floor in Room 4a, the plaster lay as a large mass of daub and plaster which seemed almost entirely to have belonged to the east wall of the room. It contained several large fragments of plaster which lay face downwards in positions which corresponded closely to their original locations on the wall (Fig 150). At the base of the wall

and on both sides of it, much of the plaster survived *in situ* and in places stood up to a height of 400 mm. From the relationship of the collapsed plaster to the mortar floor, it was apparent that a layer at least 300 mm thick of broken daub and wall plaster had lain on the floor before the timber-frame in the east wall was removed. This debris had helped hold the base of the plaster in place when the ground-plate was pulled up. The wall must have been constructed in Period 2b since the base of the plaster stopped at the top of the mortar floor without extending below it. The total wall area of Room 4a is likely to have been about 30 square metres (very approximately). Thus only about 15% survived *in situ* or in the demolition debris (Appendix 6). The wall plaster is discussed on pp 181-2.

To the south of Building 69 was the edge of a gravelled area which probably had been part of an alley on to the main street to the east. Further south, a substantial foundation (F862; Fig 149) was encountered in a trial trench. The plan of the building to which this belonged and its relationship to Building 69 are not known.

### Building 70 (Period 3)

[General plans Fig 146, p 158, & Fig 153, p 164; detail plan Fig 151, Sheet 5b; photographs Fig 152, p 163 & Fig 154, p 165; mosaics Figs 155-62, pp 165-74]

Although Building 69 was demolished, its replacement (Building 70) incorporated part of its southern wall (Fig 146). The new building was substantial and broadly of two phases (Periods 3a-b; Figs 151-3). It consisted of rooms ranged round at least three sides of a central courtyard. The nature of its



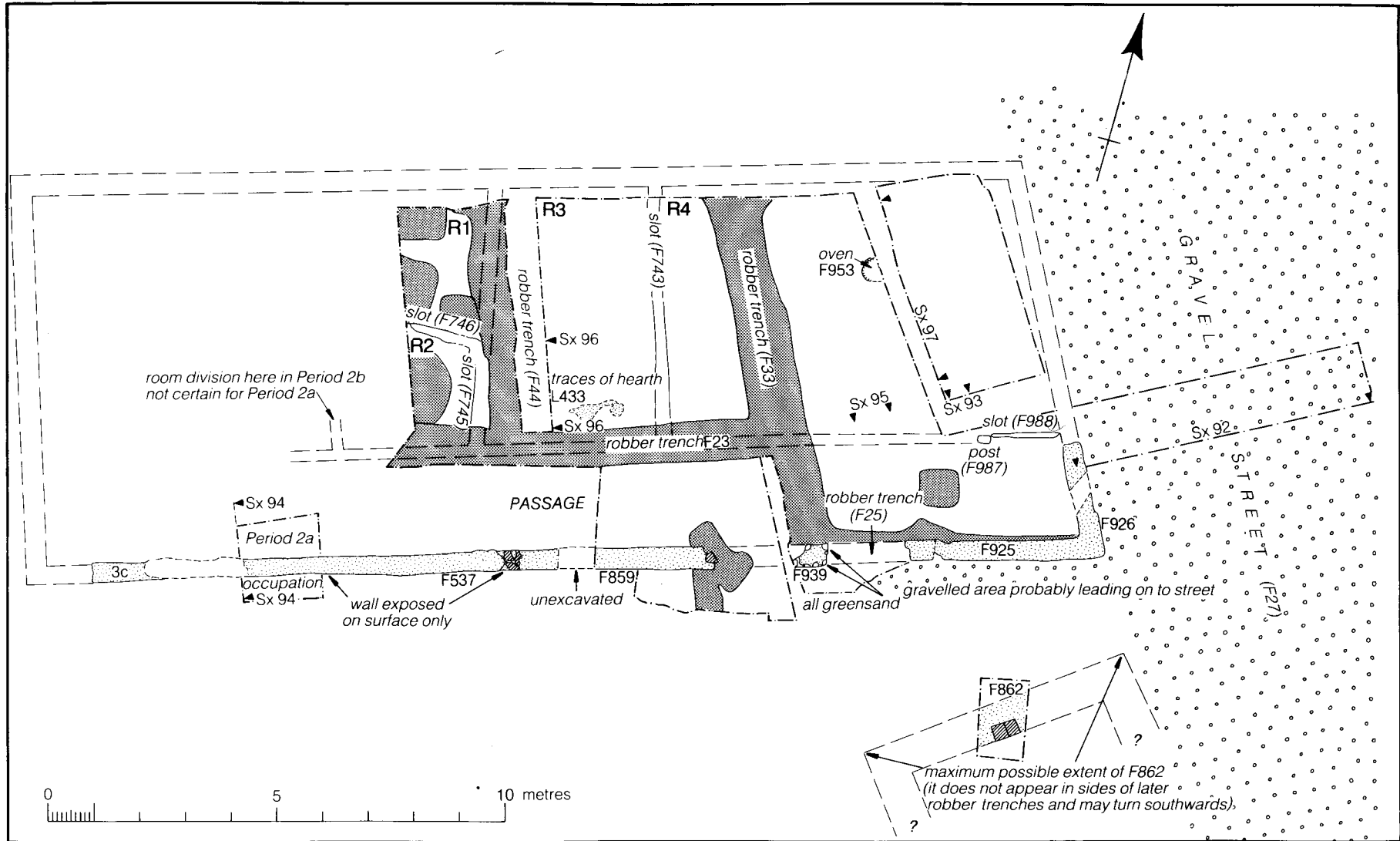


Fig 148 Building 69, Phase 1. [Pages 158-9]

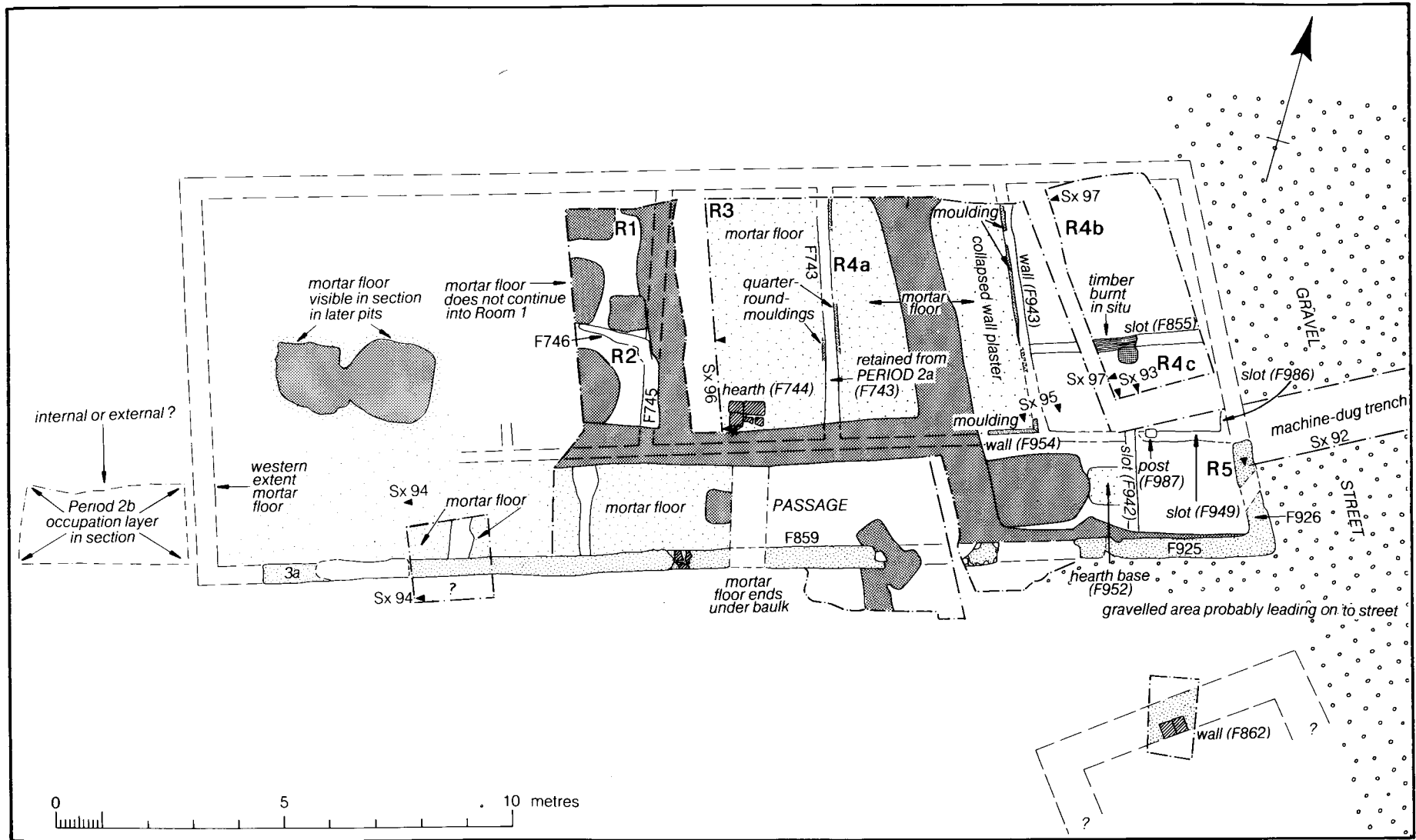


Fig 149 Building 69, Phase 2. [Page 159]

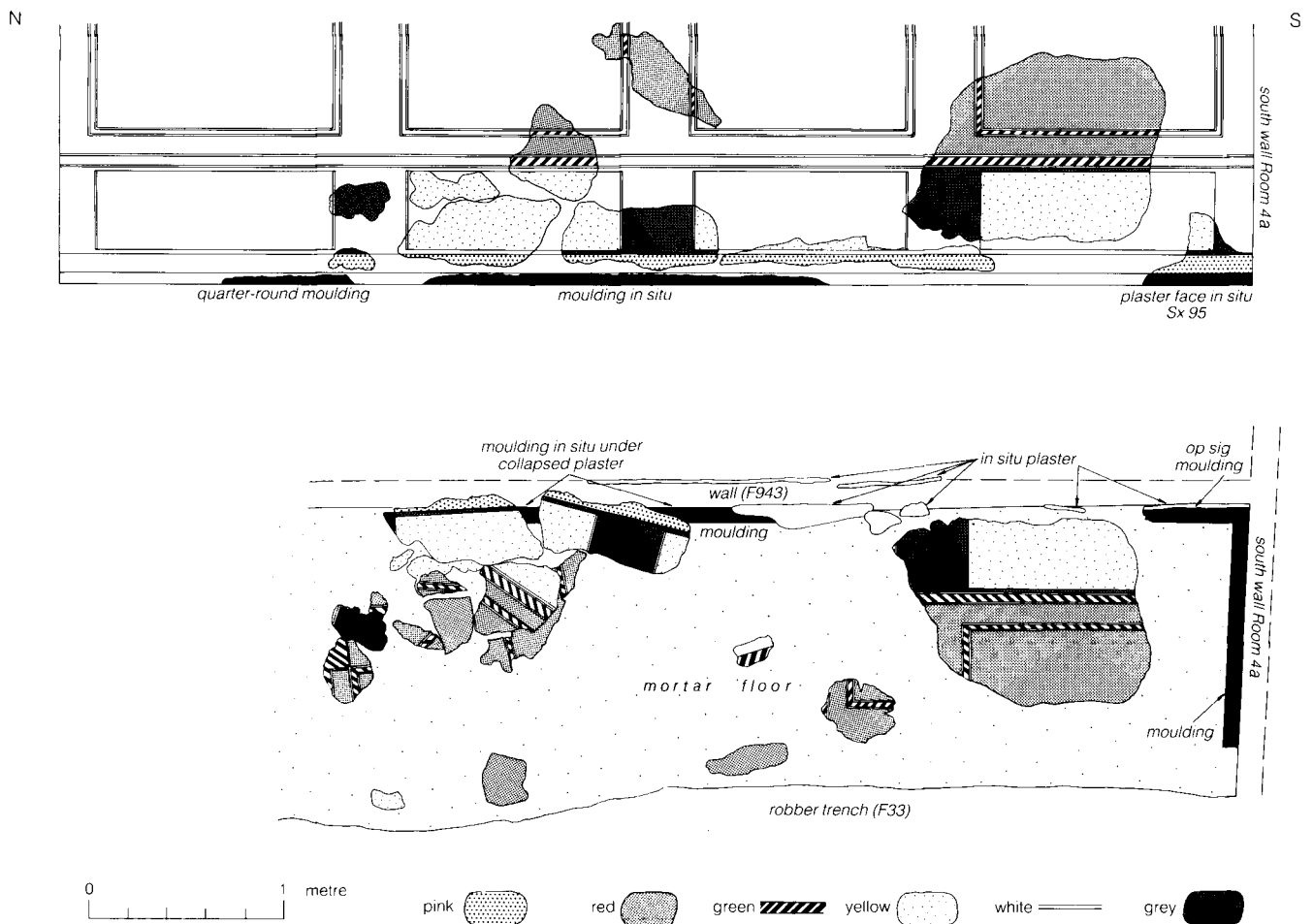


Fig 150 The wall plaster from east wall of Room 4a in Building 69, Phase 2 (above: reconstruction; below: position of fragments in demolition debris). [Pages 159, 181-2]

south side is unknown since the remains of this lie under the modern Balkerne Lane (Fig 144, p 156) and therefore were not available for examination. The two rooms which faced the street had plain daub floors and were thus presumably for commercial or utilitarian use in contrast to the two large rooms at the west end which had been the principal rooms of the house. At first, in Period 3a, the building (or at least as much as was available of it for excavation) had only one mosaic floor (in Room 4) but in Period 3b mosaics were laid in Rooms 6 and 7 contemporary with the addition of an apse to Room 6. The foundations of Building 70 were sturdily constructed (Fig 151; Sx 98, Sheet 6b) in roughly coursed septaria set in hard, light brown mortar. The foundations which survived had flat, mortared tops at contemporary ground level indicating that the superstructure had probably been timbered. The impression of wood grain was visible on top of the foundation of the west wall of Room 1. This impression, 400 mm wide, showed that a timber had been laid on the foundation before the mortar of the latter had dried out (as at Building 59). The debris over the floors of Building 70 derived from its demolition and consisted of brownish yellow sandy clay with fragments of wall plaster. This indicated that the

superstructure had been of daub and, in at least some of the rooms, plastered and painted.

The south wall of Passage 2 was of a more complex construction than the other walls which survived. It was stone and mortar and incorporated part of the earlier Period 2 wall and foundation (Fig 146). The eastern 4.8m of the new wall was the Period 2 structure reused with its wall plaster left in place. The remaining 8.8m of the wall was built on top of the Period 2 foundation (Fig 151; Sx 94, microfiche). It is possible that the east wall of Room 2 and the north wall of the building as far over as the west side of Room 4 incorporated parts of Period 2 walls but this could not be determined because the relevant foundations had been robbed. However, in these places, the positions of Period 3 walls coincided with those of Period 2 and the robber trenches were deeper than elsewhere thus suggesting the previous existence here of Period 2 foundations.

The foundations of the external walls of Building 70 were more substantial than those inside and that of the eastern wall of the verandah (Passage 1) along the street frontage. The difference must reflect those walls which were intended to be load-bearing and those which were not. Part of a pilaster lay among the

demolition debris in Passage 2, directly south of Passage 3. The pilaster had been on the south face of the north wall of Passage 2. Although partly disintegrated, it had been 0.4m wide and at least 1.10m high. Of the areas of the pilaster intended to be seen, all three sides had been plastered and both corners were bevelled within the thickness of the plaster. In addition to the pilaster, two fragments of column were in the demolition debris in Room 7 (Appendix 3, microfiche). One piece was part of a plastered column of mortar and tile and the other was a simple stone capital or base. The latter must have butted against a wall since only three of its faces were properly finished. All three faces had traces of red paint.

When Building 69 had been demolished, the level on the east side of the site of Building 70 was higher than the western side which had hitherto been an open space occupied by damp, rather badly-drained topsoil. The eastern side was approximately 6.4m above Ordnance Survey datum whereas on the west it was 5.6m at the south side sloping to 4.6m at the north. To enable the floors to be on the same level throughout Building 70, the ground level was raised with large quantities of dumped material especially in the area later occupied by the west range (Sx 98, Sheet 6b). The make-up consisted of sandy gravels and loamy clay laid down in roughly horizontal layers. In places the natural had distinct steps showing that some of the topsoil had been removed prior to



Fig 152 Building 70, viewed from the west. [Pages 159-66]

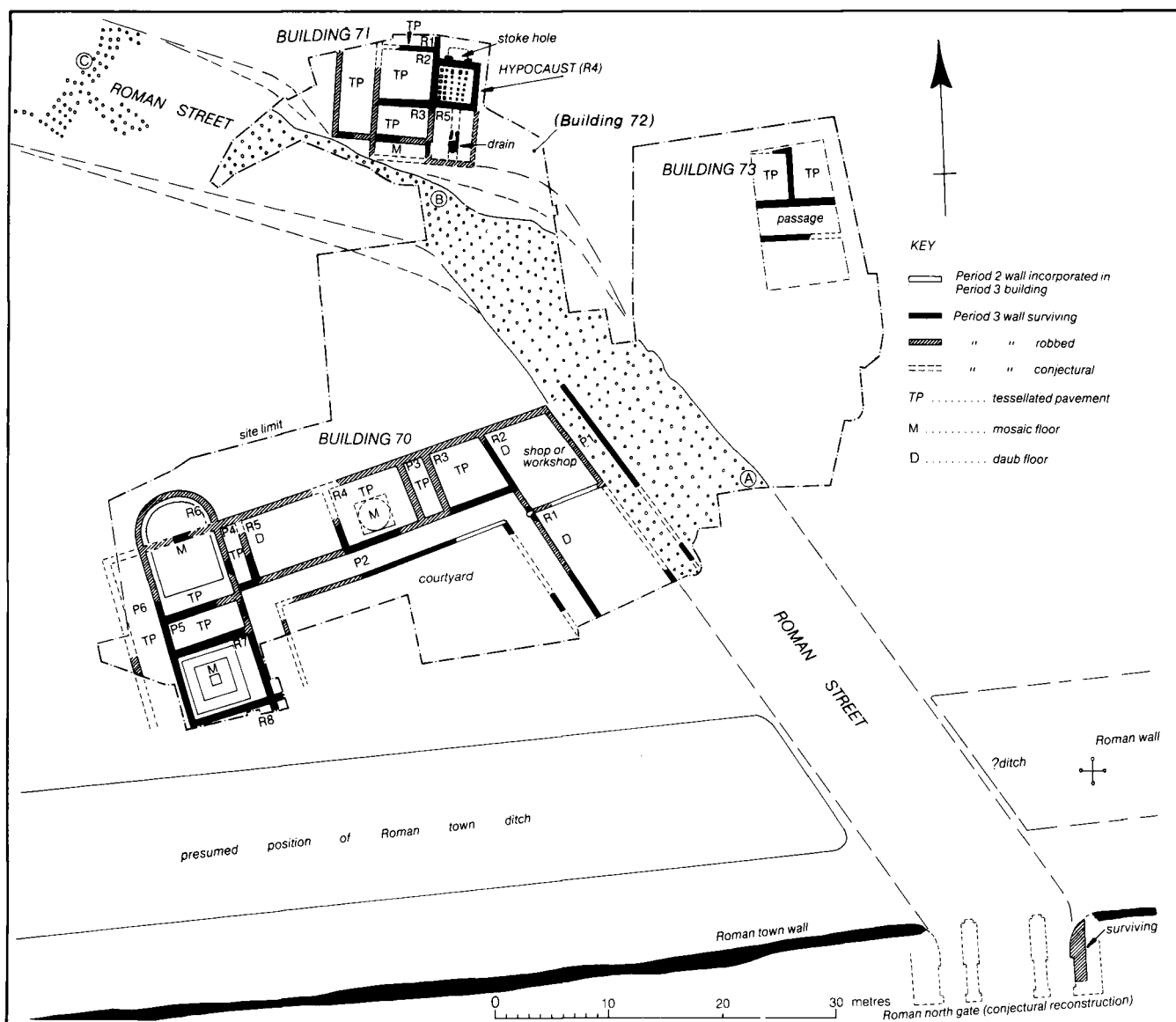


Fig 153 Middleborough Period 3, Buildings 70-3 (c 150-300). [Pages 159-80]

dumping presumably because it was considered unsuitable for building.

Spits of mortar projected into the surrounding dump layers from the sides of the foundations showing that the foundations were raised in conjunction with the dumping of the make-up. Two layers of charcoal-rich soil in the dump (Sx 98, Sheet 6b) suggest that the dump and the foundations were of three phases. The lower layer of charcoal-rich soil extended for the combined lengths of Room 6 and Passage 5 and presumably derived either from a bonfire or a hearth or an oven associated with the building operations.

Despite the considerable efforts which were made to level the site, when finished Building 70 still sloped slightly to the north and west. The eastern wall of Passage 1 (F3) sloped down from south to north and the floors of the rooms dropped in level from east to west by stages. After allowing for the effects of settlement where this occurred, the floor levels were as follows: Room 3 at 6.3 m, Room 4 at 6.25 m, Room 7 at 6.10 m and Room 6 at 6.05 m. The floor of Room 4

was 0.25 m above the floor in Passage 2 implying a small step between the two.

The dumping of make-up only took place in the area of Building 70 so that marked differences existed between the level of Building 70 and elsewhere. For example, the floors of Building 71 were approximately 0.7 m below those of Building 70 and the gravel street dropped 1.9 m in height between points A and C on Figure 153.

The make-up under Building 70 was not wholly effective since considerable settlement of the floors took place. This was at its greatest in the centres of the rooms since around the sides the floors received some support from the foundations which, being deep and built on more stable subsoil, were unaffected by settlement.

Room 1 was not excavated but from the sides of the later robber trenches, it was clear that it had at least one floor and that this was of daub. Room 2 was similar but was fully excavated and four phases were

detected. All its floors were of daub. In Phase 1, the room contained an oven (F924; Fig 147, p159). In Phase 2, some postholes and shallow pits were dug against the east wall of the room and a rectangular pit (F724, Fig 151, inset) was placed in the north-east corner of the room. This was probably the remains of an unusual type of oven. There were two postholes on the south edge of the pit and one in the centre of its eastern end. The bottom of the pit had been intensely burnt and in the western half there was a layer of sandy loam containing small fragments of shapeless burnt daub presumably from the superstructure over the pit. In Phase 3, the oven was demolished and in its place were built a rectangular tile hearth (F513/4) and four other groups of tiles laid flat (F515a & b, F518, & F516), two of the groups being associated with white mortar and *opus signinum*. Although now fragmentary, the four groups of tiles had probably been hearths. It was not clear if any of these had been in use at the same time. In its fourth phase, a new floor was laid and a roughly square foundation built in the centre of the room. Its purpose is unknown. The foundation (F26) was robbed in early medieval times.

Room 3 was tessellated and irregular in plan. The latter reflects the angle between the street and the town defences to the south with which Building 70 was primarily but not accurately aligned. Room 4 had a small mosaic pavement with plain red tessellated borders (*see report below*). Most of it had been destroyed. Little survived of Room 5 because of extensive post-Roman pits but there was sufficient to indicate that its floor had been of daub.

Rooms 6 and 7 were of two phases. At first Room 6 was nearly square in plan and probably had a plain mortar floor. In Phase 2, the north wall of the room was demolished and replaced with an apse. A large mosaic (*see report below*) with red tessellated borders was then laid. The original mortar floor seems to have been completely broken up and used as make-up for the new mosaic (Sx 98, Sheet 6b). Apart from a few rows of the tessellated border on the south side of the room, all the tesserae had been scraped off the mortar base when the building was demolished. This is made clear by the fact that the base and the surviving rows of tesserae were directly sealed by a thick layer of daub left after the demolition of the walls.

Similarly Room 7 originally had a plain mortar floor. This had been set on a thick layer of septaria and mortar and had a quarter-round moulding on all four sides. In Phase 2, the base for the mosaic was laid directly on top of the floor and consisted of a layer of *opus signinum* about 100 mm thick. To form a key for the pavement, the original floor was pounded with a heavy instrument to form depressions averaging 40 mm wide and 10 mm deep (Fig 154). There were approximately 120 of these to the square metre of floor. In addition, the quarter-round moulding was smashed and mostly removed. Its replacement on the new floor survived intact on the north and east sides of the room. The mosaic was figured and of exceptionally high quality (*see report below*). Later, holes which developed in the pavement were patched

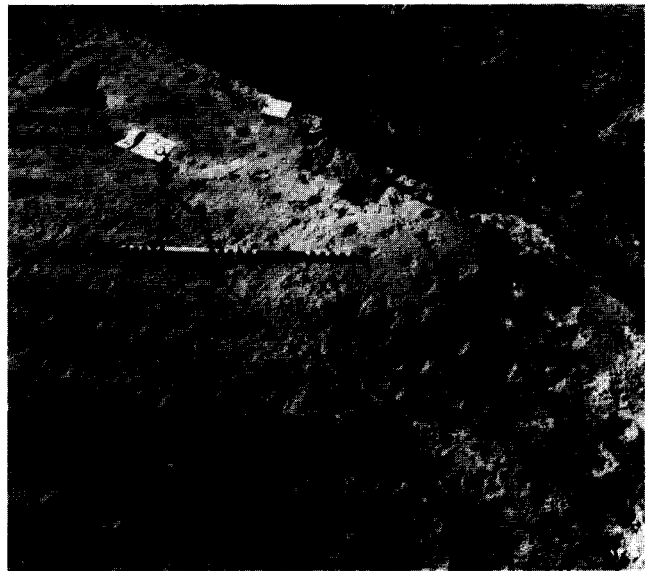


Fig 154 The depressions in the floor under 'The Mosaic of the Wrestling Cupids'. [Page 165]

with unsightly pink mortar and both ends of the south wall were rebuilt, the reason for which is unclear. A circular object, 0.85 m in diameter was fitted to the floor and held in place by three iron pins or dowels placed equidistant around the circumference (Fig 155). The underlying tesserae were removed before the object was set in position. The pins were too poorly preserved to determine the precise method of fastening. Possibly the object was a stone altar placed to touch the centre of the north edge of the square central panel of the mosaic. The object must have been set up some time after the mosaic was laid; its relationship to the mortar repairs is obscure. Being a secondary insertion into the building, the mosaic is difficult to date closely. The mortar repairs indicate that it was probably laid some considerable time

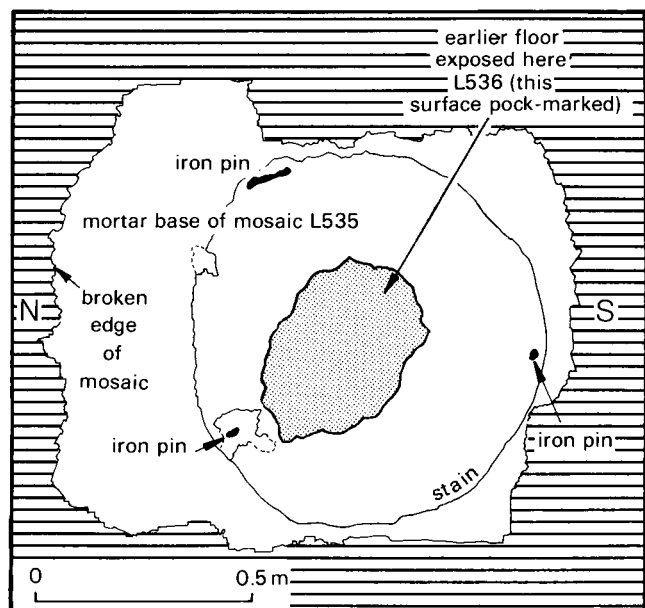


Fig 155 Detail of evidence for base set into 'The Mosaic of the Wrestling Cupids'. [Page 165]

before the demolition of the house and hence point to an approximate date for its construction within the range 150-250. This is in keeping with the assessment of date made on stylistic grounds by Dr D Smith (*see below*).

Room 8 was only partly uncovered, but it had a mortar floor similar to that in Room 7 and a quarter-round moulding survived on its north side. From what remained of its north wall, there does not appear to have been a doorway between Rooms 7 and 8.

Passage 1 was a verandah or portico along the street frontage. Like the street, its floor was compact gravel. The foundation of the east wall (F3) was of mortar and septaria and was not robbed (Sx 92, microfiche). Passage 2 had a mortar floor which contained large fragments of septaria and had a rather eroded, rough surface. Under the floor were two north-south slots (F856 and F860) of uncertain purpose. Later a 1.04 m stretch of the south wall of Passage 2 (F537) was repaired with tiles bonded together with daub (Fig 151). Passages 3, 4, and 5 were cross-passages with tessellated floors. The last of these, Passage 5, was of two phases which corresponded to those of Room 6. The first was a mortar floor which, as in Room 6, was apparently broken up to form the base for the tessellated pavement of the second phase. At the west end of Passage 5 were two opposing doorways. These were no more than 1.6 m wide and provided access into Rooms 6 and 7. The position of the doorway into Room 7 was indicated by the west end of the quarter-round moulding along the north side of the room. The end was rounded off. The locations of the jambs of the other doorway were less clear but the existence of a doorway was shown by the tessellated pavement in Room 6 which overlapped by a few rows the foundation between the room and the passage. A small lip existed between the top surface of the foundation and the southern row of tesserae implying that there must have been a thin stone or wooden threshold over the foundation since otherwise the cubes could have been quickly kicked out of place. Later the north face of the south wall of Passage 5 was extended northwards with tiles set in mortar (Sx 98, Sheet 6b). This sealed the most southerly rows of tesserae of the floor of the passage. The surface of the new wall was plastered and painted red. Later it was repainted mustard yellow. The alteration to the wall may have been a response to the effects of settlement which caused large cracks to appear along the bases of most of the walls (Sx 98).

Although nothing survived of the west wall of Passage 6 it must have been of a light construction because the bottom of the robber trench dug to remove it was only about 0.45 m below the adjacent tessellated pavement. The latter sealed at least 0.2 m of collapsed white painted wall plaster implying that the pavement was secondary. If, as seems likely, the passage itself was part of the original design of the house then its first floor must have been of daub. Like Rooms 6 and 7, the earliest levels could only be examined superficially.

Two layers of pale brown mortar (Fig 151; L565 & L566) were discovered adjacent to wall F1012, south-

east of Room 8. These were not floors but were presumably odd patches of mortar formed during the construction of the house.

During the demolition of Building 70 in *c* 300, the possible altar in Room 7 was removed and the cubes forming the mosaic in Room 6 were scraped off their mortar base. The mosaic in Room 7 was not destroyed presumably because its mortar base was exceptionally hard and the cubes were consequently too firmly fixed to be dislodged easily (a fact made very evident in 1978 when the pavement was being lifted). A layer of daub and broken wall plaster lay over all the latest floors and derived from the demolition of the walls. This was at its thickest at the west end of the house especially in Room 7 where, because of subsidence, the layer survived to a depth of 0.45 m. The absence of roof tiles in any quantity in the demolition debris is consistent with the stripping of the mosaic in Room 6 and indicates that, where practicable, salvable materials were removed as the demolition work progressed. The tesserae were presumably sold to a firm of mosaicists for reuse elsewhere.

#### **The mosaic in Room 4**

*by David S Neal*

[Plan Fig 156, p167; reconstruction Fig 157, p167]

Room 4, the axial room in the building, measured approximately 5.1 m (north-south) x 6.0 m (16 ft 9 in x 19 ft 8 in). Fragments of a mosaic and its plain surround survived on the south and west sides (Fig 156). These sufficed to show that the mosaic had been a panel about 2.68 m (8 ft 9 in) square, laid off-centre, with a polychrome design executed in tesserae approximately 9 mm (0.4 in) square. The pavement had a plain surround approximately 0.14 m (6 in) wide executed in grey tesserae averaging 20 mm (0.8 in) square.

In the square of mosaic was a circle of simple guilloche 2.63 m (8 ft 8 in) in diameter. Parts of two of the resulting spandrels remained in the south-east and south-west angles. Each was occupied by a cantharus within a linear frame shaped to fit the spandrel. The canthari were of different forms but both were depicted as slightly below eye-level and were shaded internally. Neither is of the well designed, wide-mouthed form which appears in other mosaics of Colchester, one of which has been tentatively dated to the mid 2nd century (Smith 1967, 41, adding *id* 1975, 273, n 23, pl 106 = Neal 1981, no 39; cf Hull 1958, pl 33). Two tendrils rose from behind each vessel and turned in opposite directions, those in the south-east spandrel ending in leaves and those in the other parting to enfold a pseudo-floral terminal.

The above description is based on the careful, detailed painting by Mr RHMoyes, a photograph of which was submitted to the present writer in the hope that he might be able to suggest a reconstruction of the design within the circle of guilloche. The painting shows that the fragments preserved the beginning of a band of simple guilloche projecting into the circle at an angle opposite the south-east spandrel and, on the

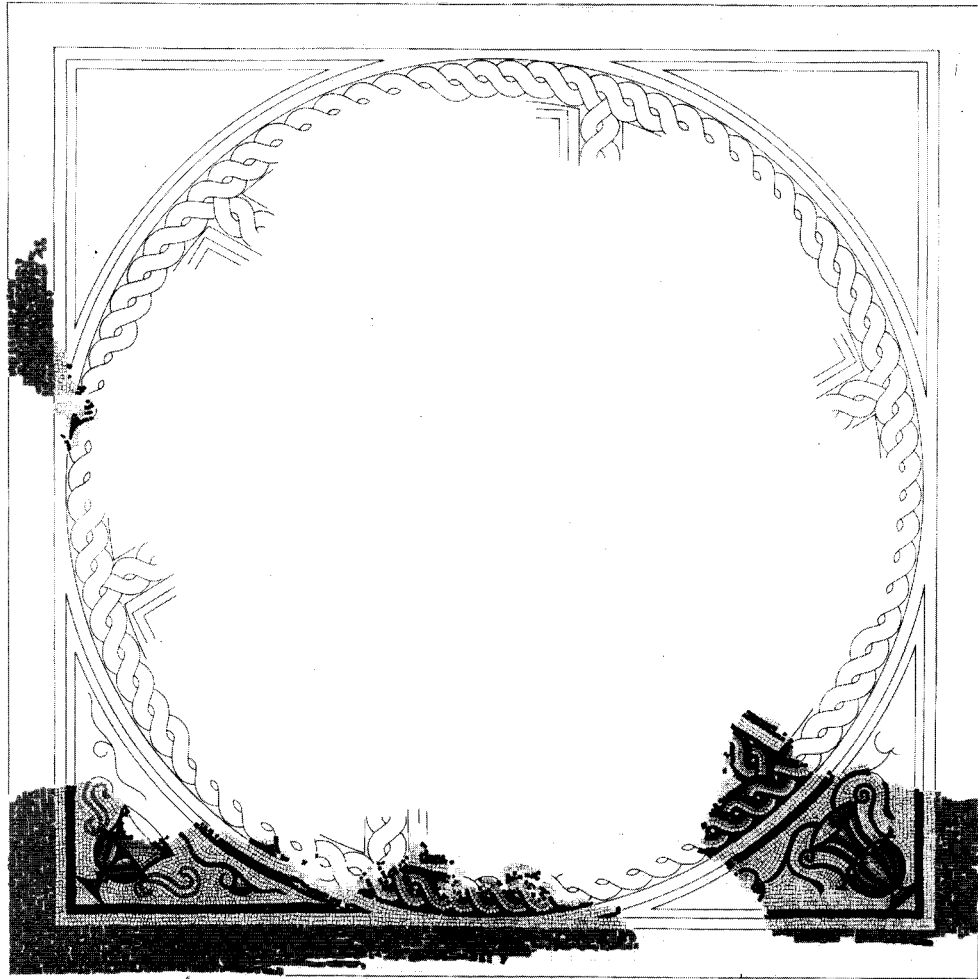


Fig 156 Painting (by R H Moyes) of the mosaic in Room 4 of Building 70. [Pages 166-8]

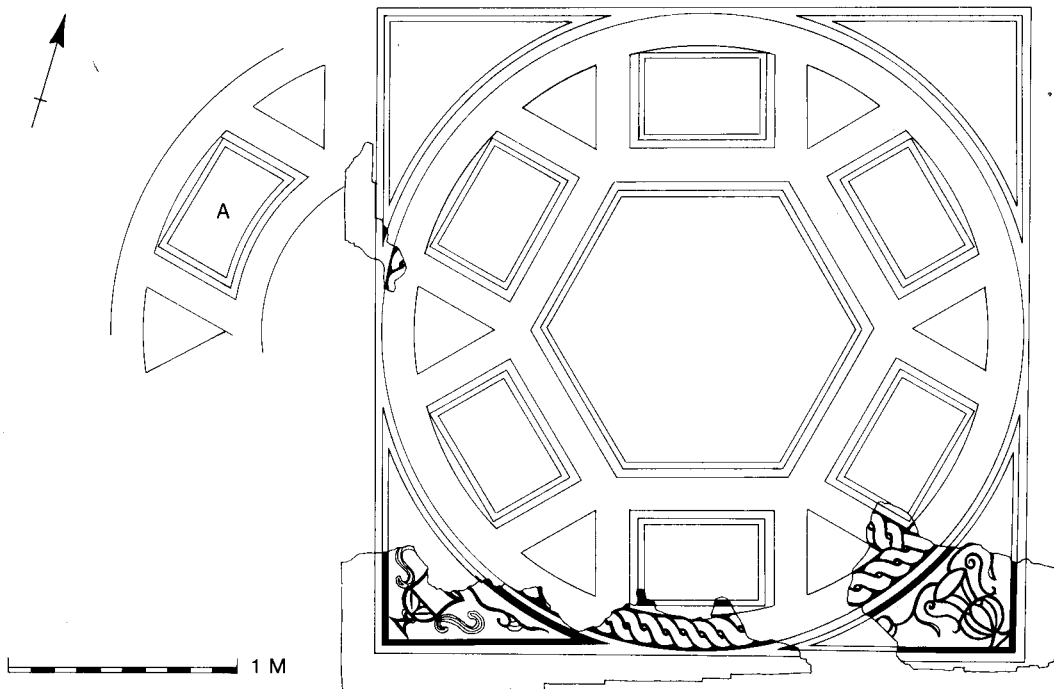


Fig 157 Reconstruction of mosaic in Room 4. (Drawing by D S Neal, Crown copyright reserved). [Pages 166-8]



north-east side of it, part of the linear frame of a panel. Near the south-west spandrel there remained part of the angle of a similar frame, the west side of which was apparently at the same angle to the circle as that of the other. The angles of these frames touched the circle. Evidently, therefore, the circle had been divided into panels with linear frames by bands of guilloche running inwards from it. It is evident, however, that the inward-projecting bands of guilloche did not converge towards the centre of the circle and the only possible reconstruction of the design (Fig 157) shows that they must have formed rectangles about 550 mm (22 in) wide and triangles alternating around a hexagonal central panel (or, but less probably, circular; see Fig 157, A).

This design is most unusual in Britain. Only two other mosaics have comparable designs, though neither affords a close parallel. One is that of Room 3 at Bignor (Sussex; Lysons 1817, pl 18). There the design is contained in an octagon inscribed in a square, with a central octagonal panel, and the height of the surrounding panels considerably exceeds their width. The other pavement is that of Room W at Keynsham (Somerset; Bulleid and Horne 1926, fig 6). There the design was hexagonal, with a hexagonal central panel, and the rectangular panels corresponding to those at Bignor were approximately square (Neal 1981, fig 10, K). The designs at Bignor and Keynsham are, however, much more elaborate than is suggested by the foregoing summary descriptions, and also much more elaborate than that of Middleborough. Both were figured, and it is most unfortunate that at Middleborough nothing survived even to suggest what the panels depicted. Furthermore, both can confidently be assigned to the 4th century, but the much simpler design and character of the Middleborough mosaic probably indicate an earlier period. The pavement could be as early as *c* 150, the *terminus post quem* of the construction of Building 70, and is almost certainly not later than the mosaic of Room 7 in the same house which has been assigned to *c* 150-175 (see below). ■

### The mosaic in Room 6

[Tentative plan Fig 151, Sheet 5b]

Although all the cubes of this pavement had been removed in *c* 300 when Building 70 was demolished, a careful examination of the mortar bed for the tesserae revealed a series of lines and curves caused by rows of depressions made by the bottoms of tesserae. Depressions could only be detected for the largest cubes since, being deeper, these had been pushed slightly further into the wet mortar when the pavement was being laid. Most of the rows were extremely faint, the clearest being made by the large cubes which formed the plain red tessellated borders. Various methods were tried to make the faint rows more distinct. The most successful of these involved the gentle use of an electric sander. This had the effect of making the highest spots clean and light in colour so that they were in contrast with the depressions which were unaffected. Moreover, it was

found that the best time to examine the mortar base was when the sun was shining and low in the sky.

However, despite these various efforts, the work proved disappointing because a meaningful plan of the mosaic could not be recovered. The plan which was made of the rows of depressions (Fig 151) shows them graded in terms of two categories, the clearest being indicated by unbroken lines. The pattern which emerged seems to suggest that the design had been mainly in straight lines with two (and hence presumably in reality four) circles incorporated in it. However, even if the most difficult lines are omitted, it is still hard to see in the remaining lines a symmetrical pattern which can satisfactorily be reconciled with a known mosaic design.

### 'The Mosaic of the Wrestling Cupids' in Room 7 by D J Smith<sup>1</sup>

[Plan Fig 158, p 169; details Fig 159, p 170]

Room 7, in the west wing of the building, measured 5.8 x 6.7 m (19 ft x 22 ft).<sup>2</sup> The mosaic, surrounded by a plain border of grey tesserae approximately 38 mm (1.5 in) square, measured 4.85 x 5.20 m (15 ft 11 in x 17 ft 1 in) and had been executed in much smaller tesserae ranging up to 10 mm (0.4 in) square (Fig 158). It had been laid off-centre, the outer edges of the surrounding grey border being 1.5 m (4 ft 9 in) from the east wall and 0.5 m (1 ft 8 in) from the north and south walls. A substantial quarter-round skirting of *opus signinum* surrounded the room, over-riding the plain red border, and the pavement was also bedded on *opus signinum*.

The dimensions of the mosaic include a dark grey band 235 mm (9 in) wide and separated from the west side of the actual design by a band of the white background 115 mm (5 in) wide. The design itself therefore is 4.85 m (15 ft 11 in) square. For convenience, however, it can be described as consisting of two concentric squares, with the central third of each side of the outer square incurved as a semi-circle tangent to the inner square, resulting in four swallow-tailed interspaces, and the outer square surrounded by borders. Both squares are formed of round-tongued double guilloche 210 mm (8 in) wide.

In the inner square is a figured panel, actually 940 x 965 mm (37 x 38 in), with a frame of two rows of dark grey tesserae, which was orientated to be viewed from the west. This preserves the greater part of the notably well modelled legs of two evidently boyish figures, both nude, who appear to be wrestling (Fig 159). There also survives part of a wing of the figure on the spectator's left. Under the feet of both figures is a broad and slightly undulating band which extended across the panel and represented their shadows. Above, on the spectator's right, a bird steps towards the figures on a thinner band of shadow. The tesserae in this pseudo-*emblema* are smaller than in the rest of the mosaic, many being only 6.4 mm (0.25 in) square or even less. Many others are oblong.



Fig 158 Painting of 'The Mosaic of the Wrestling Cupids' (R H Moyes). [Pages 168-74]

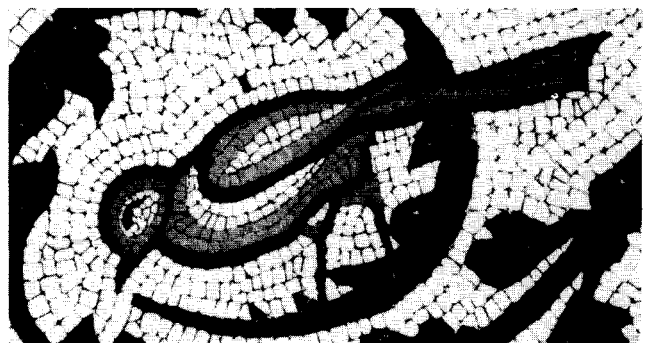
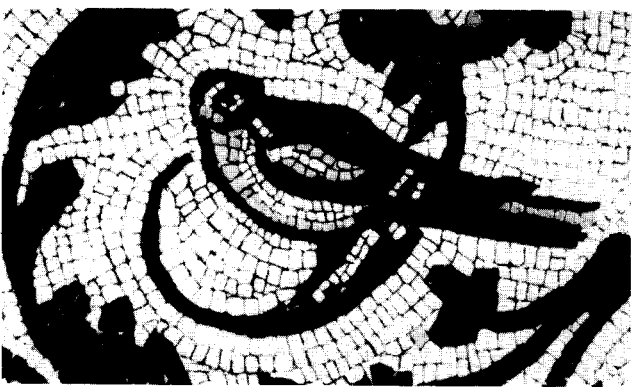
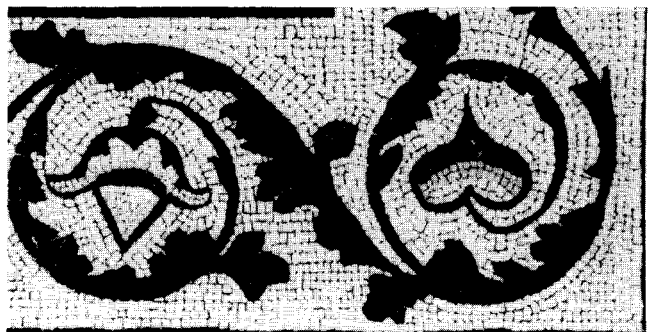
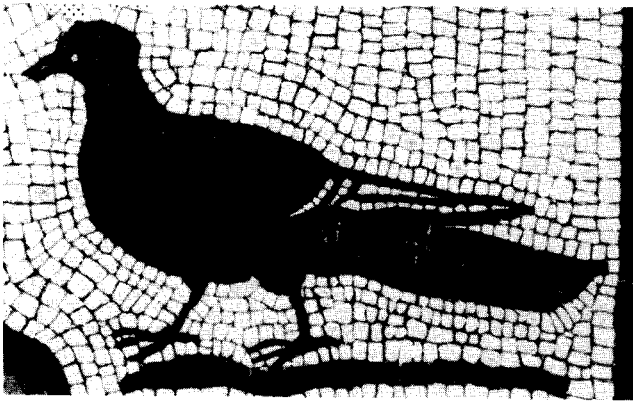
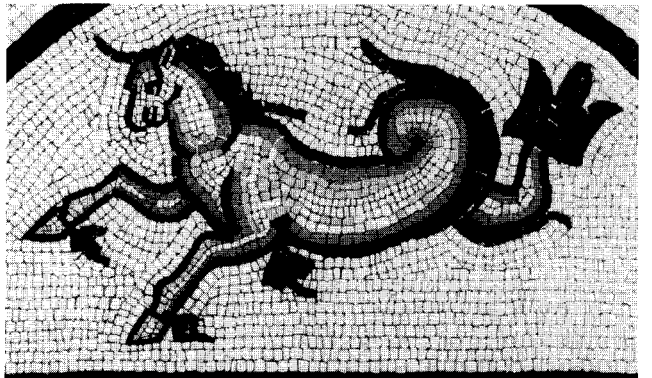
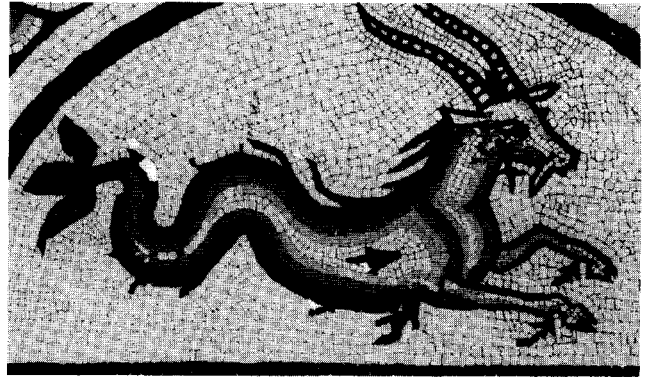


Fig 159 Painting of 'The Mosaic of the Wrestling Cupids' - details. [Pages 168-74]

Each of the lateral semicircles depicted, within a linear frame like that of the central panel, a lively imaginary marine creature (Fig 159). A sea-horse with convoluted body and a sea-goat have survived intact and there remain part of the head and the tail of a (?) sea-panther and the forelegs and part of the body of the fourth creature. Sufficient is preserved to show that diametrically opposite creatures faced in opposite directions.

The interspaces were each divided into four isosceles triangles, those flanking the lateral semicircles having a concave base. In two diagonally opposite interspaces these two triangles and that in the angle of the outer square are occupied by a pattern of alternately black and white contiguous triangles while in the fourth triangle is inscribed a colourful lotus in profile, depicted as opening towards the angle of the outer square. Of the other two interspaces only one remains entire, but it is almost certainly safe to assert that the other was patterned similarly. In that which is complete the two triangles flanking the lateral semicircle each contain a horizontal pelta superposed centrally on two others of the same size, side by side, the points of all three being towards the semicircle; the lotuses of the other two interspaces are here replaced by a pair of heart-shaped leaves linked by a U-shaped fillet, their tips pointing in opposite directions, and the fourth triangle is occupied by a black and white pattern of contiguous squares with alternate rows divided horizontally. The edges of black squares and triangles contiguous with the containing triangle are dentilled and the colours are counterchanged throughout.

Surrounding this design is a band of the white background 70 mm (2.8 in) wide, then a grey band 76 mm (3 in) wide, then a white band 380 mm (15 in) wide bearing a conventionalized scroll, then a grey band 90 mm (3.5 in) wide, then one of white 108 mm (4.2 in) wide, and finally one of grey 178 mm (7 in) wide. The scroll is a form of acanthus. A bird facing left perches in each of the axial spirals, and a heart-shaped leaf or a lotiform flower in profile, alternately pointing outward and inward, terminates the other spirals (Fig 159).

Close study of this mosaic has led Mr Crummy to believe (*see below*) that the principal components of its design were planned in multiples of two-and-a-half Roman feet, and also that, despite easily avoidable inconsistencies in execution, it was laid by the 'direct method', i.e. *in situ*, tessera by tessera (as opposed to other methods by which mosaics are produced in prefabricated sections). Be this as it may, and notwithstanding the inconsistencies, this is one of the best laid and most colourful, attractive and interesting Roman mosaics yet found in Britain. It bespeaks a master-craftsman possessing artistry as well as skill. This is especially well illustrated by his exploitation of available colours which in the cupids, animals and guilloche were carefully chosen to suggest a three-dimensional appearance. The limbs of the central figures are flesh-like in colour, outlined in light brown on their lighter side, in dark red on the darker, and highlighted in white. The surviving wing

is predominantly dark red and black with an orange highlight. The facing bird has orange and brown plumage but white primary wing-feathers, is outlined in dark red, and has orange legs and feet. The bands of shadow are ochre and the linear frame of the panel is black. The round-tongued double guilloche forming the enclosing inner square is orange, buff, grey, and white. In the lateral semicircles the sea-goat is white with a touch of orange in its body and is outlined in black; the sea-horse is white, grey, and orange. All have orange hair and tails. The lotuses in two of the interspaces are grey, black, white, and yellow with an orange serrated crest, and the pairs of leaves in the other two interspaces are white and yellow with an orange tip and black outline. The loops (including their tongues) in the double guilloche forming the outer square are outlined in black and are successively buff and yellow, brown and orange, grey and lighter grey, and pink and yellow. The surrounding dark bands and scroll are dark grey and black. The birds in the scroll on the east and west sides have orange, buff, and brown plumage with white highlights and orange beaks, legs and feet. Those on the north and south sides are grey and white with orange beaks, legs and feet. Although generally similar, no two are exactly alike either in colouring or in pose.

The two concentric squares, with the inner square 'supported' on semicircles developed from the sides of the outer, can be regarded as a hybrid design combining square and semicircular panels formed from two types of nine-panel design, one a rectilinear grid and the other composed of a central circle, four 'supporting' semicircles, four quarter-circles in the angles, and four concave-sided square interspaces (Smith 1975, 276-81). Such hybrids are few, but this particular instance has an exact parallel in Britain in the mosaic of Verulamium, dated to the late 2nd century, the central panel of which depicts a lion carrying in its mouth a stag's head (Neal 1981, no 75); and there, although the inner square is formed by a three-strand guilloche, the outer and its lateral semicircles are formed by a double guilloche differing from that of Middleborough only in having straight instead of round tongues. The subject of the mosaic of Verulamium, while paralleled abroad, is otherwise unknown in Romano-British mosaics, and the same can be said of the subject of the Middleborough pavement. This was clearly a pair of naked, wrestling boys, presumably both winged — in other words, cupids or *erotes*. The subject is rare in Roman mosaics, but a close parallel appears in a mosaic of Vienne (France) which has been assigned to c 150-200 (Lancha 1981, no 318, pl 59a) and another in a mosaic on the north Aegean island of Thasos which has been assigned to the end of the 2nd century or beginning of the 3rd (Garlan 1965).<sup>3</sup> In both the subject is depicted in a square panel and beneath the figures is a marked band of shadow; but its representation in the mosaic of Thasos is strikingly closer to that of the Middleborough mosaic not only in the stance of the wrestling cupids but also in the presence of two birds facing towards them, one on either side in a smaller panel contiguous with the

frame of theirs. Neither in this mosaic nor in that of Vienne are the cupids distinguished in any way, for example by differently coloured hair. In these two instances, therefore, the subject cannot certainly be identified as depicting the struggle between Eros and Anteros (for discussion and references see Garland 1965 and Lancha 1981, no 318); and, notwithstanding the loss of the upper parts of both figures in the Middleborough mosaic, the similarity between the representation of the subject here and in the mosaic of Thasos suggests that the Middleborough cupids were probably also not differentiated. This similarity includes the birds associated with the wrestlers, two in the case of Thasos and one at Middleborough. Their significance is problematical.<sup>4</sup> It may be worth noting, however, that, although one of those of Thasos was too damaged for its species to be suggested, the other was tentatively identified (but, as far as it is possible to judge from the published photographs, unconvincingly) as a species of crow. The colouring certainly rules out such an identification in the Middleborough mosaic, and indeed it is impossible to suggest the species here.

The marine creatures in the lateral semicircles are conventional motifs commonly depicted in the lateral semicircles of compass-drawn nine-panel designs (cf Smith 1975, 279-80). Yet they are not without interest as provincial polychrome developments from the immensely popular Italian black-and-white 'marine cycle' of the 2nd and 3rd centuries (cf, eg Blake 1936, 138-54; Becatti 1961, 310-16 and *passim*). In Britain the most closely comparable creatures are those of the mosaic of Room 7 at Fishbourne (Cunliffe 1971, 163-4, pls 47-9), now known to date from not earlier than c 160 (Rudkin 1981, 8). There, two are actually depicted in black on a white ground, clearly echoing contemporary Italian fashion, but the other two are polychrome. The execution of the Middleborough creatures is, however, much superior.

The decoration of the swallow-tailed interspaces has no significant parallel; and, although a solitary bird perches in one of the spirals of the scroll surrounding the mosaic at Fishbourne mentioned above (Cunliffe 1971, pls 47 & 53b), the Middleborough scroll and its four axial birds are unique in Britain and, as far as it is possible to ascertain, unparalleled in any of the Gallic or German provinces. In fact, the introduction of the birds places this scroll in the category of the 'inhabited scroll' which, although part of the Hellenistic contribution to mosaics of the Roman period (cf Levi 1947, 15-16, pl 5b; Baratte 1978, no 43), is relatively rarely found in Roman mosaics before the 4th century.

Two other features are noteworthy. One is the careful execution of the tongued double guilloche. In addition to the mosaic of Verulamium, mentioned above, parallels in Britain may be noted in the round-tongued double guilloche of the mosaic of Room 30 at North Leigh (Oxfordshire), the design of which is a variant of that of Middleborough and Verulamium (Smith 1975, 281, pl 122), and in the straight-

tongued double guilloche of the border of a mosaic adjacent to one at Silchester (Hampshire) which has been assigned to probably not earlier than c 140-160 (*ibid*, 275, pl 103, 1). The other noteworthy feature is the grey bands which surround the design. Such bands, of black as well as grey, are characteristic of 1st-century mosaics, such as those of c 75/80 at Fishbourne (Cunliffe 1971, pls 74-81), but in Britain persisted until at least the mid 2nd century (Smith 1975, 270-4, pls 107-27 *passim*).

As already noted the representation of wrestling cupids at Vienne has been assigned to c 175-200 and that of Thasos, which is stylistically closer to the representation from Middleborough, to the end of the 2nd or more probably the early 3rd century. The mosaic of Middleborough, however, is both aesthetically and technically much superior to either of these and it is impossible not to regard it as the earliest of the three. In short, having regard to the *terminus post quem* of c 150 for the construction of Building 70, and the evidence that the mosaic dated from later than this (*see above*), the pavement can most probably be assigned to c 150-175. Certainly, it must be one of the earliest mosaics of the 'Colchester-Verulamium school', and its quality adds weight to the suggestion that this school originated in Colchester (Smith 1975, 288).

#### Notes

1. I am much indebted to Mr Philip Crummy for inviting me to visit the Middleborough site when Building 70 had been fully exposed and while the mosaic in Room 7 was still *in situ*, and now also for the opportunity to contribute a report on this mosaic to his account of the excavation. The preparation of this report has been greatly facilitated by Mr Crummy's kind provision of photographs and colour slides of the meticulous painting of the mosaic by Mr R H Moyes as well as of the mosaic itself. It is intended that the mosaic will be on permanent display in the office block which is the headquarters of the Royal London Mutual Insurance Society Ltd and which now occupies the Middleborough site.
2. Dimensions give the north-south measurement first.
3. I am grateful to Dr Elisabeth Waywell for this reference.
4. It may be worth noting that four birds, apparently only decorative, appear in panels around a central representation of the contest between Eros and Pan in a mosaic of Vienne assigned to the mid 2nd century: Lancha 1981, no 323, pl 64. The subject is not altogether dissimilar from that of the contest between Eros and Anteros. ■

#### Errors in the design of the Mosaic of the Wrestling Cupids

[Fig 160, p 173; Fig 161, p 173]

The following is an extract from an article published in the 1980 edition of the *Bulletin de l'Association Internationale pour l'Etude de la Mosaïque Antique* (Crummy 1980b).

The positions of the ivy leaves and lotus flowers in the roundels of the acanthus scroll were carefully worked out in a logical fashion by the mosaicist. Although mistakes were made in the positioning of the flowers and the leaves, sufficient is correct to make clear the principles of the design. There are two types of ivy leaves and two types of lotus flowers making, apart from the birds positioned one in the centre of each side, four motifs in the scroll. On each side of the mosaic there are two groups of four roundels, one to

each side of the central bird, making a total of eight groups of four. It was also planned that leaves should alternate with flowers and that each of the four motifs should occur (a) in every group of four, (b) in the corner roundels of the mosaic, and (c) to the sides of each pair of opposing birds. In this way a balanced distribution of flowers and leaves was achieved. The following is one of several possible methods of working out the original distribution of motifs. It is unlikely that this bears much resemblance to how the pattern was originally conceived.

Let ♡ be A, ♣ be B, ♠ be X and ♤ be Y. The possible permutations of alternating leaves and

flowers with each motif occurring only once are

AXBY	BXAY	XAYB	YAXB
AYBX	BYAX	XBYA	YBXA

The arrangement which occurs on the mosaic is shown in Figure 160. (The permutations which are circled do not contain A, B, X, and Y and are where A and B do not alternate with X and Y.) Thus, reading in a clockwise direction, the following in the mosaic are *not* permissible: AYAX, XAYA, AYXB, and XBX Y; and the following *are* permissible: YAXB, YBXA, AYBX, and XBYA. These latter occur in the group of eight possible permutations listed above, leaving the following which should occur in the mosaic but do not: AXBY, BXAY, BYAX, and XAYB. BYAX must belong in position 4 (Fig 160) since of the four missing this is the only permutation to end with X, the latter being fixed by the adjacent XBYA. BXAY must belong in position 7 since this permutation begins with B, the only letter not to occur in a corner. XAYB must fill position 6 since this permutation ends with B. AXBY must belong in position 8 since this ends with Y and fills the last remaining space.

By comparing the intended with the actual distribution of motifs (Fig 161), two areas of mistakes can now be detected. At the top of position 4, the wrong type of leaf has been laid. This is a minor mistake, the short curved lines on the more elaborate form of the leaf having been omitted. Presumably this can be put down to carelessness on the part of the mosaicist concerned. However, the other mistakes are more serious and in effect result in almost an entire row being wrongly laid. Furthermore, two other errors associated with this row can be found. The leaf in the bottom left-hand corner was not laid to point towards the centre as it should, but treated like the others in the row. Also a short stretch of the adjacent scroll here runs anti-clockwise, not clockwise as it

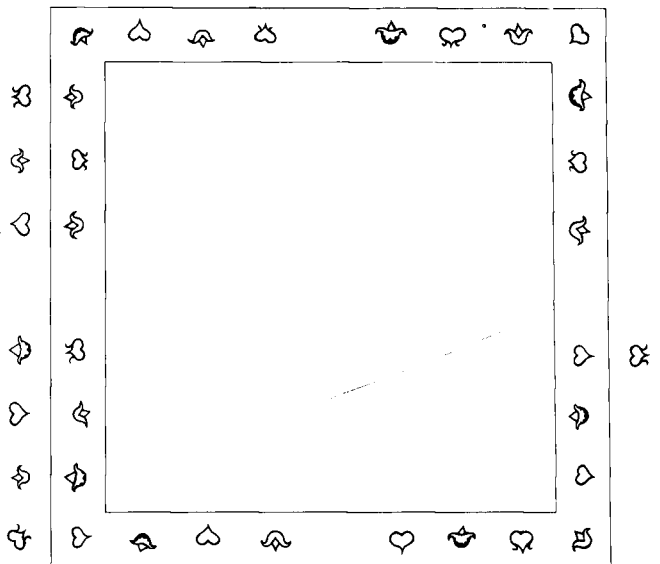
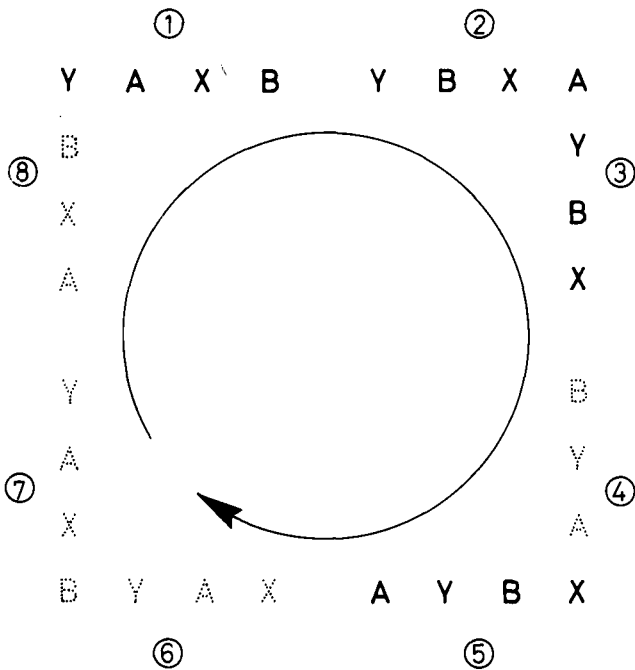
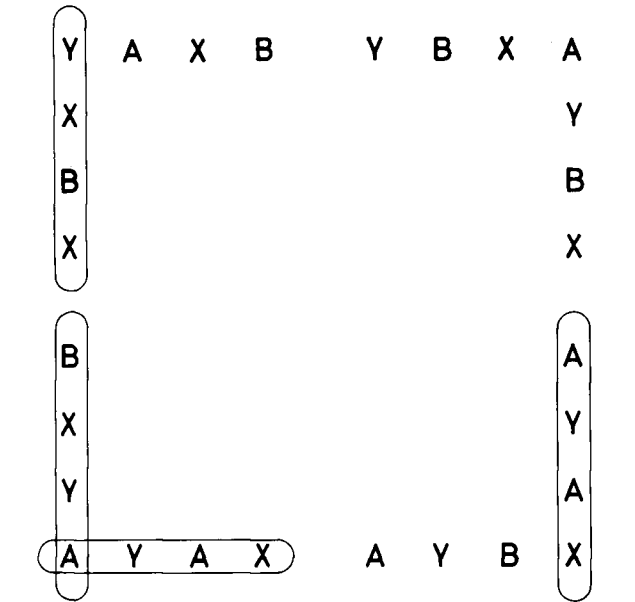


Fig 160 Schematic representation of motifs in border of 'The Mosaic of the Wrestling Cupids'. [Pages 172-4]

Fig 161 The actual arrangement of motifs in the border of 'The Mosaic of the Wrestling Cupids' with corrections around the perimeter. [Pages 172-4]



should. The implication of these mistakes is that the mosaicist laying this part of the pavement did not understand the design and therefore was not involved in its conception. Perhaps there were at least two mosaicists whose quality of workmanship is otherwise indistinguishable? Alternatively perhaps the mosaicist was using a design from a standard pattern-book which he somehow misunderstood and copied wrongly? The scroll in the bottom right-hand corner is thicker and clumsier than elsewhere; the stalk is two cubes thick unlike the rest of the scroll (Fig 158). Perhaps here can be detected another hand involved in the laying of the pavement, this time less skilled?

### The accuracy of the design of the Mosaic of the Wrestling Cupids

[Fig 162, p174]

The drawing of the mosaic (Fig 158, p169) is an accurate representation of the original since it is a photographically reduced tracing of it, drawn cube by cube. (For a description of the technique employed, see Crummy 1980b.) From this the following observations can be made. The pavement was designed so that its major components were multiples of 2.5 *pedes monetales* (Fig 162). It had not been set out with great precision; the greatest inaccuracy occurs in the central panel which is 30mm longer than it is wide. The linear lines in the design are almost perfectly straight and the right angles accurate to within one degree. The arcs of the

lunettes and the adjacent guilloche are close to true circles but the tesserae in these were less accurately laid than those which form the straight lines. Thus we can conclude that the pavement was laid out with care and precision although by no means perfectly.

### Building 71 (Period 3)

[Plan Fig 163, p175; detail plans Fig 164, p177, & Fig 165, p178; structural development of building Fig 167, p180; photograph Fig 166, p179]

Building 71 was constructed on the north side of the gravel street probably during the 2nd century (Fig 153). Much of what survived of this building lies under Sheepen Road and therefore was not available for excavation. The part examined consisted of five rooms and a passage (Fig 163). The work was limited to recovering the plan and exposing the floors of the building by removing debris left after the demolition of the daub walls. The debris survived in Rooms 1, 2, 3a, and the passage. Other Roman layers were excavated in Rooms 4 and 5 and in the stoke hole (F920); all other deposits excavated including those on the site of Room 3b were of post-Roman origin. Much, if not all, of the floors exposed had been tessellated but little escaped the demolition intact. In large areas, the demolition debris directly overlay the mortar base of the pavements indicating that most of the tesserae had been stripped off at this time.

The rooms had not all been built at the same time. Originally there had been Rooms 1, 2, 3a and the

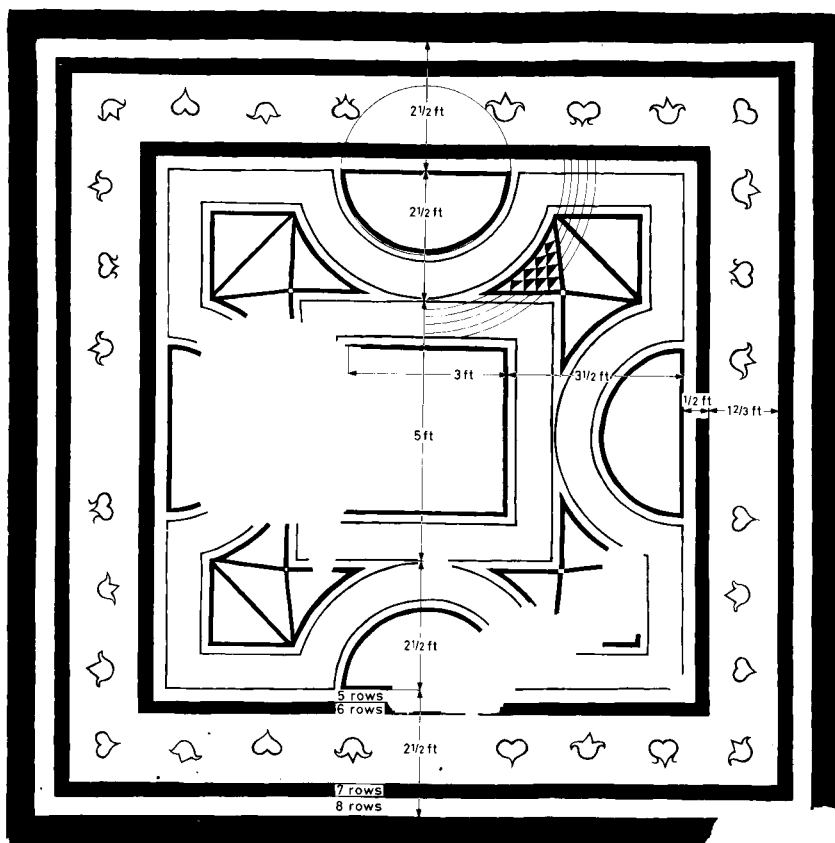


Fig 162 The dimensions of the 'The Mosaic of the Wrestling Cupids'. [Page 174]





passage to which, apparently to provide baths, were later added Rooms 4 and 3b, the latter being in effect an enlargement of Room 3a. The relationship between the two alterations is obscure; one may have followed the other or they may have been contemporary. Later still, Room 5 was added to the south side of Room 4 and to the east side of Room 3.

The *opus signinum* bases for the tessellated floors of Rooms 2, 3a, and the passage largely survived although most of the tesserae had been removed. Probably the floors in these rooms had been of plain red tessellation although the surviving tesserae were so placed that in any of these rooms there could have been a small mosaic which had been destroyed without trace. Substantial parts of a quarter-round moulding lay around the edge of the floor in Room 2 and traces of another were detected in Room 3a. In Room 1, the *opus signinum* base was observed in section and, although no tesserae were *in situ*, it seems likely that this had been tessellated. The foundations, although extensively robbed in the early medieval period, were constructed of roughly coursed blocks of septaria and greensand set in hard, light brown mortar. As testified by the demolition debris, the walls themselves had been largely if not entirely of daub and possibly timber.

The south wall of Room 3a (F934) was demolished to foundation level and replaced by the timber-framed extension Room 3b. The floor of Room 3b was about 90 mm higher than that of Room 3a so that in effect a low dais was formed, the step between the two floors being taken up by the quarter-round moulding on the south side of Room 3a (Fig 164). In Room 3b, the floor had been mostly of plain red tessellation but with a strip of mosaic along its northern edge overlying the foundation of the south wall of the room in its original state. In the early medieval period, the foundation was robbed and the mosaic destroyed except for a small fragment which was *in situ* on the south side. Using this fragment and a loose piece which lay near the top of of the fill of the robber trench, it is possible to make a tentative reconstruction of the plan of the pavement (*see report below*).

Part of the east wall of Room 3b survived in the form of a strip of white mortar 250 mm thick with a distinct 170 x 180 mm hole or socket in it. The inner western face of this wall was plastered. It was later thickened by the addition of a similar wall (F851) to its eastern face when Room 5 was built. The addition was 250 mm wide, made of reused mortar rubble, and had a socket or hole in it 140 mm square. The two strips of mortar were probably mortar ground-plates with upright wooden studs set into them (hence the square holes). Whether they were original or replacements for decayed wooden ground-plates is obscure although the fact that there were two strips rather than just one favours the first possibility. Within the area of Room 3b and under the mosaic was an L-shaped foundation of tile and mortar. It was on a slightly different alignment from Building 71 and probably predated it.

Room 4 contained a hypocaust, parts of which were still *in situ* (Figs 165-6). The walls of the room had

been extensively robbed except in the south-east corner where, above foundation level, there was a course of Roman building tile capping one course of mortared, roughly-squared, greensand blocks. The foundations were of mortar and greensand. They were on average 650 mm thick and of unknown depth. They were sturdier than the foundations of the original rooms of the building and thus, in contrast, may have had a stone superstructure as apparently indicated by the fragment of masonry in the south-east corner.

The sub-floor of the hypocaust was a layer of *opus signinum* 60 to 70 mm thick laid with the east, west, and south sides sloping towards the centre so that the latter was 300 mm below the level of the edges of the floor. That the slope was not simply a result of settlement is made clear by the *pilae*, the tiles of which were all more or less horizontal. Moreover the relationship between the lowest tiles in each *pila* and the mortar of the sub-floor proved conclusively that the *pilae* had been set at an angle to it (apart from those in the centre). The slope was presumably intended to facilitate drainage. Originally there were 36 *pilae* arranged in six rows of six. They were built of tile measuring approximately 180 x 180 x 30 mm with the exception of the two next to the stoke hole which were constructed more sturdily of tile 370/400 x 270 x 30 mm. Of the latter, the western *pila* had a fragment of iron in its east face approximately 100 mm from its base. This consisted of a short spike set in a mortared joint and may have been the remains of an iron grill across the mouth of the hypocaust. Whatever its function, it was perhaps the need to support this ironwork which may explain why these two *pilae* were larger than the others. Alternatively, they may have carried a steam tank or a hot bath, both being features found in this position in baths elsewhere. For each *pila*, the height and number of surviving tiles are shown in Figure 165. Although nothing survived of the suspended floor, it was probably level with the floors of Rooms 1, 2, 3a, and the passage.

The surviving fragments of the arch of the stoke hole indicate that it must have been about 440 mm wide. Butting onto the outside of the north wall of the room were two substantial piers between which lay four flat tiles forming the floor of the *praefurnium*. To the north of this was the stoke pit, the whole forming a rectangular area F920. The tiles in the stoke hole and in the northern half of the centre of the sub-floor were very burnt, those under the arch being the most burnt and discoloured of all. To judge by the extent of the discolouration and cracking immediately south of the stoke hole, it is clear that, in this area, the suspended floor must at times have been extremely hot.

A few corroded fragments of thin flat iron sheet lay in the stoke hole, the largest being about 100 mm across. These may have been part of one of the following: the iron structure between the two large *pilae* or a boiler over the top of the two external piers forming the *praefurnium* or a fire-door for the mouth of the latter. There was no evidence of any structure enclosing the *praefurnium* which, apart from any

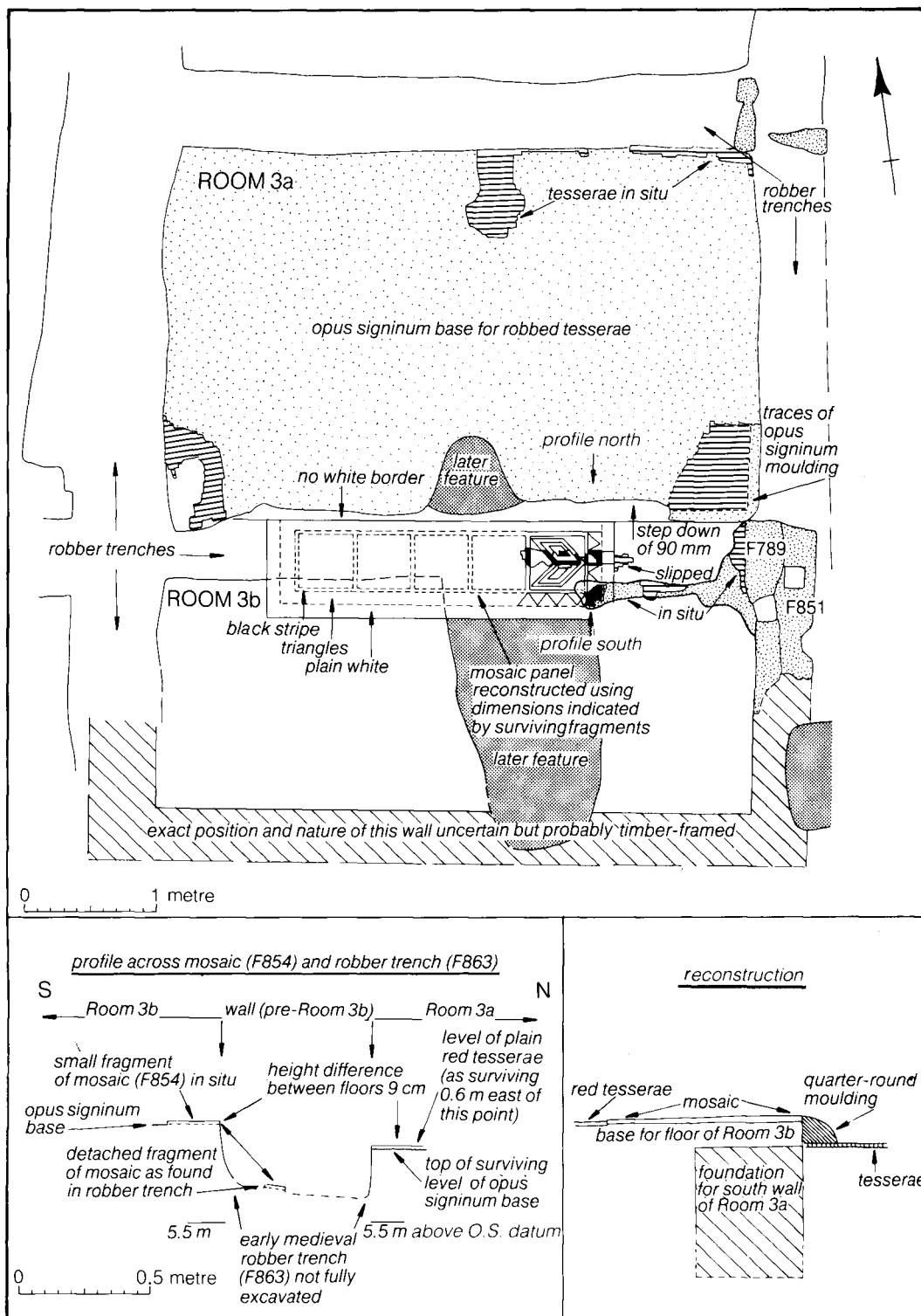


Fig 164 Room 3a/b of Building 71. [Pages 176 & 179-80]

protection afforded by the eaves of the building, must presumably have been open to the elements.

All that survived of the floor of Room 5 was a small patch of mortar near the centre of the room and a tiled channel (Fig 165). The latter almost certainly implies the previous existence of a hypocaust in this room because it is very similar to the possible drains found in the centre of the hypocausts on Building 19 at Lion Walk. Not enough of the channel survived to

determine which way it sloped (as it must have done if it had been a drain). However the height of the channel makes it clear that the suspended floor in this room, of which there was no trace, must have been above the level of the floors of the adjacent rooms. As described above, the wall on the west side of the room was timber-framed and thus it seems likely that the walls on the south and east sides of the room, being contemporary with that on the west side, were of a similar construction. The way in which the north end

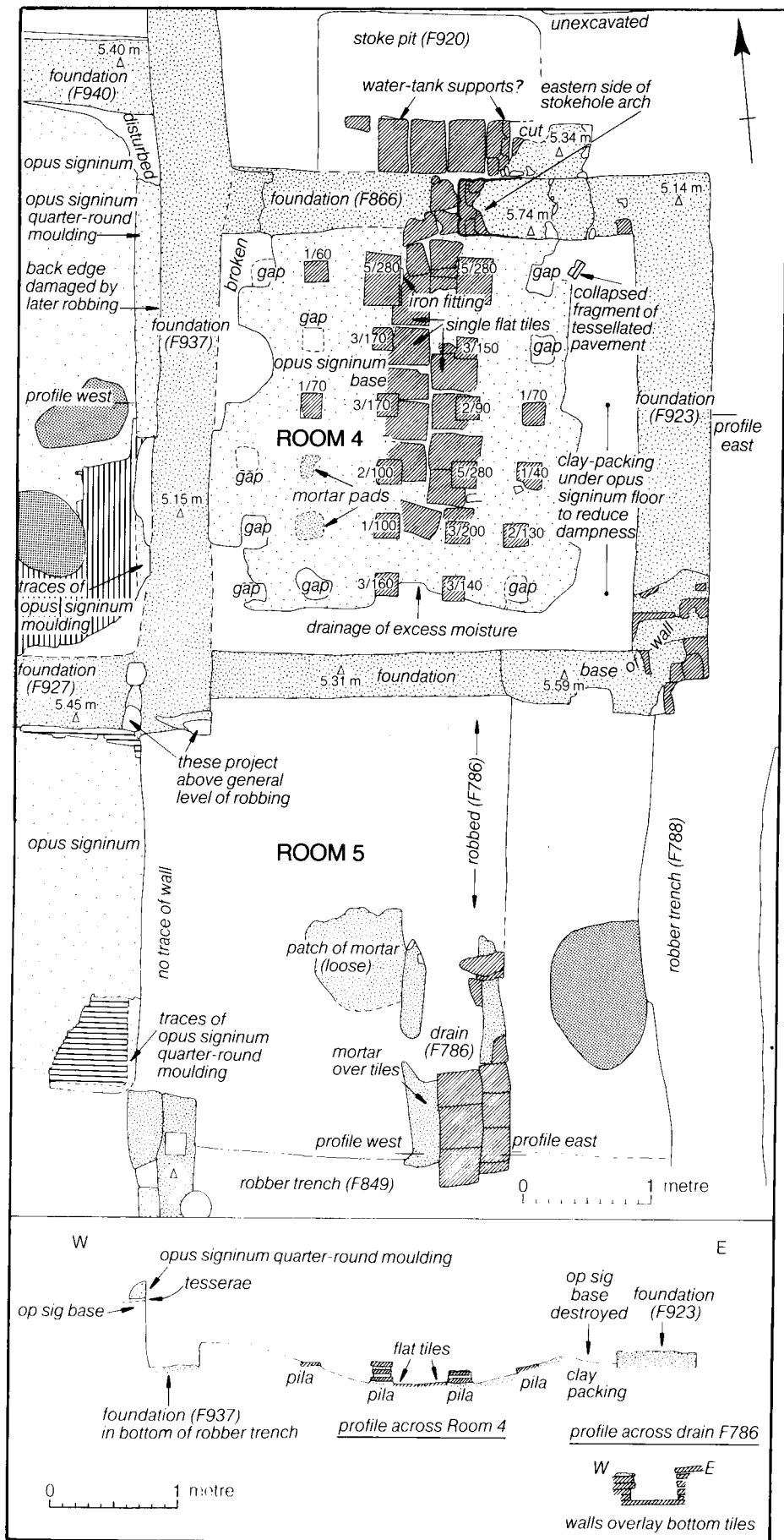


Fig 165 Rooms 4 and 5 of Building 71. [Pages 176-9]



Fig 166 Rooms 4 and 5 of Building 71 viewed from the north. [Pages 176-9]

of the robber trench of the eastern foundation of Room 5 was offset to the east wall of Room 4 suggests that Room 5 was a later addition. This conclusion is reinforced by the fact that the wall between Rooms 4 and 5 resembled the east wall of Room 4 and seemed to be of one build with it.

A major problem with the hypocausts must have been the seepage of ground-water into the sub-floors. A section cut in 1979 through a dried-up part of the bed of the river Colne about 500m upstream from Middleborough showed that the bottom of the river in the 1st century had been at a height of 2.6 m above Ordnance Survey datum suggesting that the sub-floor in Room 4 which was at a height of 4.6 m must have been susceptible to flooding from ground water. (Indeed throughout the excavation of Room 4, it proved difficult to keep the sub-floor free of seeping water.) Various steps had been taken to eradicate the problem. The sub-floor was set on a thick layer of solid clay. This was observed to the east of the east wall of the room and appeared to extend under the floor. Its thickness could not be determined but on the surface it showed as a band of clay about a metre wide. The sub-floor itself had been twice lined with clay in further attempts to control rising water. The sequence was as follows. Directly on the mortar surface there was a layer of charcoal originating from the first period of use of the hypocaust. This was

sealed by a layer of clay about 120 mm thick (in the centre of the room) on which there was another thin layer of charcoal indicating the continued use of the system. Sealing the second layer of charcoal was another layer of clay 140 mm thick representing a second attempt to control the water. No charcoal was found over this layer of clay but possibly it had been lost through erosion since the second clay layer was the highest surviving deposit in the room. In the light of these layers, the decision to make the sub-floor of Room 5 higher than that of Room 4 can be seen as an attempt to avoid the water problem altogether in the new room. Just how it was possible for the sub-floor of Room 4 to be lined with clay is not clear since there would have been very little room below the suspended floor. Perhaps the latter was breached to allow the access necessary or possibly it was replaced with a new floor at a higher level.

To the south of Building 71 and probably contemporary with it were two wooden water-mains (F755 & F756) which had been laid along the centre of the street. The pipes were not traced south of the position shown in Figure 163 but their course northwards towards the south wall of Room 5 was indicated by the alignment of the mains and the continuation of the clay strip (L333) in which the pipes were set. The mains, where these survived, showed as brown stains like those at the Balcerne Lane site (pp 115-7); no collars were found.

In Figure 167 is shown the most likely sequence of development of Building 71. For Phase 2 this is uncertain since at this time there appears to have been no separate *caldarium* or *tepidarium* indicating that in this phase either Room 4 had been not a *caldarium* but a *laconicum* or that the functions of both were provided by one room (ie Room 4), an arrangement which was rare if not unparalleled (Rook 1975). Another unusual feature is the apparent absence of any plunge baths. Room 3a can probably be discounted as a candidate for this role because it does not seem to have been capable of holding water.

### The mosaic in Room 3b

by D J Smith

Room 3 originally measured 2.8 x 4.5 m (9ft 2in x 14ft 9in).<sup>1</sup> When enlarged to the south, forming 'Room' 3b, the north-south dimension became 4.9 m (16ft 1in). The floor of the enlargement was 90 mm (3in) above that of the older floor, forming a step extending across the new room. It was paved with red tesserae approximately 30 mm (1.2 in) square except for a panel of mosaic of black and white tesserae, approximately 15 mm (0.6 in) square, laid almost centrally along the step (Fig 168). The panel appears to have measured 2.62 x 0.74 m (8ft 7 in x 2ft 5 in). Its north side was flush with the edge of the step and its east and west ends were respectively 0.99 and 0.80 m (3ft 3in and 2ft 7in) from the east and west walls of the enlarged room.

There remained of the panel only a fragment 0.71 m (2ft 4in) long at the east end and another, much smaller, at its south-east angle. From these the

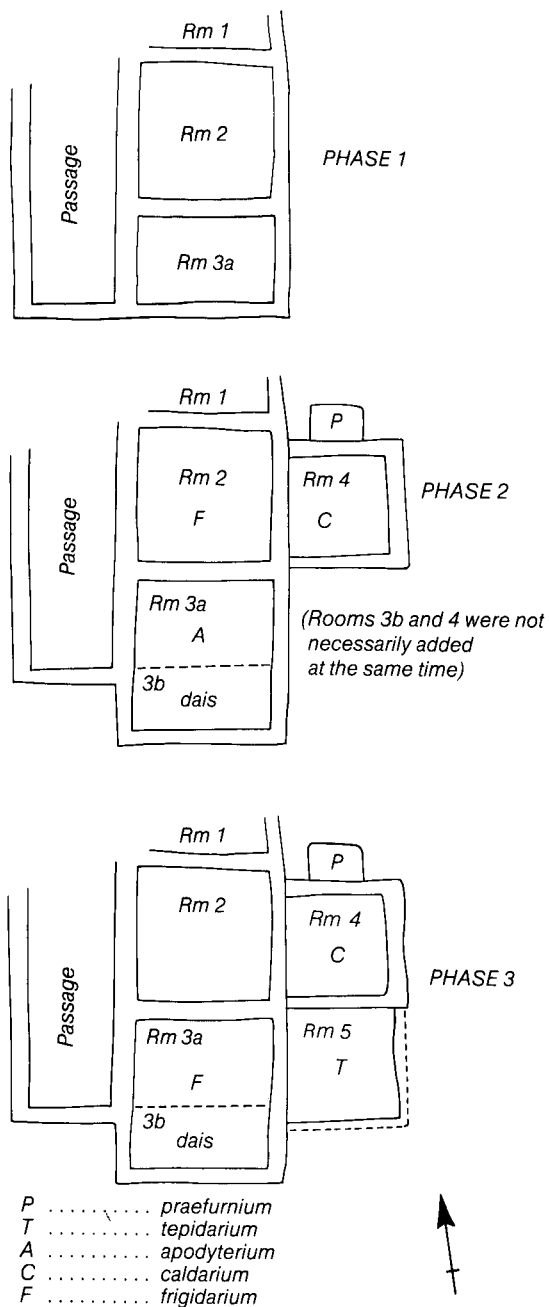


Fig 167 The development of Building 71. [Page 179]

pattern apparently comprised a row of five contiguous open squares formed by double rows of black tesserae with, except on the north side which remained white, a border of contiguous inward-turned stepped black triangles. Outside this border was a plain white band. The square at the east end appears to have contained a pair of open lozenges formed of double rows of black tesserae and juxtaposed to form a chevron pointing eastwards. Each lozenge contained a solid central lozenge of black. Such a pattern could be of any period from the 1st century even to the 4th, but the white surround with no enclosing border suggests an earlier rather than a later date.

**Note**

1. Dimensions give the north-south measurement first. ■

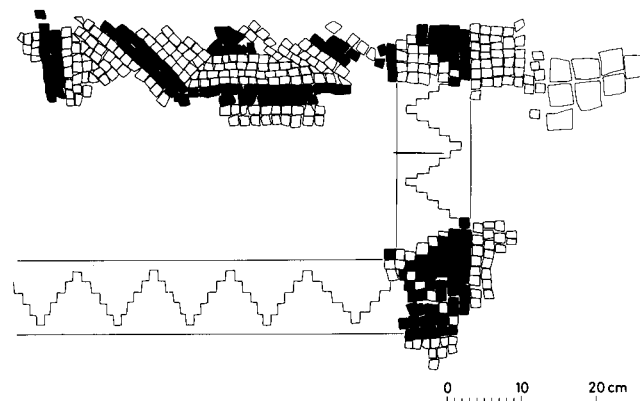


Fig 168 The fragment of mosaic in Building 71, Room 3b. [Pages 179-80]

**Building 72 (Period 3)**

[Plan Fig 163, p175]

Adjacent to the east side of Building 71 was a complex of features which appeared to represent the corner of a building of uncertain character (Fig 163, p175). This may have been either part of Building 71 or the corner of a separate structure. Four probable robber trenches were excavated (F554, F771, F776, & F778) plus a Roman foundation (F772), a slot possibly for a ground-plate (F782) and a posthole in a post-pit (F557). Little useful dating evidence for the building was found but on stratigraphic grounds it must have been contemporary with Building 71.

**Building 73 (Period 3)**

[Plan Fig 153, p164]

Only two rooms and an east-west passage were exposed of Building 73 (Fig 153). These lay under the remains of Building 76 and represent the latest Roman occupation in this part of the site. The rooms had tessellated pavements and the floor of the passage was of daub. The mortared foundations of the western room had been robbed during the early medieval period whereas the others survived.

**The area immediately north of Building 70**

[Plan Fig 153, p164]

This area was not examined in any detail although limited surface cleaning of the latest Roman deposits indicated no robber trenches or foundations. On the other hand, the north side of the northern robber trench of Building 70 showed the presence of substantial layers of make-up and occupation so that the existence in this area of buildings akin to Buildings 67 and 69 seems likely.

**The wall plaster from Middleborough**

by Roger Ling

The remains of wall-paintings from the Middleborough site seem to have all derived from simple panel-decorations or linear schemes; there is

no evidence for figurative work, and almost none for vegetal ornament. The fullest evidence comes from Building 69 (second quarter of the 2nd century). Here parts of dados and baseboards were found in position, decorated in the normal Romano-British manner with splashing on a coloured ground, a device intended to give the effect of marble or other variegated stones. In only one room (Building 69, Room 4a) was sufficient plaster preserved for a clear idea of the decorative scheme to be obtained (*see below*).

### Building 67

The statistics, for what they are worth, suggest predominantly red-ground decorations, but the sample is much too small to have any real value (Appendix 6, Table 2, microfiche). The only fragment with more than one colour shows red and white surfaces (the latter originally overpainted black?) separated by a white stripe.

### Building 69 (p 159)

The plaster here falls into two main groups: (1) plaster found *in situ*, ie attached to standing stumps of walls or lying in large pieces where fallen; (2) loose fragments (Appendix 6, Tables 3 & 4, microfiche). The former group is much the more important, and the latter adds very little information, except to emphasise the predominance of red in the decorative schemes.

*East wall of Room 4a (F943).*<sup>1</sup> In position there was a pink baseboard approximately 0.10 m high (including a quarter-round moulding at the bottom) surmounted by yellow panels on a black ground. Above this the larger pieces fallen from the wall can be easily reconstructed to give a scheme of large rectangular panels formed by green borders 25 mm wide on a continuous red ground (Fig 150, p 162). The panels, to judge from one piece, were about 0.31 m (approximately 1 *pes monetalis*) apart, and their width can be calculated at between 1.08 m and 1.20 m. Their height is unknown.

Schemes of red fields with green borders are very popular in the wall-painting of Britain and the other north-western provinces during the late 1st and 2nd centuries, the borders being normally, as here, edged with white lines. Only a few examples need be cited: decorations from the Period 1 timber building at Boxmoor (Hertfordshire), from a shop in *Insula V* at Cirencester (Gloucestershire), from a building inside the north-east defences of the fort at Malton (Yorkshire), and, on the continent, from Temple II at Elst (Holland) and from a house under the Imperial Baths at Trier.<sup>2</sup> In all these examples, however, the spaces between the red panels are painted black (and in most of them these black intervals carry more or less elaborate forms of candelabra). Only in one building do I know of schemes where panels and intervals have the same colour: that is House XXI.2 at Verulamium (Hertfordshire: cAD 180), where the end-wall of Corridor 2 was painted red with panels outlined by yellow and purple (?) borders, and the walls of Room 4a were green with panels outlined by

red borders. The borders were in each case 25 mm wide and edged with white lines.<sup>3</sup> The decorators at Verulamium in this case obviously shared the same general fund of ideas as those at Colchester a generation or so earlier.

A series of fragments found close to the main pieces of the Room 4a decoration show (1) the transition from a red surface to a white surface, the two colours being separated by the familiar green border, here 30 mm wide, and here between white and black lines; (2) a white zone 82 mm wide decorated with three parallel stripes of pale olive green, respectively 6 mm, 12 mm, and 22 mm wide; (3) part of a black band at least 25 mm wide (Fig 169.4, p 181). The best interpretation of these elements is that they formed a sequence leading from the main to the upper zone, and that the olive green stripes on the white background are intended to suggest the shadows of an imitation stucco cornice.

One or two other fragments are more difficult to explain:

(a) Fig 169.1. A green border of the familiar type separates a red surface on one side from a yellow

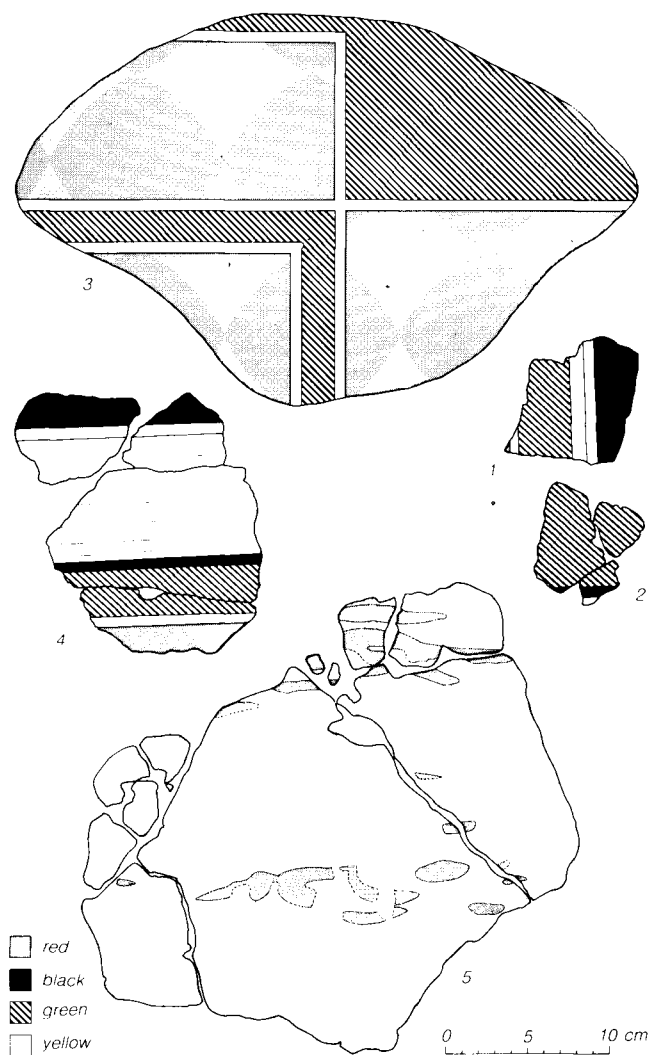


Fig 169 Wall plaster from Building 69. [Pages 181-2]

stripe (8 mm), a white line (5 mm), and a black band (at least 27 mm) on the other. Vertical frames at the end of the wall?

(b) Fig 169.2. A green surface at least 65 mm wide, separated by a black line 6 mm wide from a white surface: slightly convex. From a door or window reveal?

(c) Fig 169.3. Most curious of all, a piece in which the corner of a green border touches the corner of a green area forming a rectangular projection from a continuous green zone. Since it is impossible to find any logical role for this in the decoration as at present reconstructed, we can only conjecture that it is an anomaly caused by a door or window frame or some other architectural feature which disrupts the regular scheme.

*East wall of Room 5.* A fragment of a pale yellow dado with red splashes survived in position to a maximum height of 0.25 m. A trace of a vertical brown stripe indicated that it was divided into panels.

*North and south walls of the passage.* Fragments of a pink dado with dark red splashes survived in position. At one point on the south wall this dado was surmounted at a height of 0.30 m by a greenish-black band at least 50 mm high.

The small fragments from Building 69 again indicated a predominance of red (0.55 sq m), but the amount of white present (0.18 sq m) indicated that at least some parts of the decorations (eg the upper zones), or perhaps some whole rooms, were white-ground.

### Building 70

As in Building 67 the samples are very small, and no firm conclusions can be drawn; but the predominant colour was again red, which was roughly twice as plentiful as white (Appendix 6, Tables 5 & 6, microfiche). Only in Passage 2 was this relationship reversed, white being twice as plentiful as red; but here the figures are distorted by a pilaster which had collapsed into the central part of the passage still carrying much of its white plaster. A piece of plaster painted yellowish brown with red splashes, perhaps from a dado, was found in Room 3 (Fig 169.5). There is possible evidence of two phases of decoration in Room 7.

### Building 71

The samples measured are minute, and so the statistics are hardly meaningful (Appendix 6, Table 7, microfiche). The largest pieces show red bands and lines on a white ground. One small fragment has green markings, perhaps a plant, on a white ground.

### Notes

1. Davey & Ling 1982, 101, no 11.
2. Boxmoor: Neal 1976, 58, 88, pl 26, and frontispiece. Cirencester: Davey 1972, 259-60, fig 5. Malton: unpublished. Elst and Trier: Barbet 1974, 126-32, figs 18, 19 (with further bibliography). For all these sites, see also Davey & Ling 1982, 82-4 no 2, 97 no 8, & 145 no 28.
3. Davey & Ling 1982, 179-81, no 41, E-F. ■

## Roman pottery kiln and timber wells

[Location plan Fig 144, p 156]

During 1979 a close watching brief was maintained while building work was in progress. Observations led to the discovery of a Roman pottery kiln and three timber wells. Also the conjectured course of the Roman street was confirmed (Fig 144). Only one of the wells produced dating evidence; the latter indicates that despite their proximity to the kiln, at least one, if not all three of the wells, were of later date (see Appendix 13, microfiche).

### Timber wells

[Location plan Fig 144, p 156; plan Fig 170, p 183]

The most complete of the three timber wells is illustrated in Figure 170. Most of this well had been dug away by the contractors and only the two lowest stages survived where, because of the waterlogged conditions, the timber was well preserved. The well had been neatly designed and carefully made of oak. The ends of each board were cut to make a butt joint with its neighbour. Some of the boards were chamfered (Fig 170). A small upright post was *in situ* at the north-west corner. If this had been part of the original design then the symmetry of the existing boards implies that eight of these posts would have been required, two to a corner and each presumably nailed in place. No nails were found but this may be fortuitous. To judge by the level of the nearby kiln, the well would originally have had about six stages to bring it to contemporary ground level. It was set into the water-bearing gravel by exactly the depth of the lowest stage. The pottery from the fill of the well indicated a mid 2nd- to 3rd-century date for its abandonment, although the group is not reliable since it was partly dug out by the contractor's workmen.

The other two wells were very badly damaged. Only the bottom stage of each survived. These were set in the same natural gravel stratum as the first well. The northern well appears to have encroached on the street but the exact relationship between the two is uncertain.

### The pottery kiln F1019

[Location plan Fig 144, p 156; plan Fig 171, p 184]

The kiln was of Flavian-Trajanic date. It was well preserved apart from the stoke hole and stoke pit which had been partly destroyed by the contractor's mechanical digger. The general proportions of the kiln are shown in Figure 171. The perforated floor was of daub and was supported on a square-ended central tongue which was bonded into the rear wall of the kiln. Examination of the stratigraphy indicated the following sequence.

a) A layer of yellow sandy clay (L595) was laid down on the natural grey clay over an area of 10 x 4 m. In places this layer sealed a thin spread of charcoal fragments.

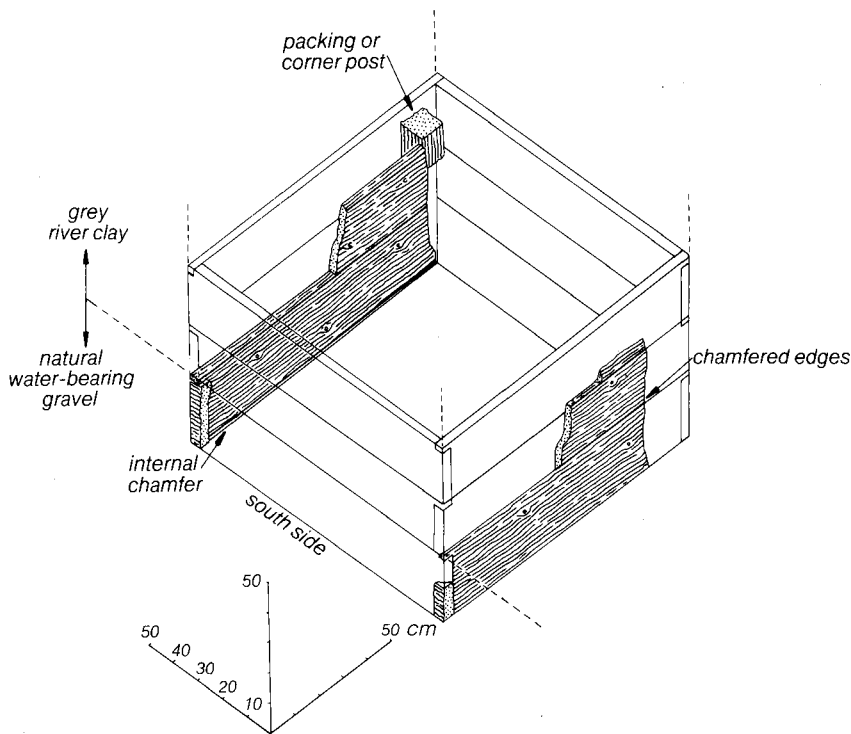


Fig 170 The timber well (F1020). [Page 182]

b) A mixed brown loamy clay (L594) was then dumped on top. This contained small lumps of daub and fragments of oyster shell. The ground-level was thus raised up to 4.95 m. The kiln (F1019) was dug through the dump so that its lowest point was 0.9 m below contemporary ground level. A pit (F1024), 1.1 m deep and over 2 m wide, was dug 3 m from the kiln but aligned along its long axis. It contained lumps of crushed burnt daub. Over the backfill of the pit accumulated a layer of broken, crushed daub (L593) which probably derived from a modification or the destruction of the kiln.

c) The kiln was itself backfilled and a rectangular daub 'platform' (F1021) was constructed directly over the top at the contemporary ground level. Although this feature seems to have contained much daub which had already been burnt, part of its low surrounding wall (Fig 171) showed signs of having been burnt *in situ*. Not enough of the feature survived to establish its function. It contained a small quantity of pottery of the late 1st century.

d) The daub platform became redundant and a layer of topsoil (L585) accumulated over it.

The products of the kiln are summarised in Appendix 13 by R Symonds (microfiche). Detailed publication of this material will be included in the volume of the *Colchester Archaeological Reports* to be devoted to the Roman pottery.

## The Roman street

[Plan Fig 144, p156]

The street, which apparently led from North Gate to Sheepen, was of two distinct parts (Fig 144). The first

section was from North Gate to the south end of Building 71 and the second part was its continuation westwards to Sheepen at a slightly different angle. Repeated resurfacing of the first of these resulted in an accumulation of metalling to a depth of well over a metre (Sx 92, microfiche) whereas west of Building 71 the street was at the most 0.65 m thick. The difference in the thickness and the awkward change in direction suggest that it was an addition which had been little used. It is odd that Building 71 was not aligned on the street and appears to have substantially encroached on it. The street was probably Flavian in origin for the reasons previously given (p11).

## The post-Roman burials

[Location plan Fig 172, p185; detail plan Fig 173, p186]

The remains of four adult inhumations lay without coffins in shallow, east-west graves (Figs 172-3). Three had their heads to the east (F214, F308, & F770). The burials are difficult to date closely. They are post-Roman since they cut the topsoil which sealed the latest Roman buildings and they probably predate the early medieval pottery industry since none of the pottery from this period was found in the fills of the graves. Burial F308 was in a context stratigraphically equivalent (more or less) to Building 74 which was early medieval; if the burial had been earlier than Building 74 then it is unlikely to have been by much. Thus the group probably belongs to the 10th or the 11th century. Graves F214 and F770 contained some iron objects (?nails); they are probably residual Roman (Fig 173).



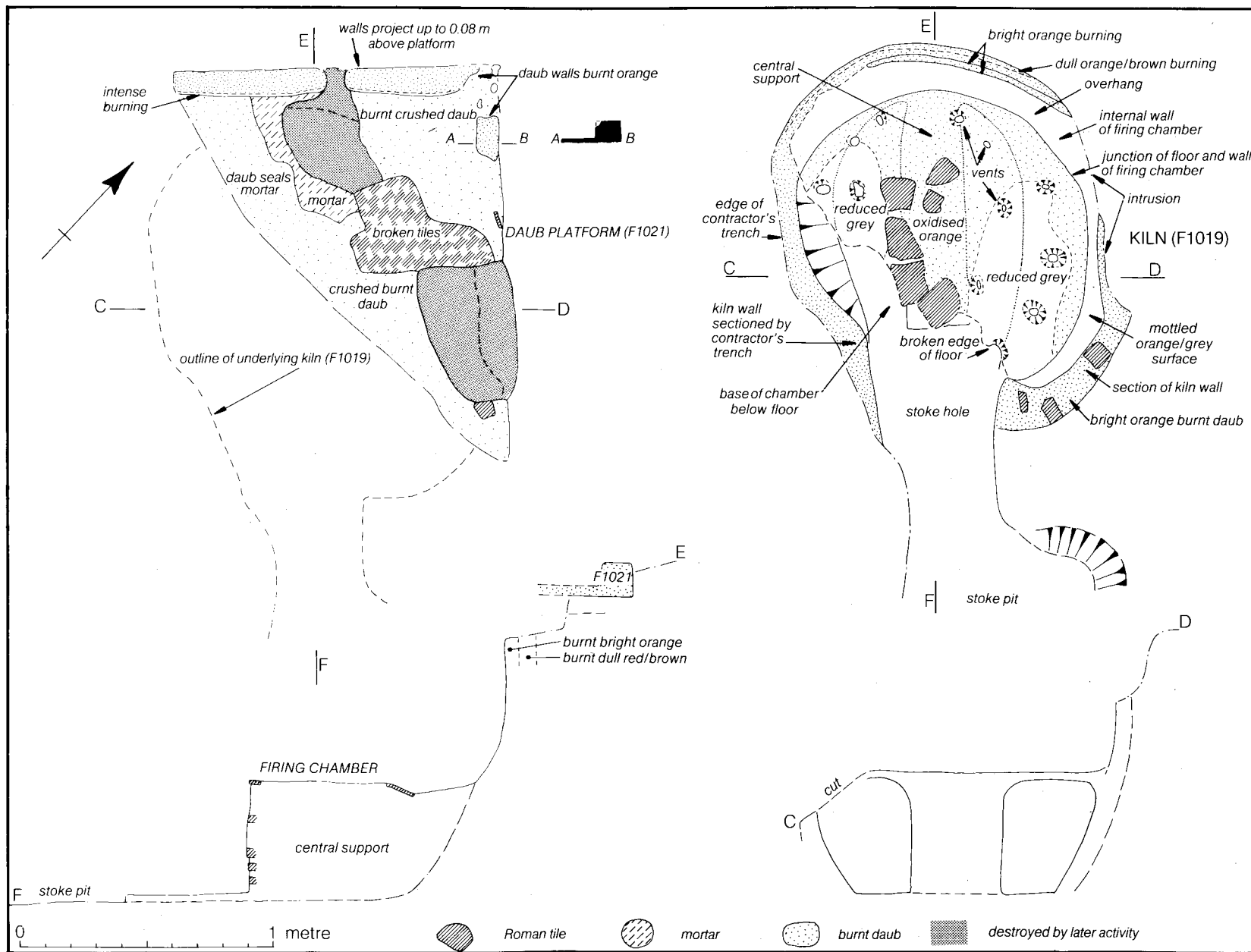


Fig 171 The pottery kiln (F1019) and the later structure (F1021). [Pages 182-3]

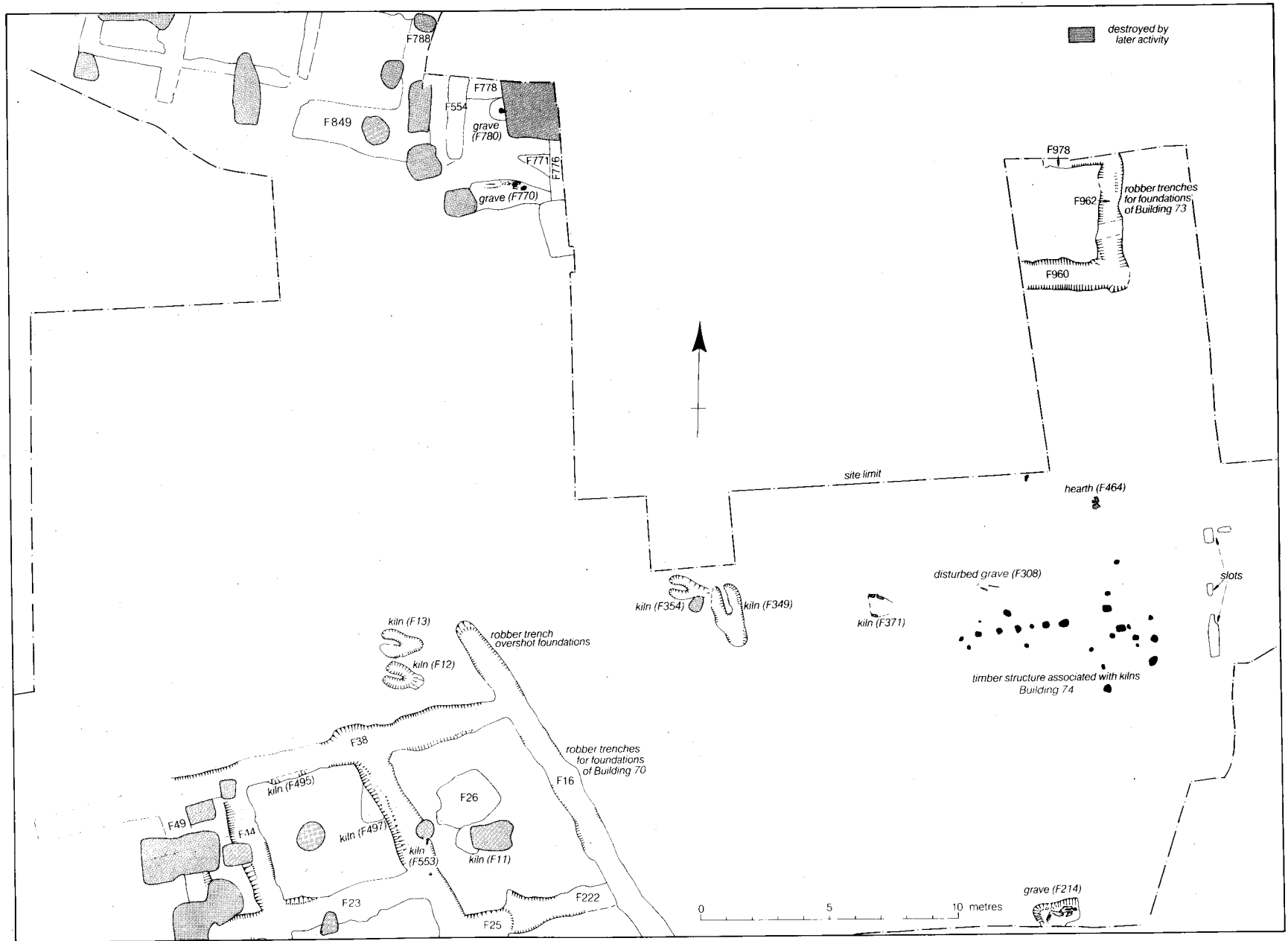


Fig 172 The earliest post-Roman remains (burials, robber trenches, kilns, and Building 74). [Pages 183- 9]

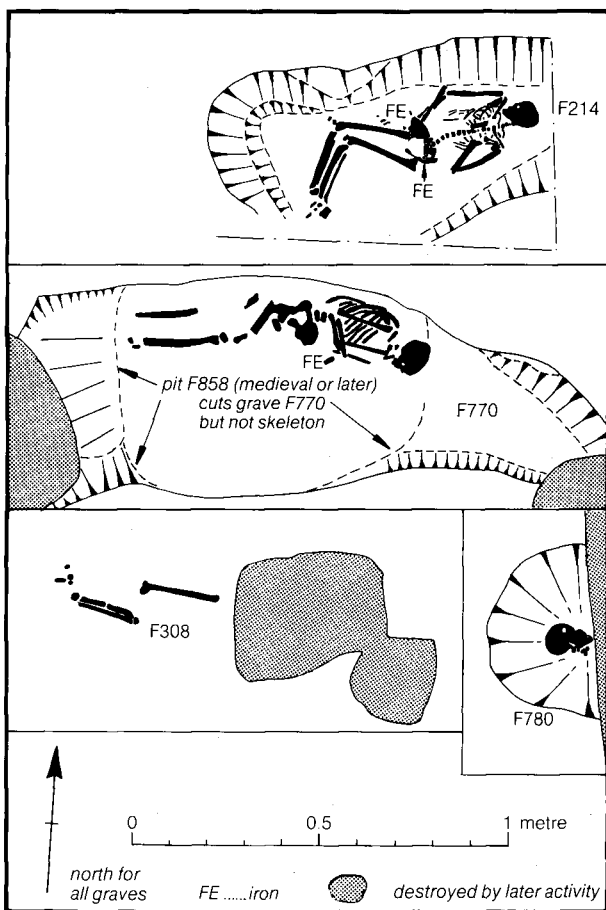


Fig 173 Post-Roman burials. [Pages 183, 185-6]

### The skeletal remains

by R Luff

#### Grave F214

The human remains from F214 comprise an adult female at least 45 years of age. Apart from a few small breaks the skull is intact. The maxilla and mandible show a considerable degree of alveolar reabsorption through periodontal disease and there is a fair amount of calculus deposit both on the upper and lower teeth. Most of the post-cranial skeleton is present except for some bones from the limb extremities. Estimation of stature was calculated using the equations of Trotter and Gleser (1952, 1958) and gave a value of 5ft2 in. Three fragments of animal bone were found in the grave: two proximal radii from a sheep/goat and a pig, and a cow skull fragment.

#### Grave F770

This grave was subjected to disturbance in earlier times since some of the post-cranial skeleton is missing and several bones exhibited old breaks. Missing bones include one cervical vertebra, four thoracic vertebrae, one lumbar vertebra, a right talus, a right calcaneus, a left radius, right distal and left proximal femora, metacarpal, metatarsal, carpal, and tarsal bones. The well preserved cranium and pelvis

suggested a male individual 33 to 45 years old. The height of the man was estimated as 5ft 7 in (*ibid*). One lumbar vertebra showed osteoarthritis lipping. A curious fracture line was observed in the lower left occipital bone. This lesion had partially healed and was possibly the result of a blow to the left lamboid suture area which caused a split in the thinner bone at the cranial base.

#### Grave F780

This burial consisted of a male cranium, mandible, axis, atlas, and four cervical vertebrae. Teeth from the upper and lower jaws indicated an age of between 17 and 25 years. As with the individual from F214, the maxilla and mandible showed much alveolar resorption together with a calculus deposit on the teeth.

#### Grave F308

One individual was represented by ten post-cranial bones. The structure of the femur suggested an adult female. ■

### The early medieval pottery kilns

[Location plan Fig 172, p185; detail plans Fig 174, p187; pottery Fig 175, p188]

Seven, perhaps as many as nine, small, single-flue updraught pottery kilns were excavated. The locations of these are shown in Figures 144 and 172 and detailed plans of them are given in Figure 174. No kiln survived to the level of the floor of its firing chamber and two were so badly damaged that their identification as kilns is uncertain. Five of the kilns (F11, F12, F13, F349, & F354) each had a central tongue attached to the rear wall; not enough of the other kilns (F371, F495, F497, & F553) survived to make clear their internal arrangements. The largest kiln (F349) was the most intensely burnt of the group. Its central tongue had been rebuilt at least once. The kiln cut the stoke hole of F354 and may have been a replacement for it. Where a stratigraphic relationship could be established between a kiln and a robber trench, the kiln was found to be the earlier (ie the kilns F495, F497, & F553 were cut by the robber trenches F33 & F38).

### Summary of the pottery produced in the kilns

by C M Cunningham

The seven certain kilns produced a total of 86.535 kg of pottery (6,958 sherds). Of this 15.8% by weight came from F354, the earliest kiln, and 65.7% from the slightly later F349; the others yielded comparatively very little. The fabric and form numbers referred to are the standard classification for Essex (Cunningham forthcoming) and the percentages given, unless otherwise stated, are of total rim length.

With the exception of two sherds of Hedingham ware (Fabric 22), only one fabric was present. This belongs to the tradition of 'early medieval ware' (Fabric 13) and is a fairly low-fired coarseware with sand tempering. Some examples have limited and

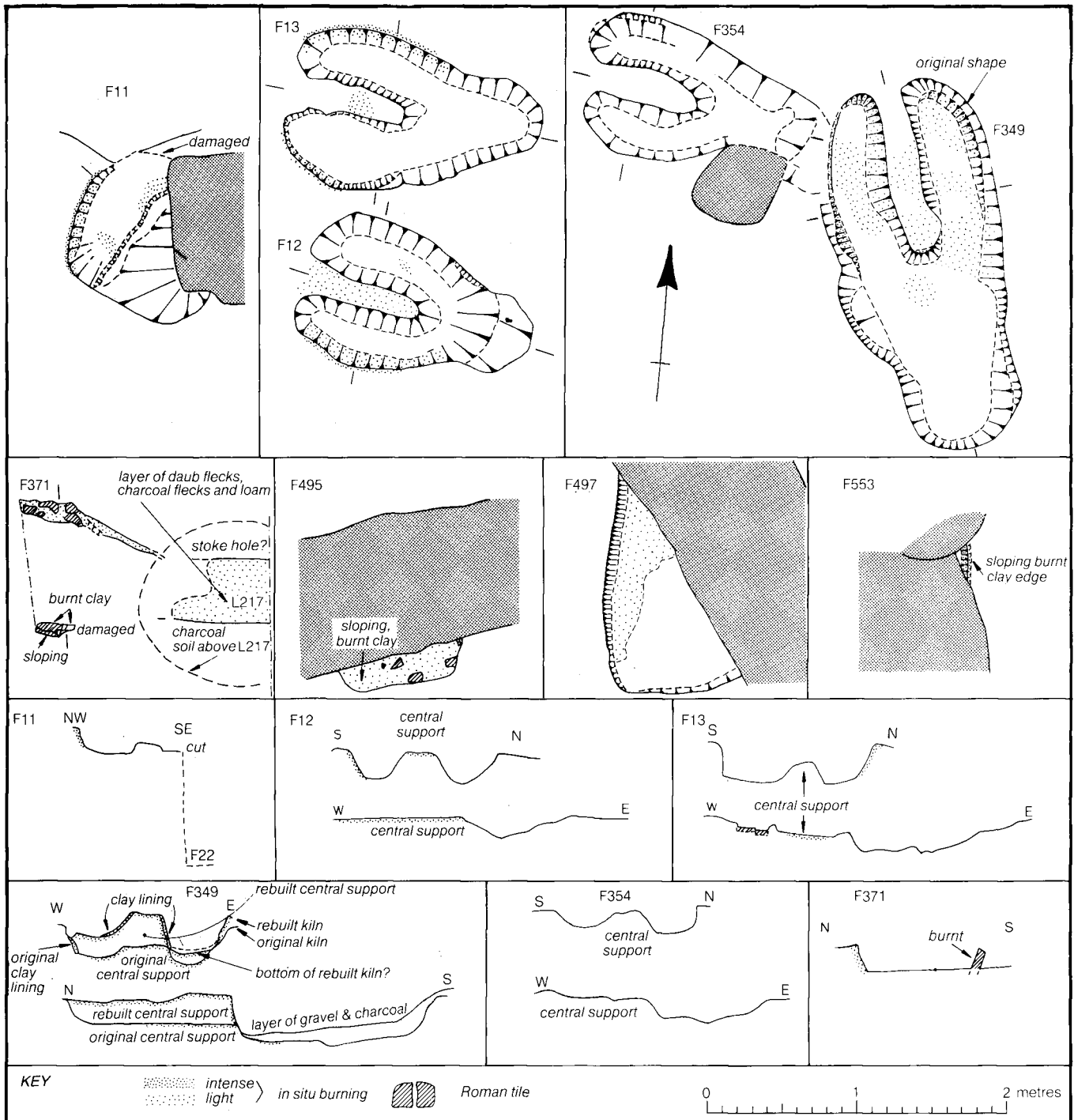


Fig 174 The early medieval pottery kilns. [Pages 186-9]

superficial inclusions of shell. The larger, thicker-walled vessels often have correspondingly coarser tempering. Firing conditions varied considerably, producing colours from light red to grey, often on the same vessel, although grey predominates. Obvious wasters were few, but overfiring was common.

The most common vessel form manufactured (78.5%) was the simple cooking pot with a sagging base, a fairly pronounced shoulder, and a short upright or slightly everted neck, usually with some thickening of the rim (Form C3). Rilling on the body was typical. Several rim variations were present, the most

frequent being externally thickened, with a flat top and a slight internal bead (Rim Form B2A, Fig 175.1). This form comprises over 50% of material from kilns F349 and F12, and just under 50% from F354. The thickening of this rim developed increasingly into an external flange (Rim Form C3, Fig 175.2), which is absent from F349 and best represented in F13. Next in importance was the more simple rim with a small pointed external bead (Rim Form C1, Fig 175.3), most common in F349. There was one example of a miniature cooking pot (Form C3B) with a plain, slightly thickened rim of early type (Rim Form B2, F349, Fig 175.4) and a single cavetto rim (Rim Form

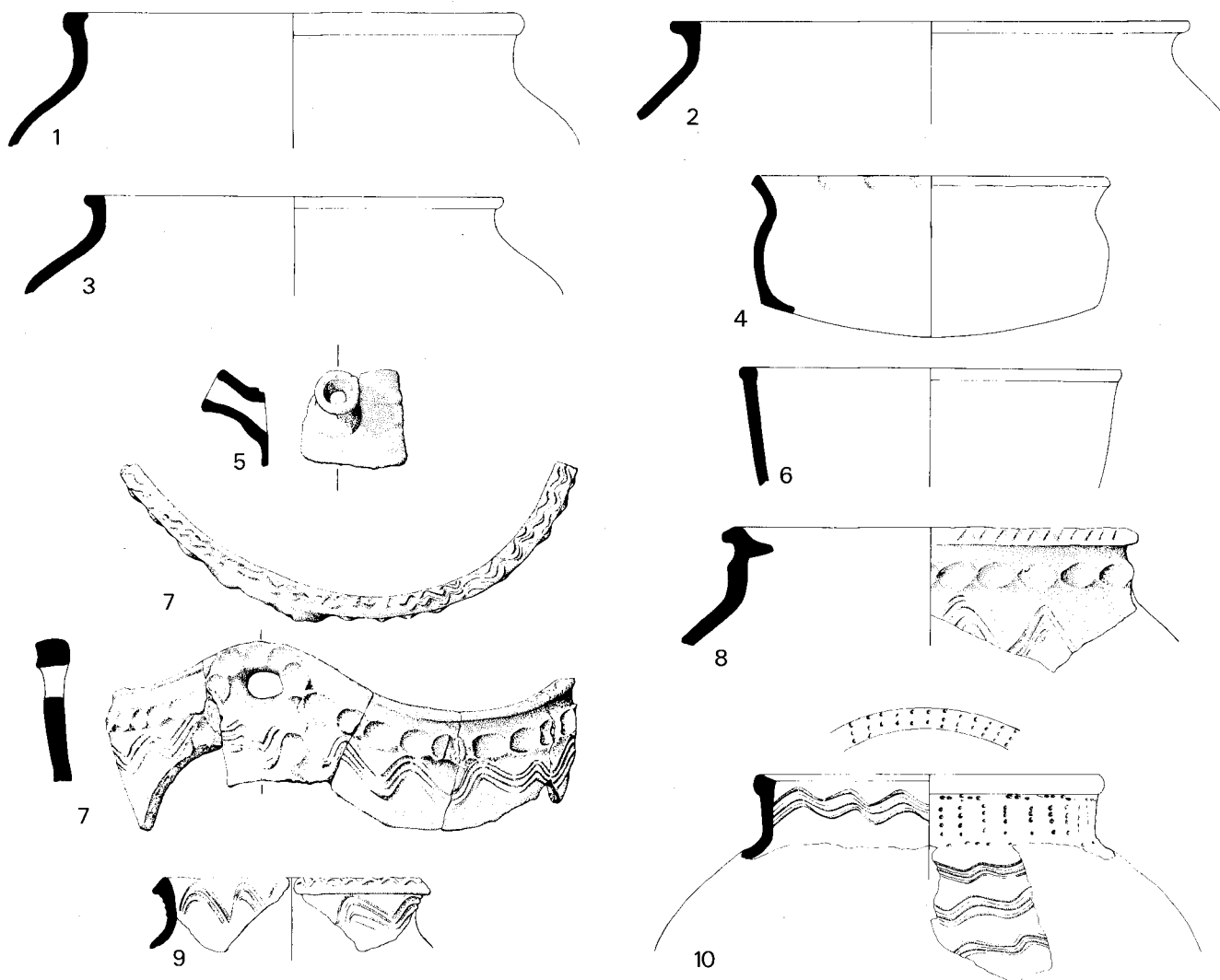


Fig 175 A selection of pottery from kilns. 1:4 [Pages 187-8]

D2, F11). It is not certain, however, that this last rim is a product of F11.

Spouted pitchers (Form C22, Fig 175.5) were created by adding a spout and handles to the cooking pot of Form C3. These comprise 1.5% of the total and survive only in Rim Form B2A.

The second most common vessel form (3.6%) is the bowl (Form B), normally apparently hand-made. This occurs with a simple, slightly thickened rim (Rim Form B2, F349, Fig 175.6) or with the more defined bead rim (Rim Form C1).

Minor vessel forms comprise a large decorated 'bucket' (Form C20, Fig 175.7) with a flat-topped thickened rim (Rim Form A2) above which pierced lug handles rise, fragments of decorated straight-sided storage jars (Form C21) with either plain thickened (Rim Forms B1 and B2) or bifid rims (Rim Form F1, Fig 175.8), pitchers with pouring lips and handles (Form D), and fragments possibly from curfews (Form X21).

Burnishing was the most common surface treatment, usually associated with the more simple rim forms. Combing regularly occurs, sometimes on the inside neck and the top of the rim, as well as on the external

body (Fig 175.9). This can be accompanied by thumb-applied strips and/or piercing (Fig 175.10). Finger-pressed rims are found most frequently on simple thickened or beaded rim cooking pots (3.6% of rims). A total of 15.2% of all sherds, and every vessel type represented, bore some decoration.

In the absence of supporting evidence, dating must rely mainly on typological comparison. Evidence from elsewhere in the town (*CAR 1*, 40) and the castle (Cunningham 1982) shows that developed rim forms are not present locally in groups dated to the 11th and the first half of the 12th centuries. The high proportion of decorated sherds and the presence of Hedingham ware (in production probably before c 1200) in kilns F349 and F354 suggest a date in the second half of the 12th century. The more developed of the rims probably belong to the early 13th century. Kiln F354, therefore, could have begun production at any time after the mid 12th century, whilst kiln F13, at least, suggests the continuation of pottery manufacture on the site into the early decades of the 13th century. Thus kiln F13 was broadly contemporary with the kilns at Mile End (Drury & Petchey 1975).

It is intended that the pottery produced in the Middleborough kilns will be fully published in a future volume of the *Colchester Archaeological Reports* devoted to the post-Roman pottery from the Colchester excavations of the 1970s. ■

### Building 74 (early medieval)

[Location plan Fig 172, p185; detail plan Fig 176, p189]

Building 74 (Figs 172 & 176) was associated with the early medieval pottery industry. It was a timber structure of uncertain plan and function. The remains consisted of postholes, stake holes and slots and contained early medieval pottery including products of the kilns. There were no floors attributable to the building but F464 (Fig 176), which was a group of Roman tile fragments over a small burnt patch of soil, may have been part of a hearth. Some of the postholes formed a straight line; these had been set in a trench which varied in depth from 0.25 m to 0.56 m (Fig 176). The remains were sealed by Building 75.

### The robber trenches (medieval)

[Plan Fig 172, p185]

Robbing activity (Fig 172) first occurred in the 12th century, presumably when the kilns were still in operation. The latest robbing took place perhaps as late as the 14th century to obtain materials for Building 75.

### Building 75 (14th to 19th centuries)

[Location plan Fig 144, p156]

The development of Building 75 (Fig 144) can be expressed in terms of four phases datable very broadly to the 14th, 15th, 16th, and 17th-19th centuries. Detailed study of the pottery will probably lead to a review of these dates. The walls of Phases 1 to 3 were timber-framed and set on surface-built, mortared plinths which were intended to keep the ground-plates free from damp. Phase 4 saw the replacement of the open hearths with inserted brick chimney-stacks and later the introduction of brick walls and floors of brick or timber. Preservation of the remains was poor, especially of the last phase which had been severely affected by features associated with the Cattle Market set out after the demolition of Building 75 in c 1862.

#### Phase 1 (14th century)

[Plan Fig 177, p190]

At first Building 75 was a rectangular block which consisted of a hall with a central hearth and a service room to the south (Fig 177). The hall may have been separated from the service room by a partition of some kind along the line later destroyed by the Phase 4 drain F114. The floors were daub and the position of the central hearth F281 was indicated by a small intensely burnt area without any superstructure. The service room had contained a sequence of at least three ovens. Not much survived of the first two (F392

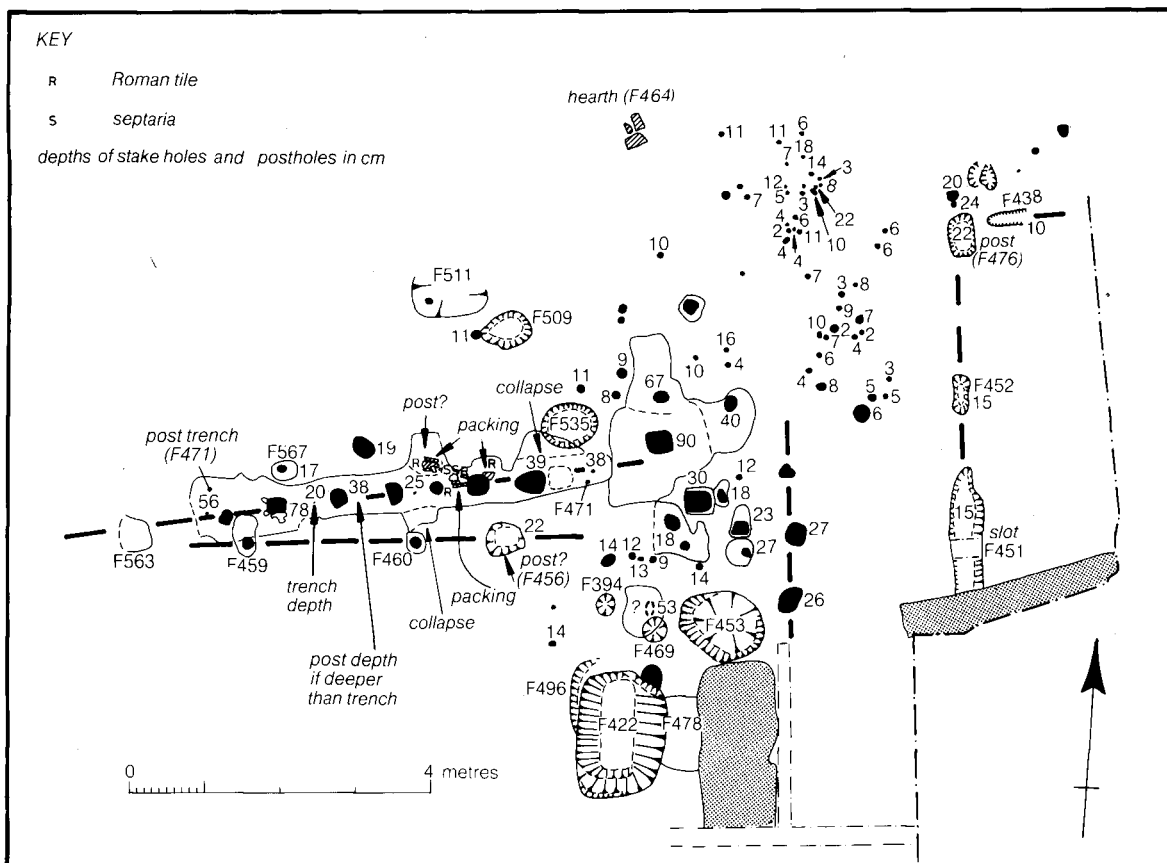


Fig 176 Building 74. [Page 189]

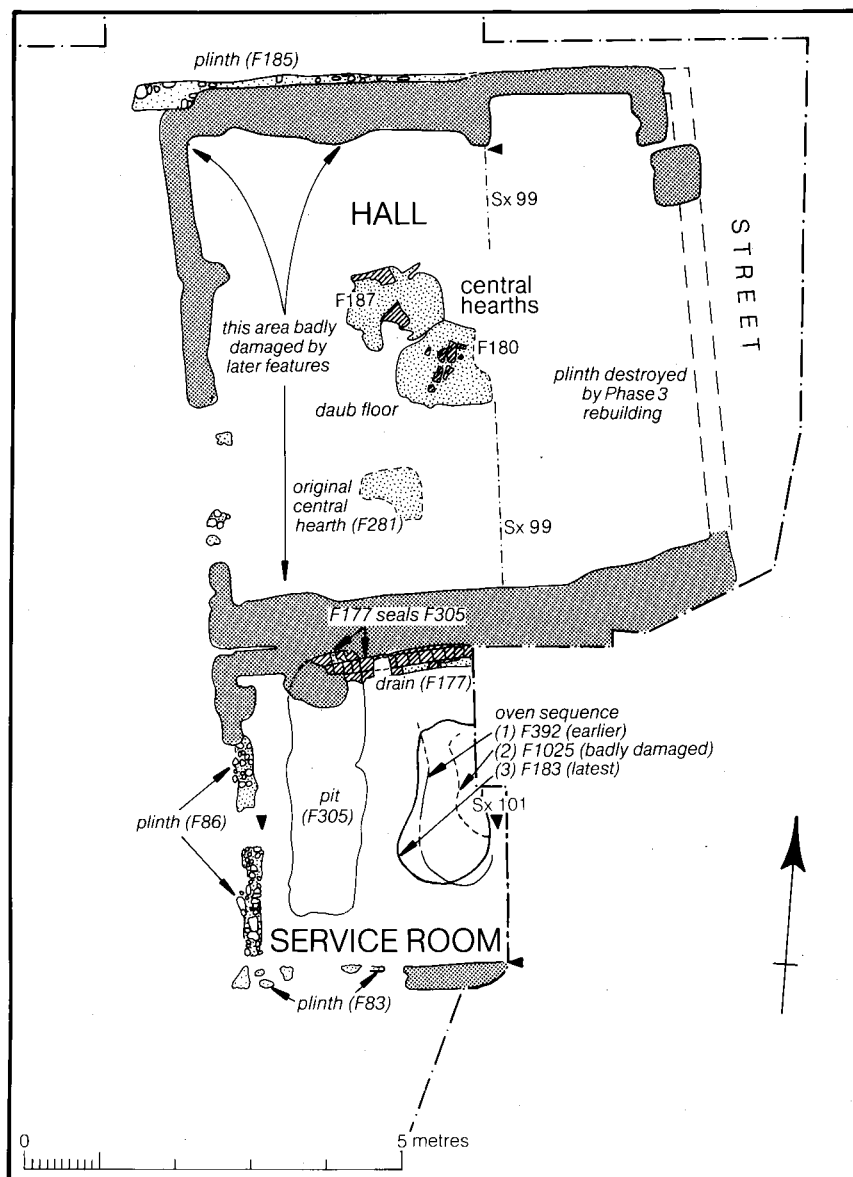


Fig 177 Building 75, Phase 1. [Pages 189-90]

& F1025) since they were mostly destroyed during the construction of the last oven (F183) although the group was clearly visible in section (Sx 99, Sheet 6b; Sx 101, microfiche). Later the hall was refloored and a new hearth (F187) built which was subsequently replaced or augmented by another similar hearth (F180) set out next to it (Figs 177-8). The fact that these two hearths were significantly further north than the first one (F281) suggests that the service room was not original but was an insertion contemporary with hearths F187 and F180. A drain built of peg-tiles (F177) sealed a long pit (F305) and probably post-dated the hearth F281.

### Phase 2 (15th century)

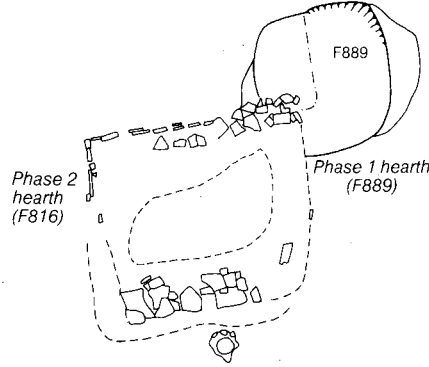
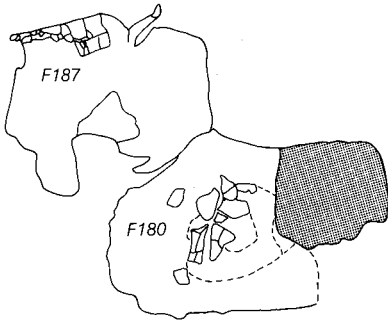
[Plan Fig 179, p192]

During Phase 2 the south end of the hall block was modified, a new central hearth (F161, Fig 178, p191) built, a north wing added, a large oven constructed, and a gravelled backyard laid out (Fig 179). The shell

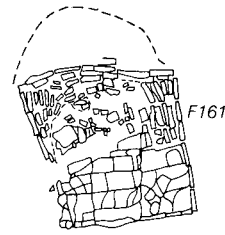
of the hall block in Phase 2 seems to have been essentially that of Phase 1. Internally the hall block was changed so that there was a new pair of service rooms and a cross-passage, the northern side of which presumably had been destroyed. As implied by the northerly position of the new central hearth, a hearth (F183, Fig 178, p191) was laid in the western service room and, like the new central hearth (F161), was neatly built of broken peg-tiles. The central hearth also contained a few fragments of brick. The Phase 1 drain (F177) continued in use. The north wing was built as two compartments each of which at some stage contained a square latrine pit (F87 & F437), built with walls of coursed, mortared rubble. The dates of construction of these features are difficult to establish because the objects in their backfill only indicate when the pits became redundant. The fill of F87 contained 16th- or 17th-century brick, pottery of similar date and a Nuremberg token of 1585-1640 and thus indicates that the pit was probably backfilled in the 17th century during the

Building 76, Phase 1 and 2: central hearths

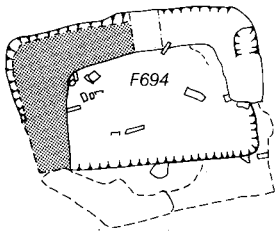
Building 75, Phase 1: central hearths



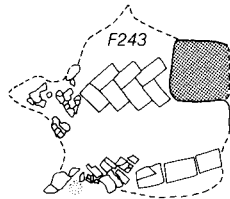
Building 75, Phase 2: central hearth



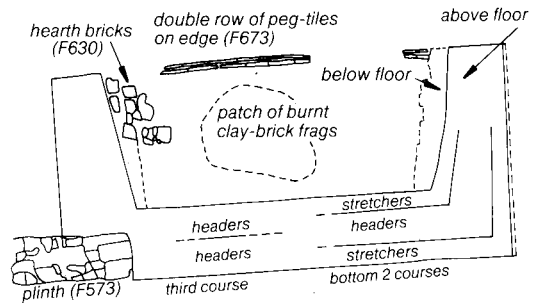
Building 76, Phase 3: central hearth rows of upright peg-tile robbed out



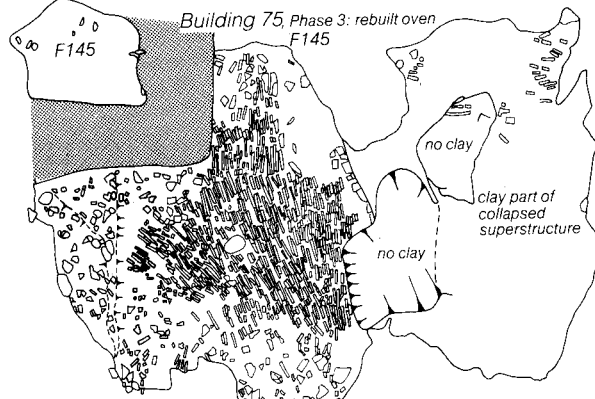
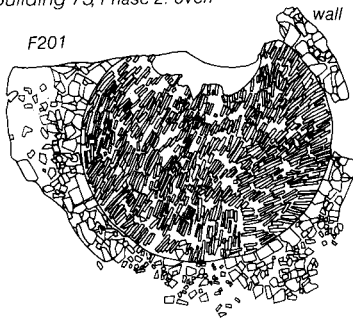
Building 75, Phase 3: central hearth



Building 76, Phase 4: inserted chimney-stack (F593)



Building 75, Phase 2: oven

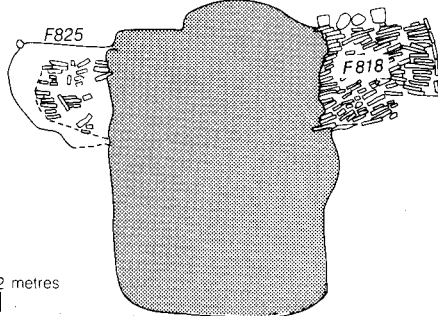


F145 seals F201

Building 75, Phase 2: hearth (against wall)



Building 76, Phase 3: hearths



Building 76, Phase 2: oven F487

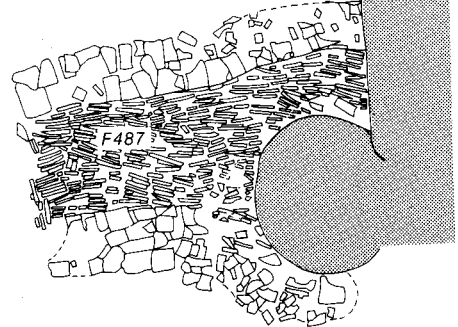


Fig 178 Ovens and hearths of Buildings 75 and 76. [Pages 189-202]



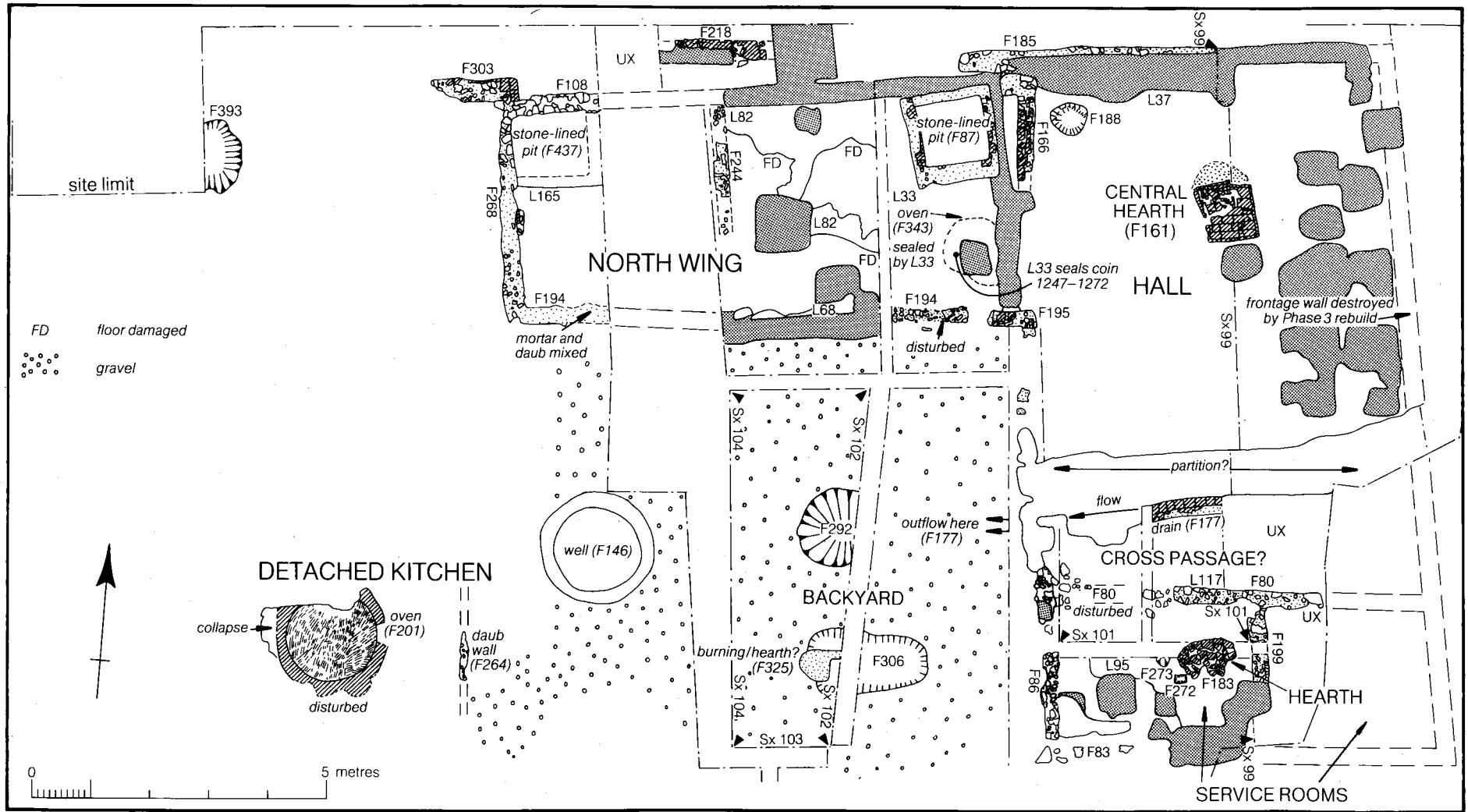


Fig 179 Building 75, Phase 2. [Pages 190 & 194]



first part of Phase 4. The absence of brick from the lining of F87 implies no more than it was unlikely to have been built after the 16th century. The walls of the other pit (F437) had been robbed and the remains sealed by the later daub floor of the north wing. Thus F437 probably was not in use as late as F87 and perhaps was replaced by it either in Phase 3 or late in Phase 2. The walls on the east side of F87 pointed to a complex sequence of structural changes. Several interpretations of the sequence are possible only one of which is presented here (Figs 179 & 180). The oven (F201, Fig 178, p191) was circular in plan and entirely built of peg-tiles, its base being flat and made of tiles set upright. To the east, part of a plinth (F264) was possibly all that was left of a detached kitchen in which the oven was placed.

### Phase 3 (16th century)

[Plan Fig 180, p193]

In Phase 3, the hall and eastern end of the north wing were rebuilt, a south wing was added, and new daub floors were laid throughout (Fig 180). The only Phase 2 structures which were retained were the screens (or cross) passage, the service rooms and the western half of the north wing.

The Phase 2 hall was replaced by one of smaller size, with a room to the north perhaps divided from the hall by a narrow cross-passage. A new hearth (F243, Fig 180), built of bricks in a herring-bone pattern, was laid so as to lie within the centre of the new hall. The plinth (F73) of the south wall of the new north room was built directly on top of the Phase 2 hearth (F161; Sx 99, Sheet 6b). Two very damaged fragments of mortared plinths (F102) lay just to the south of this wall. These were probably the remains of a wall forming the south side of a narrow east-west passage. If not, the fragments must have been dislodged from another wall, perhaps F73, some time after the demolition of the house. The drain (F177) was modified if not relaid in Phase 3. The stumps of the walls (F300 & F301) to the west may have formed an opening for the drain. The wall (F199) between the two service rooms to the south may have been demolished during this phase.

The south wing had two compartments both of which appeared to have had a hearth. In the west room, the hearth (F133) was a piece of a broken lava quern lower-stone set in the floor whereas in the east room

there was a surface of broken peg-tiles set upright (F130). This resembled the hearths of Phase 2 but showed no sign of having been burnt. A well (F146) was probably built about this time since in addition to septaria and peg-tile, some brick was contained within its circular wall, the face of which had then been plastered. The depth of the well was not established. The base of a wall (F263) to the south of the well suggested that the latter had been wholly or partly enclosed. This wall had no mortared plinth but was of daub plastered on the east side. To the north, the backyard was resurfaced and to the west the large oven (F201) was demolished and replaced by another of similar construction (F145, Fig 178, p191). Like its predecessor, it is not certain whether the oven was in a detached kitchen.

Later the north wall of the south wing (F274) was demolished and apparently replaced by a less substantial wall (F206) further south. The gravelled backyard was extended southwards to cover the remains of the demolished wall.

The make-up for the backyard of Phase 3 contained three fragments of stamped clay or daub probably from a fireback (*see report below*). If, as seems likely, these fragments derived from alterations to Building 75 then they may have been associated with one of the hearths of Phase 2.

### Stamped clay fireback fragments

by P J Drury

[Fig 181, p194]

The three fragments of burnt clay (Find Nos 766-8) are in a relatively friable, orange-red, very sandy fabric. The largest piece is about 55 mm square. All have one finished face, largely reduced grey, as are some broken edges, suggesting cracking in the presence of mildly reducing heat; maximum surviving thickness about 30 mm. The faces are impressed with two stamps (Fig 181 A, B). The first (two examples), a simple rosette, is clearly circular, whilst the effect of compressing the clay with the second, a lattice, has caused the survival of a reflection of its circular shape.

A similar fragment with a stamp smaller than, but not unlike, A has been published from Braintree (Drury 1976, fig 32.7) without identification. The lack of a surviving back face suggests that they are not derived

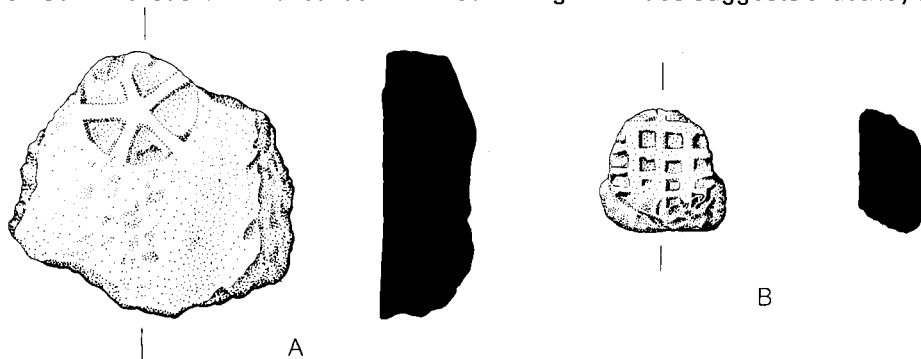


Fig 181 Fragments of stamped daub. 1:2. [Pages 194-5]

from tile-like objects, but from clay modelled and burnt *in situ*. The fact that some irregular broken edges of these examples are reduced, like the faces, suggests that the clay cracked in course of usage. Both features are consistent with their being derived from firebacks formed *in situ*, probably against some form of timber and clay wall. Thus they are concomitant with the use of clay and timber chimneys, evidenced elsewhere by chimney copings (p202) and Class 1 louvers (Appendix 4, pp211-3). The decoration finds a parallel in the use of tile stamps to decorate freestanding 17th-century firebacks in North Devon (Keen 1969, 151-2). These examples are, however, best dated by their context. They were found in the make up for the metalled yard of Building 75, Phase 3, deposited in the 16th century. They presumably derive, therefore, from a late medieval predecessor. ■

#### Phase 4 (17th to mid 19th century)

[Plan Fig 182, p196]

At the beginning of Phase 4, a brick chimney-stack was inserted against the north wall of the main block and probably another built in the screens passage, against the north side of it (Fig 182). The position of the northern chimney-stack implies the demolition of the wall between the hall and the north room in the main block of Phase 3 and the position of the other stack indicates the demolition of all surviving internal Phase 2 and 3 walls south of the north side of the screens passage. The base of the northern chimney-stack (F68) was well preserved and contained a later ash box sunk into the floor and lined with broken brick. Much less survived of the second chimney-stack (F79). Here a projection pointing southwards showed that there had been a hearth on the south side. Since so little survived, the stack could have been of the common H-shape with hearths to the north and south. If this had been the case, then there would have been at least one partition between the two chimney-stacks since otherwise they would have heated the same room. The ?stack F79 was later altered with the effect that it sealed the drain F114 which, by this time, had been rebuilt in brick. Two patches of brick (F78 & F335) may have been part of the rebuilt drain whereas two others (F99 & F275) were the remains of small brick-lined pits, the purpose of which is obscure.

Later a brick floor was laid in the north wing but, by the time of the excavation, little was still *in situ*. Elsewhere no substantial floors of this period were found. Initially the Phase 3 daub floors must have been retained until they were presumably replaced in timber. A brick-lined soakaway (F157) was built against the north wall of the north wing probably in the 18th century. Most important, this cut the south wall of Building 76 indicating that its south wing had been demolished by this time. Possibly contemporary with the construction of the soakaway was the addition of a brick-built room or passage on the north side of the north wing. This had two brick floors on different levels. The lowest (F105) was the earliest

whilst the latest sealed the pit F157 (Fig 182). In various parts of the house, six pots of c 1650-1725 were set into the floors exactly so that their rims were at ground-level (Appendix 8, microfiche). These were F104, F112, F140, F242, F271, and F441. A token dated to c 1660 lay near the top of the fill of pot F104. Pot F112 was buried either at the same time as the construction of the brick floor F105 and the pit F157 or shortly afterwards. Like pot F441, it was earlier than the brick floor F106.

The latest alterations to the building were as follows. Part of the south wall of the house near the street frontage was repaired or rebuilt in brick (F83 east). The east end of the drain was diverted northwards and the frontage wall, where it was affected by this modification, was repaired in brick. The well was no longer required and was capped over in brick probably c 1862. A soft-water tank (F257) was built outside the east wall of the building and a brick soakaway or cellar (F266) was constructed to the west of the north wing. The latter incorporated an earlier wall of a similar structure and sealed a coin of 1831-7. A brick drain (F270) led to F266. Two patches of brick (F433 & F434) are of uncertain function. A trench (F162), filled with clay and fragments of peg-tile, had been dug through the remains of the Phase 3 oven (F145). This may have been a wall foundation.

### Summary of the development of Building 75

[Fig 183, p197, & Fig 184, p198]

By analogy with surviving timber-framed houses elsewhere, it is possible to speculate about the nature of the superstructure of the building during each of its four phases. The most likely reconstructions can be summarised as shown in Figures 183-4 and described as follows.

In Phase 1, Building 75 consisted of an open hall with a service area to the south. It is not clear whether the service area would have been the ground floor of a two storeyed cross-wing or one end of the open hall. The latter is the more likely since, as described above, there is evidence which suggests that initially Building 75 consisted of only one large compartment. In Phase 2, Building 75 took the form of an open hall with a two-storeyed cross-wing to the south divided on the ground floor into a service room and a screens passage. In Phase 3, the open hall was demolished and replaced with an open hall of smaller size with a two-storey, jettied cross-wing on the north side. In Phase 4, brick chimney-stacks were inserted into the building and the central hearth with its (?)hood and timber-and-daub chimney (p30) were removed. In Phase 4, the open hall of Phase 3 would have been altered in one of three ways, all of which seem equally likely. These are:

- i) a floor was inserted into the Phase 3 hall
- ii) the Phase 3 hall was demolished and replaced with a two-storeyed structure which was the same height as the two cross-wings or

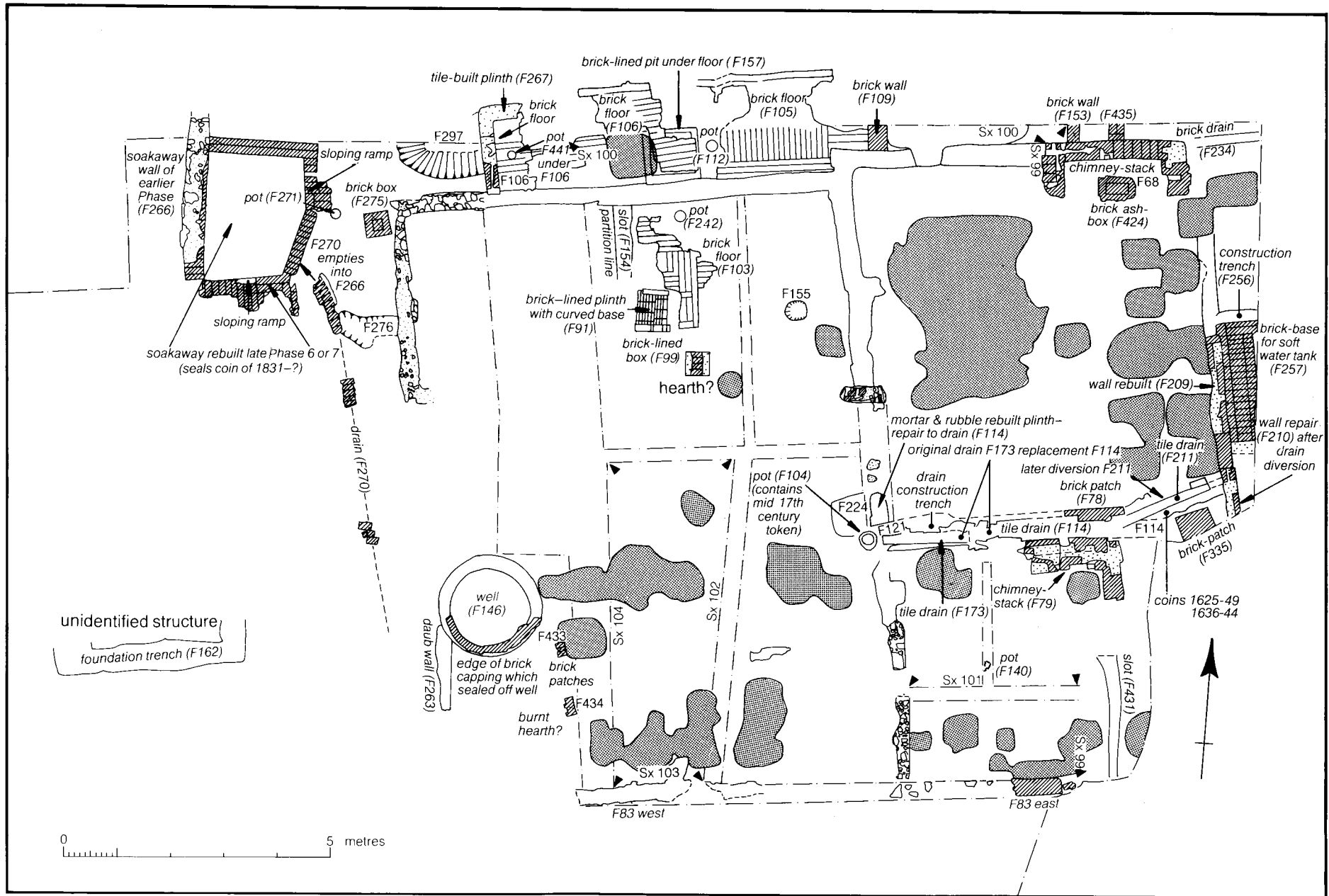


Fig 182 Building 75, Phase 4. [Page 195]

- C ..... chimney-stack
- H ..... hearth
- SA ..... soakaway
- L ..... latrine
- D ..... doorway
- SWT ..... soft water tank
- ..... surviving wall of previous phase
- ..... wall of illustrated phase

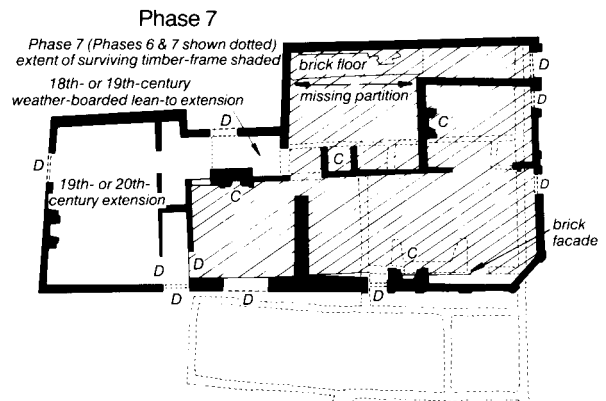
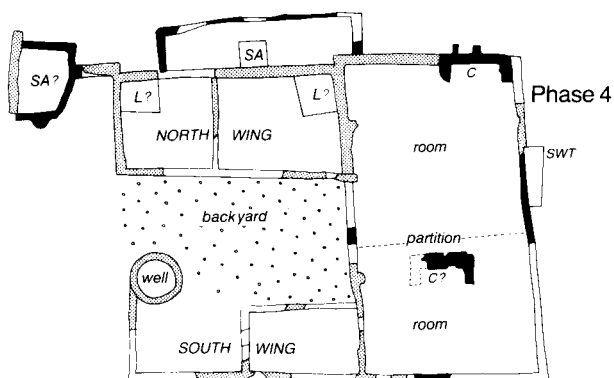
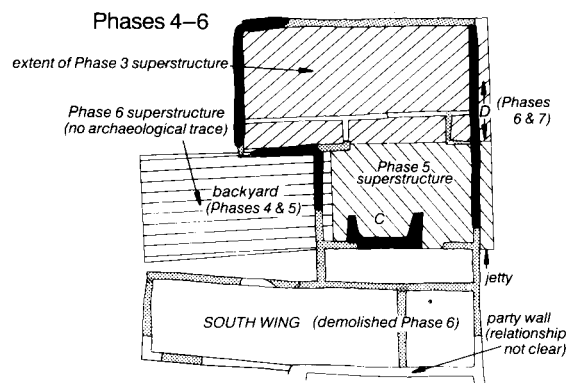
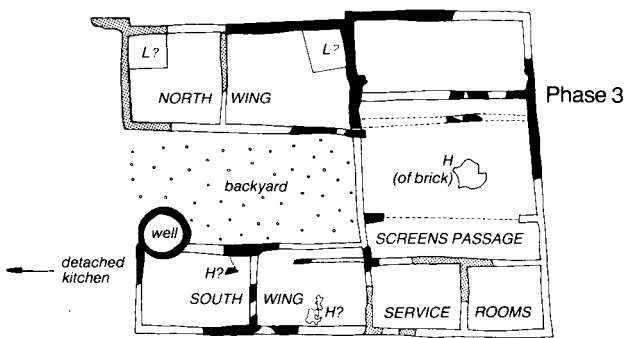
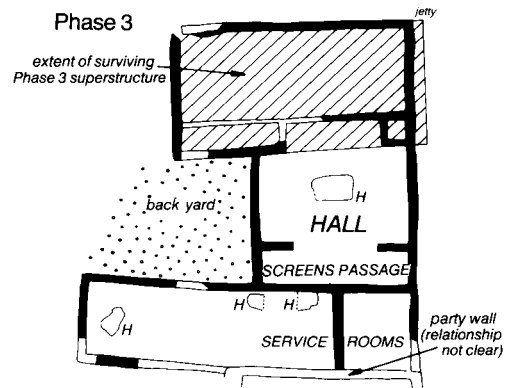
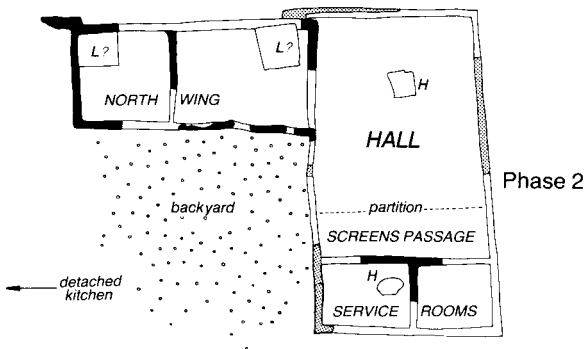
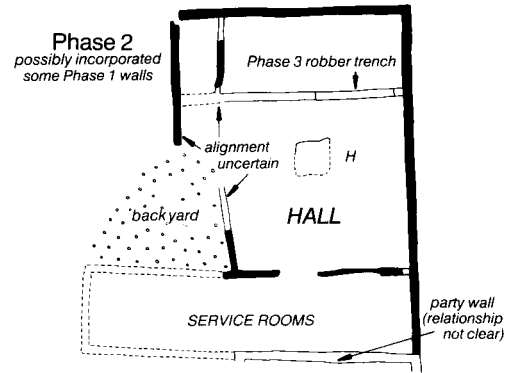
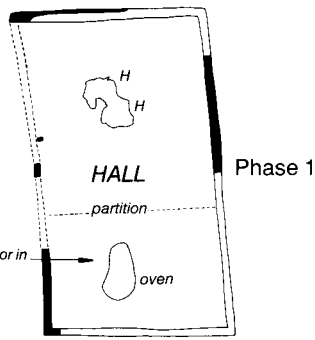


Fig 183 Development of Buildings 75 (left) and 76 (right) – plans. [Pages 195, 198, & 208]

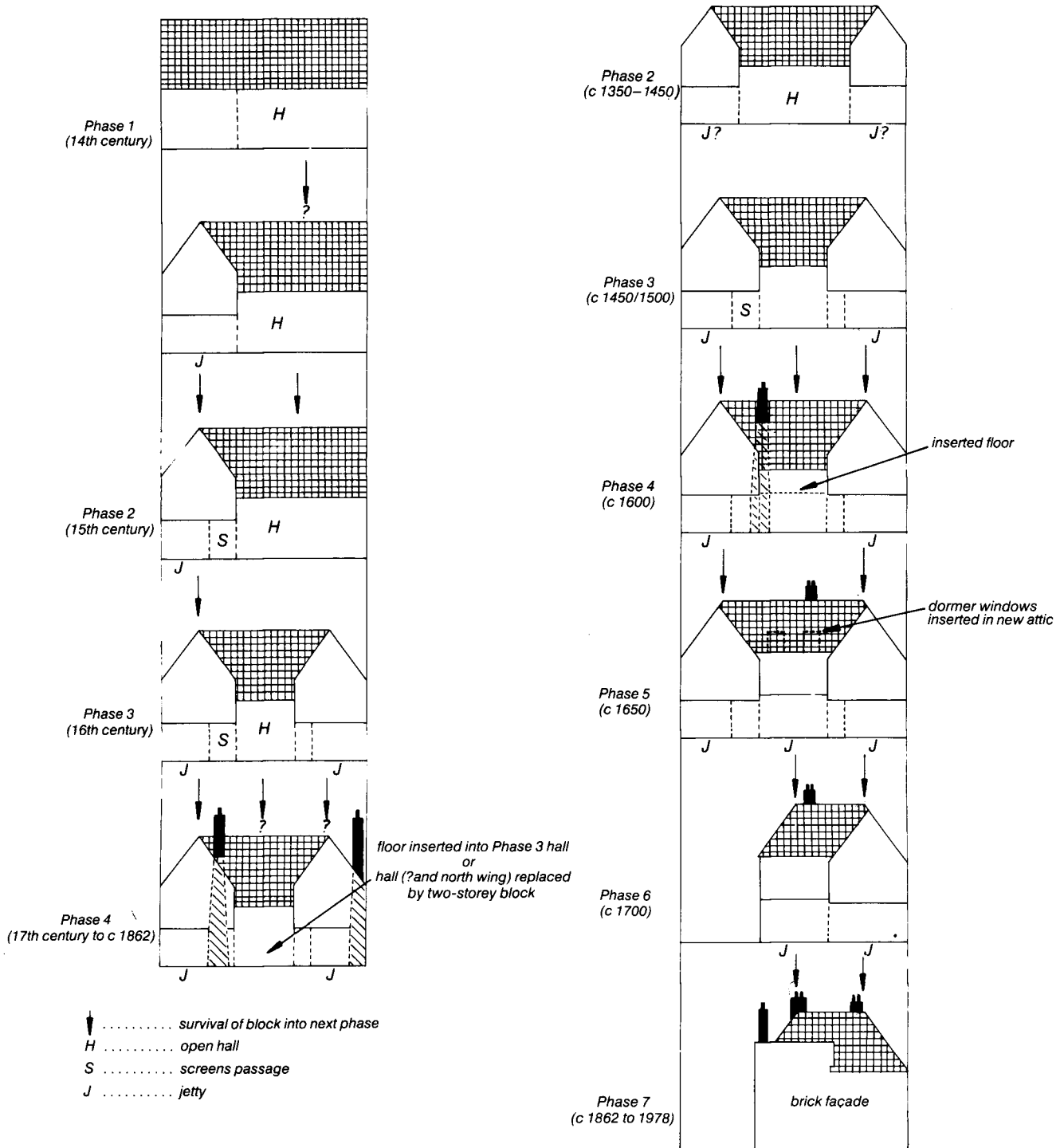


Fig 184 The conjectural development of Buildings 75 (left) and 76 (right) – eastern elevations. [Pages 195, 197, & 208]

iii) the Phase 3 open hall was partly rebuilt so that its roof could be replaced at a higher level and a floor could be inserted at first-floor level.

If Building 75 had survived and if its first cross-wing belonged to Phase 2, then it would have been similar to Building 76 and would have been typical of the oldest timber-framed houses found in Colchester today, ie 15th-century jettied cross-wings with altered or rebuilt halls of 16th- or 17th-century date.

### Building 76 (14th century to 1978)

[Location plan Fig 144, p156]

In the area later occupied by Building 76, the earliest activity after the robbing of the Roman foundations of Building 73 is represented by a series of pits, postholes and trenches (Fig 185, p 199), the purposes of which are unknown.

**Phase 1 (14th century)**

[Plan Fig 185, p199]

In Phase 1 (Fig 185), a structure was built which contained several postholes and a hearth (F889, Fig 178, p191), the presence of which was indicated by a burnt patch of daub. South of the hearth was a pot (F830, Appendix 8, microfiche) set in the ground so that its rim (now missing) was flush with the contemporary ground level. The pot was sealed by a layer of very broken-up daub associated with the hearth.

The plan of the building is obscure. Some of the mortared plinths of later phases were surface-built and it is evident from Sections 105-12 (microfiche) that the walls here assigned to Phase 2 could have originated in Phase 1 thus filling out our plan of the building in its earliest form. However, against this interpretation is the fact that, in this event, the Phase

1 hearth (F889) would not have been in the centre of the hall.

**Phase 2 (c 1350/1450 to c 1450/1500)**

[Plan Fig 186, p200]

Compared with Building 75, the remains of this and later phases were well preserved. In Phase 2, the building consisted of an approximately square hall with a room to the north and a long narrow room to the south which extended further west than the hall (Fig 186). Daub floors were laid throughout the building; the floor in the hall contained a coin of 1280-1350. The walls were built on mortared plinths made of reused Roman building materials with some peg-tile. The position of the west wall of the hall was not clear but was perhaps represented by an otherwise anomalous plinth (F813) built of peg-tile bonded with daub. In the centre of the hall was a hearth (F816, Fig

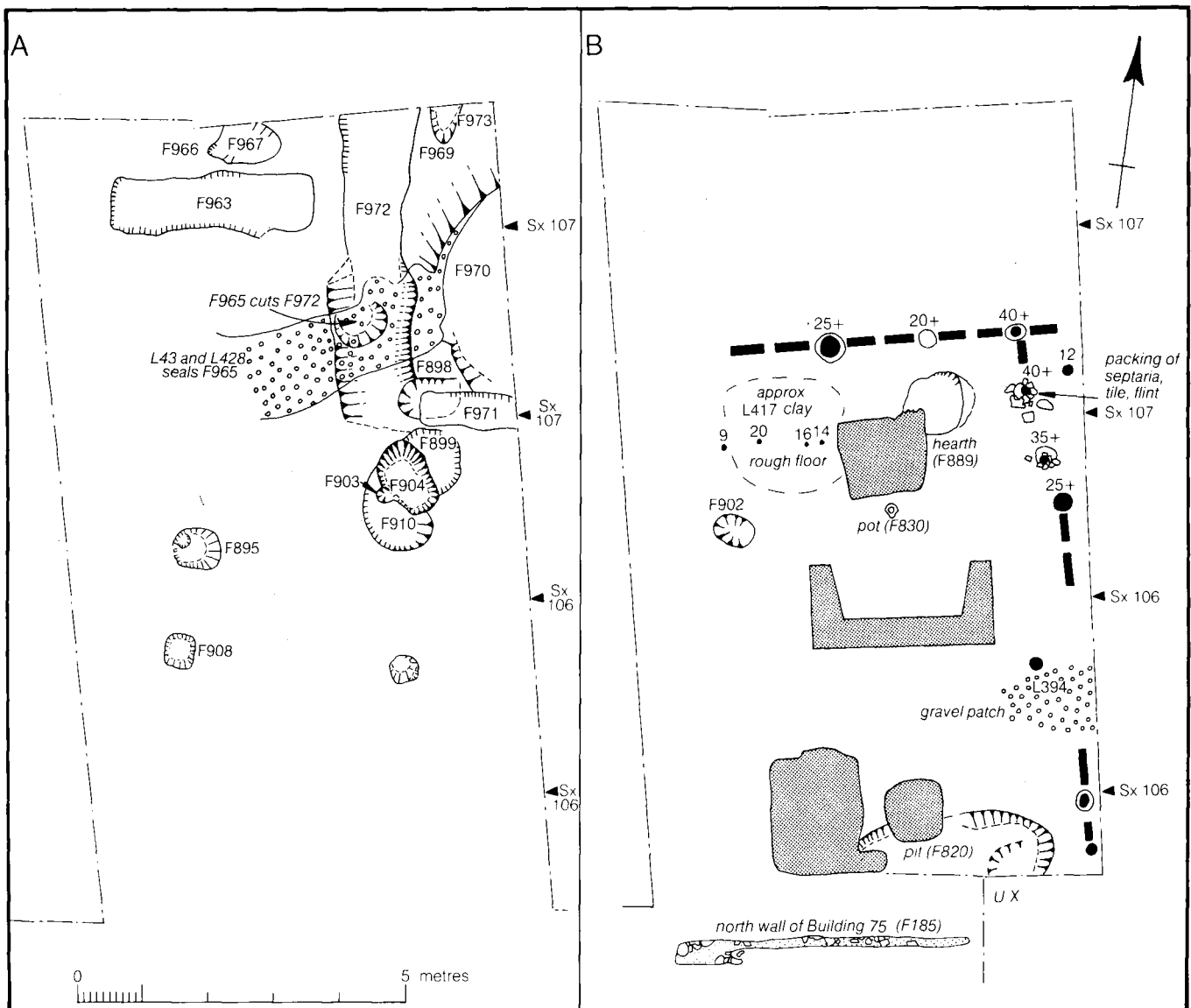


Fig 185 Building 76, pre-Phase 1 (left) and Phase 1 (right). [Pages 198-9]



178, p191). The remains of this consisted of a heavily burnt area bounded on the north, west and perhaps east sides by a double row of peg-tiles set on edge. Along the south side were some broken peg-tiles laid flat as if to form part of a *eredos* (Wood 1965, 259) perhaps connected to a hood and chimney overhead (p30). On the east side of the hall were some stake holes (Sx 110, microfiche) and on its north side the plinth had been robbed during the construction of the Phase 3 house (Sx 107, microfiche). The service rooms to the south contained an oven (F487, Fig 178) built of peg-tile laid flat for the walls and set on edge for the floor. The south wall of this room was shared with Building 75 whilst its north wall originally seemed to have consisted of two *speres*. The gap between the *speres* had presumably been blocked by a portable screen until a light wall (F820) was built. Fragments of an early medieval chimney coping were used as building rubble in a plinth (F573) of Phase 3. If the coping derived from the roof of the Phase 2 structure as seems possible in view of the context, it

must presumably itself have been reused from an earlier building because of its early date (*see report below*).

### Phase 3 (c 1450/1500 to c 1600)

[Plan Fig 187, p201]

The Phase 2 building appears to have been completely demolished and replaced with an entirely new building in Phase 3 (Fig 187). This had neatly made plinths of broken peg-tiles set flat in mortar with no reused Roman building materials. On the street frontage, the new plinth of Phase 3 directly overlay that of Phase 2. In plan, Building 76 consisted of a hall with north and south wings, the latter having two, possibly three, rooms. The hall was separated from the south wing by a screens passage, the positions of the *speres* (F573) being clearly indicated by their well preserved plinths. To the west was a gravelled backyard which may have been laid out in Phase 2. Building 76 contained four hearths. That in

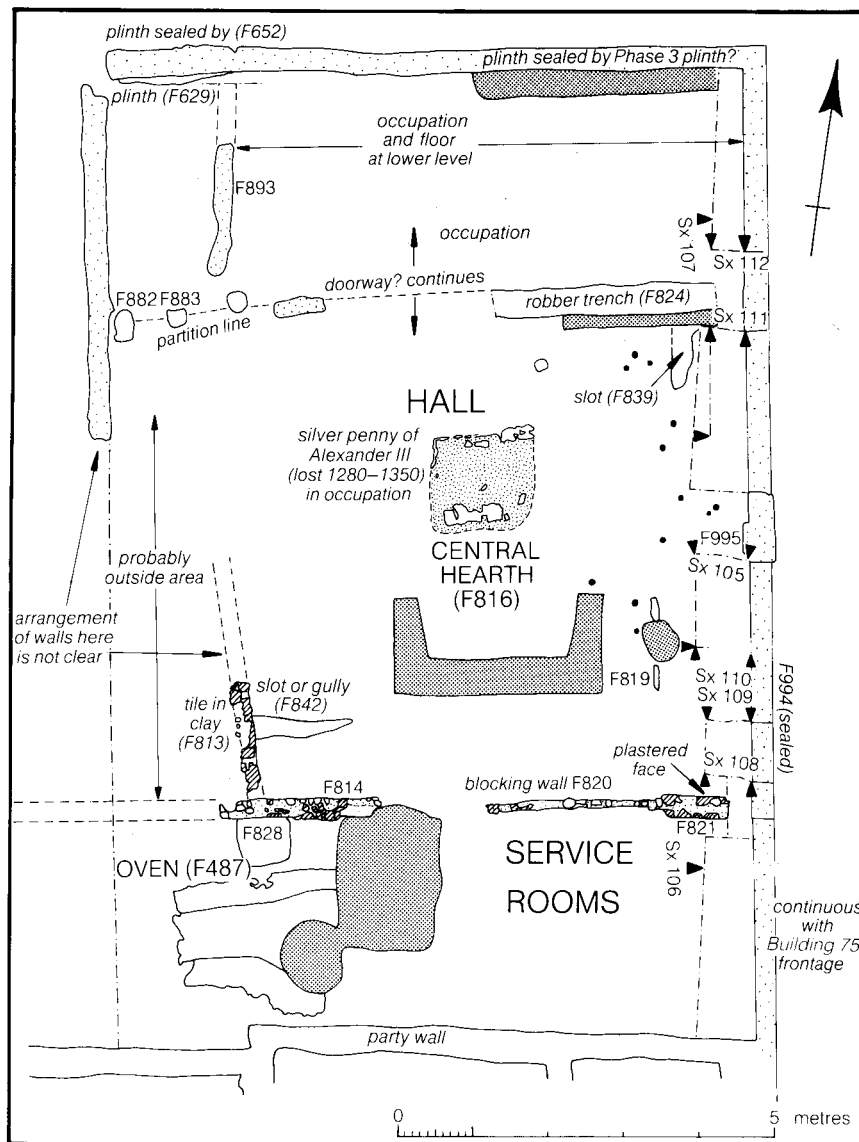


Fig 186 Building 76, Phase 2. [Pages 199-200]

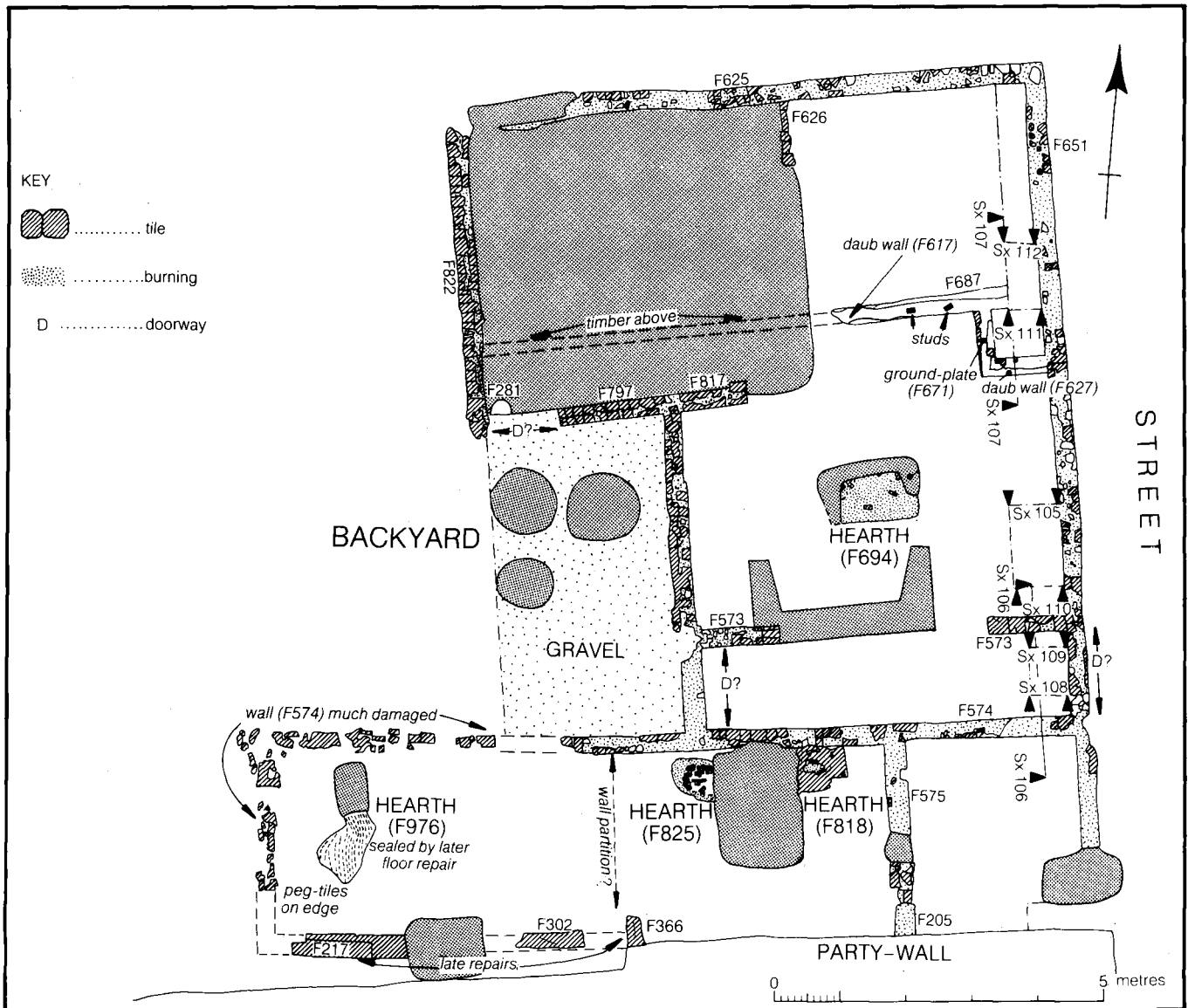


Fig 187 Building 76, Phase 3. [Pages 200-2]

the hall (F694, Fig 178, p 191) was centrally placed and consisted of an approximately rectangular mass of well mixed peg-tile and daub heavily burnt *in situ*. The other hearths (F818 & F825, Fig 178, p 191; F976) were in the south wing and were all made of peg-tile set on edge.

Much of the timber-frame of the Phase 3 north wing survived until the building was demolished in 1978. This and other parts of the extant superstructure are described below. Although almost all the timbers forming the ground floor of the north wing had been removed during the various alterations made to the building, the stumps of the internal walls on its east side were still in place and were uncovered during the excavation. The top of the mortar plinth of the south wall of the north room (F687) stood about 50mm above contemporary floor level and carried a daub wall (F617) the base of which survived to a further height of 70 mm. At regular intervals along this wall were the decayed remains of some studs which had been morticed into a timber ground-plate resting on

the plinth. The ground-plate had rotted and become compressed into a 10mm thick layer of decayed wood. The north face of the wall was plastered and painted white. No trace was found of any wattles between the studs. At the north-east corner of the hall and under the south side of the first-floor of the north cross-wing, the plinth F687 formed a box-like structure which was an integral part of the original Phase 3 plan. On top of the plinth on the south side of the 'box' was the base of a wall (F627) very similar to that over the plinth F687 whilst resting on the plinth on the west side were the decayed remains of a timber ground-plate (F671) which contained no traces of any daubed studwork as elsewhere. Hints of a north return at the east end of the plinth F817 indicate that there was probably a similar arrangement at the north-west corner of the hall.

Later a small pit (F791) was dug inside the box on the north-east side (Sx 107, microfiche). Also a new daub floor was laid in the south wing and minor repairs were made to the south wall.

## The chimney coping

by P J Drury

[Fig 188, p202]

There are four fragments (two joining) in a coarse sandy fabric with a grey core and reddish brown surfaces; all in part are smoke-stained (Fig 188). The thickened flat base has an incised pattern, probably to form a key. Parts of two apparently keyhole-shaped openings in the lower part of the wall survive; these were probably opposed. Diameter about 0.60 m; height 0.2 m. The fragments predate Phase 3 of Building 76 because they had been used as building rubble in the Phase 3 plinth F573.

Open cylindrical chimneys are known in stone from the mid 12th to the end of the 13th centuries; by the first quarter of the 14th century polygonal shafts were normal (Wood 1965, 282-4). The simple 'thistle' shape of this coping is closely paralleled in one of the earliest English examples, on the hall at Christchurch Castle, Hampshire, of c 1160 (*ibid*, pl 3A); and in the slightly more elaborate example from 79 High Street, Southampton, of c 1200 (*ibid*, pl 44A). Circular ventilation holes in the sides, though usually associated with chimneys with conical caps, also appear near the top of early open shafts, for example at Skenfrith, Monmouthshire, in the second quarter of the 13th century (*ibid*, fig 82).

Fragments of similar objects (wrongly identified as kiln furniture) were found at the kiln site at Mile End, Colchester, in production from the end of the 12th century until at least the middle of the 13th. One (Drury & Petchey 1975, fig 11.66), was wedge-shaped in section like the Middleborough example; the other (*ibid*, fig 11.65) was thinner, with a slightly thickened base. They are in a fabric very similar to the Middleborough coping, and it seems probable that it too was made at Mile End. Certainly the fabric belongs to the 12th or 13th centuries rather than

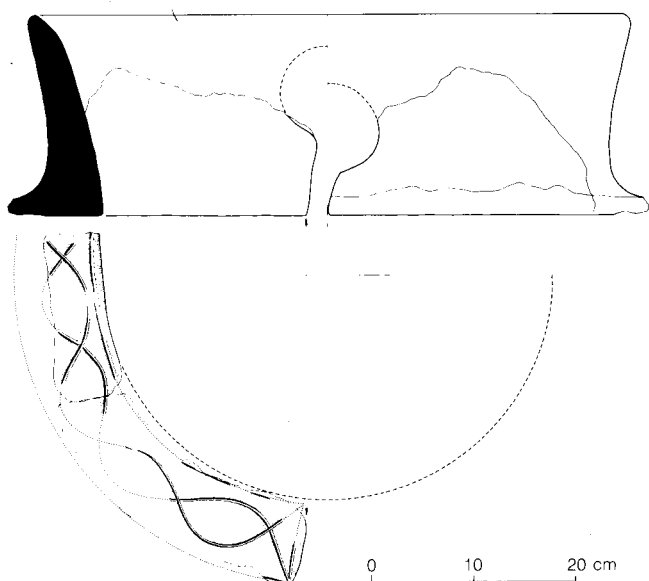


Fig 188 Fragments of a chimney coping. [Page 202]

later. Significantly, the Mile End kilns also produced small chimney-pots of a distinctive Essex type, related to the larger Sussex series (Dunning in *ibid*, 50-2).

The use of a ceramic coping on an ashlar chimney-shaft is perhaps unlikely, but it could have surmounted one of plastered rubble-work. Equally, and perhaps more likely, it could have capped a shaft of plaster or daub on a wattle-and-timber frame, perhaps over a smoke-bay rather than a true chimney. Medieval examples of such chimneys are documented (Wood 1965, 289; Salzman 1967, 99-100) and John Walker distinguished them from brick examples by colouring them yellow rather than red on his 1591 map of Moulsham (Essex Record Office, D/DM P2; Drury forthcoming b). Examples survived in use into the present century in the more remote parts of Britain (eg Beaton & Moran 1977; Brunskill 1962, 64, 73, fig 3). Differential staining on the outside suggests that the coping was bedded or flounced up to the base of the circular parts of the side openings; these would then serve to anchor the object more securely to the chimney, whatever its material. ■

## Phase 4 (c 1600 to c 1650)

[Plan Fig 189, p203]

The beginning of Phase 4 (Fig 189) is marked in the hall by the removal of the central hearth with its (?)hood and wattle-and-daub chimney and by the building of a brick chimney-stack (F593, Fig 178, p191) and a floor inserted at first-floor level. The chimney-stack was built against the north side of the screens passage slightly off centre so that the top passed to the west of the ridge of the roof. Two postholes, perhaps for temporary supports during building work, were dug at the north end of the hall and were sealed by a new daub floor. This was laid in the north wing and in the hall where it sealed the central hearth of Phase 3 (F694)

Later some small holes were dug along the east side of the hall block. These reflect the position of the Phase 2 stake holes and must also have been associated with activity within the hall block itself. A brick hearth (F630) was laid at the base of the chimney-stack, possibly as a secondary addition. This was bounded on the north side by a double row of peg-tiles (F673) set on edge and reminiscent of the treatment of the preceding Phase 3 open hearth (F694).

## Phases 5 and 6 (c 1650 to c 1862)

[Plan Fig 189, p203]

Phases 5 and 6 (Fig 189) were periods of substantial structural changes only detectable in the surviving timber-frame of the house. Phase 5 saw the demolition of the Phase 4 chimney-stack and the Phase 3 hall (now with an inserted floor) and their replacement by a new block of three storeys which extended as far south as the Phase 3 spere and the south side of the Phase 4 chimney-stack (F593). The

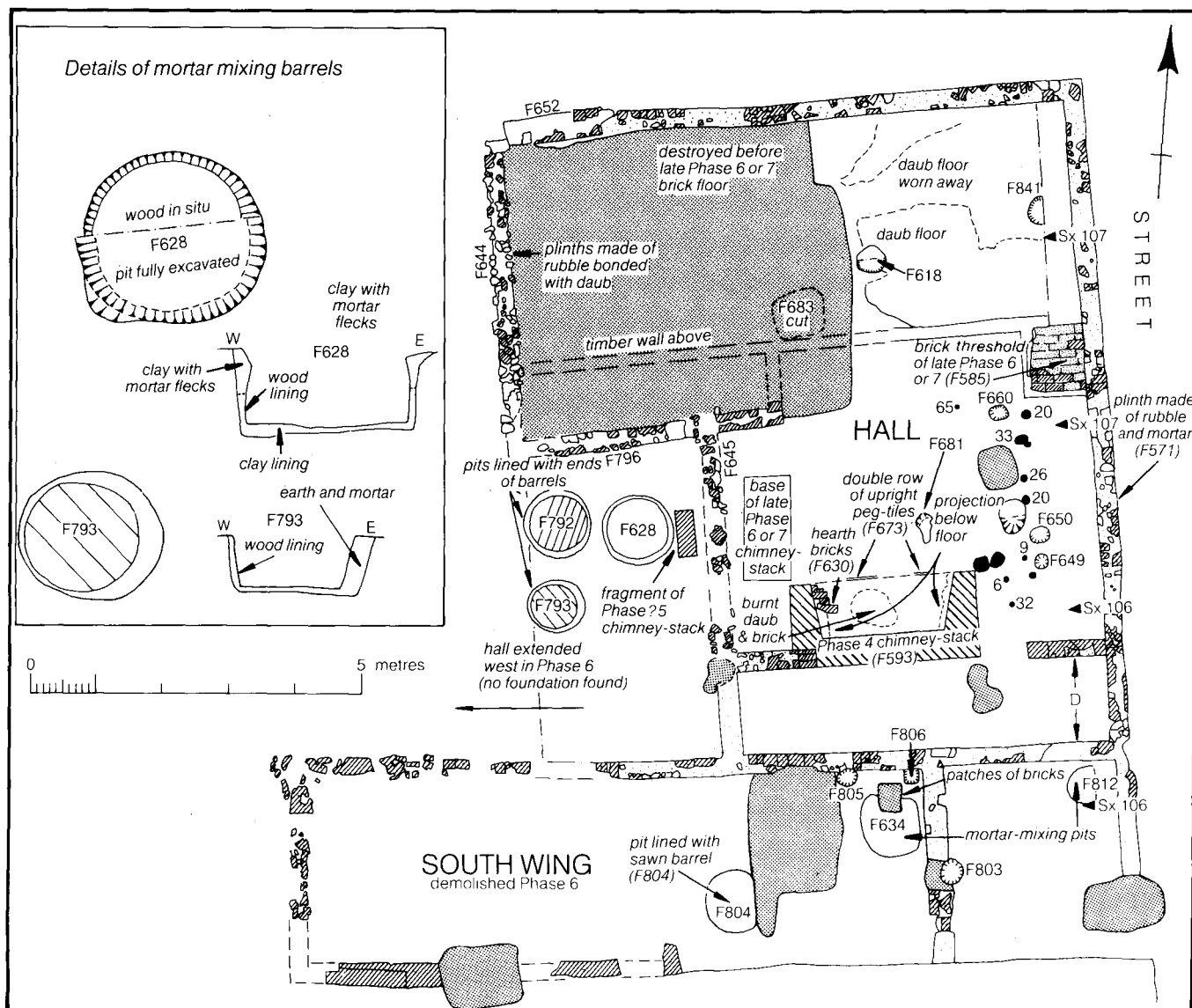


Fig 189 Building 76, Phases 4 to 6. [Pages 202-5]

new west wall lay 0.6 m to the east of the wall it replaced. In Phase 6, another three-storeyed block was built, this time to the west of the rebuilt hall block and over the backyard. Curiously no traces below ground level were detected of this structure or the west wall of the Phase 5 hall block apart from a few bricks which appeared to be all that was left of the base of a chimney-stack built on the east side of the Phase 6 block.

In the backyard of Phase 4, the ends of three wooden barrels were set in pits (F628, F792 & F793) and used for mixing mortar or plaster. They were filled with soft, powdery mortar and the shapes of the planks of the barrels were clearly discernible as bands of decayed wood highlighted by the white mortar (Fig 189). Three more pits, also used for mixing mortar or plaster, were in the south wing. Of these, pit F804 had contained the end of a barrel although the timbers were not so clear as in those in the backyard. The other two (F634 & F812) seemed not to have been timber-lined although they were filled with the same type of material as the others. Although probably of

17th-century date the precise relationship of these pits to the phases of Building 76 is not clear. Presumably the pits in the backyard predated the construction of the Phase 6 block whereas those south of it post-dated the demolition of the south wing making it unlikely that both groups were contemporary. The pits were probably used more than once especially those carefully lined with sawn barrels and, in view of their number, many batches of mortar or plaster were probably produced. The quantities involved must have been greatly in excess of what would have been needed during the various structural changes made to the house so that the pits must have been associated with the trade of the occupants of the house.

Late in Period 6, a brick surface (F585) was laid over the Phase 3 'box' at the east end of the house (Sx 107, microfiche). This was probably the threshold for a door which was inserted into the east wall and was perhaps associated with a division of the house into two properties along the line of the south wall of the cross-wing.

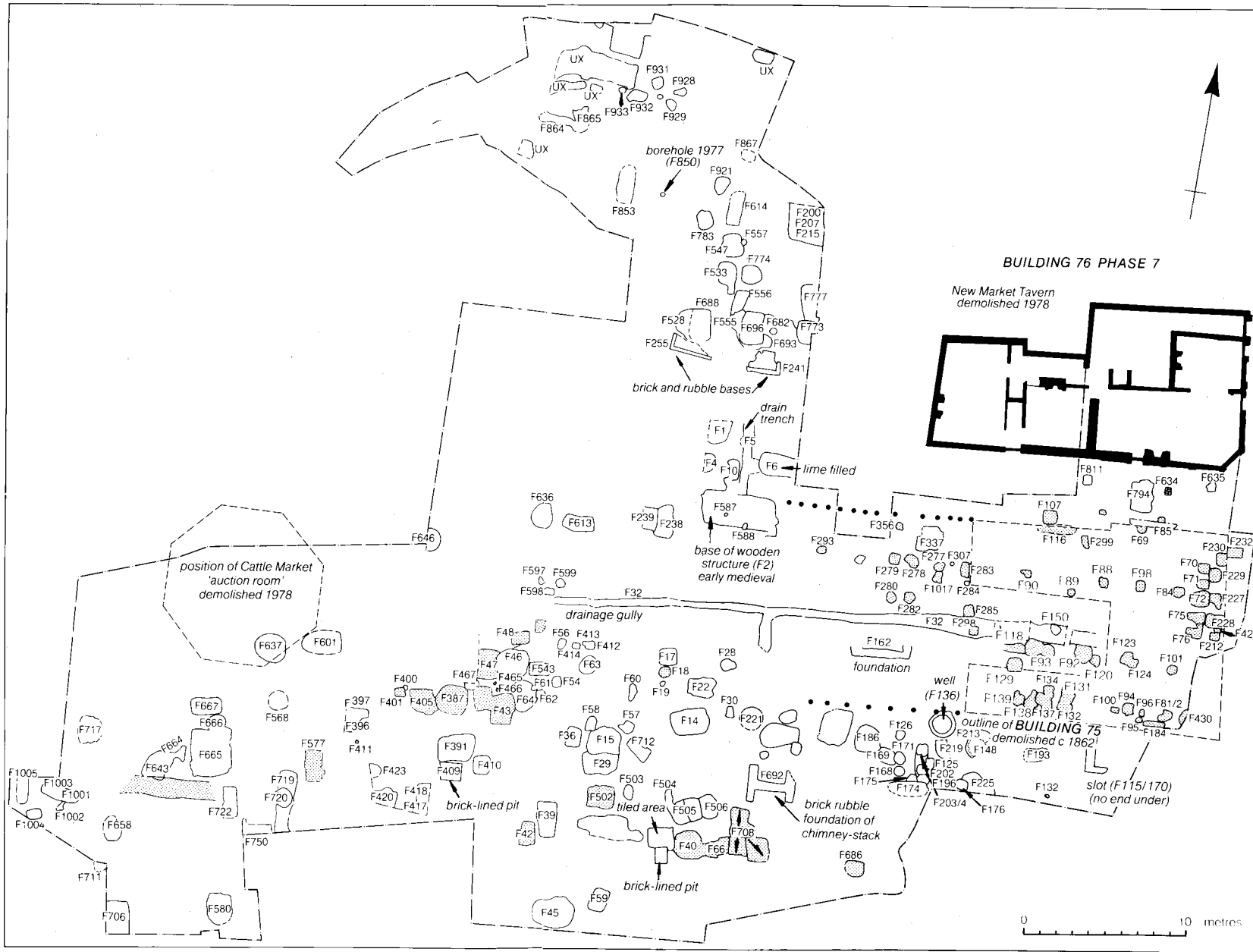


Fig 190 The latest features at Middleborough. Features probably associated with the Cattle Market are shaded. [Page 205]

A wooden floor was laid in the east room of the north wing. This was constructed of planks nailed to floor joists 500 mm apart. Dust which collected around the joists made the positions of the timbers clear and contained a coin of 1636-44 which must have slipped between the floor boards. Although there is no direct evidence for this, the remainder of the house was probably refloored in timber and, possibly much later, a brick floor was laid in the west room of the north wing. The fate of the south wing and the screens passage is difficult to determine but it seems likely that these were demolished at the beginning of Phase 6 (see further below).

The date and circumstances of the new plinths which were built over those of Phase 3 are also hard to understand. The plinths under the west walls of both the former open hall and the north cross-wing were replaced by plinths built of rubble bonded with daub whilst, along the east frontage, the replacement was of rubble and mortar. That the Phase 3 plinths were contemporary with the surviving north cross-wing was clear from the stumps of internal walls which were found during the excavation. These had been laid on plinths which were contiguous with the Phase 3 plinths on the street frontage and were identical in construction. They also mirrored the plan of the timbers of the south side of the surviving cross-wing so that the whole undoubtedly was of one build. The absence of brick or mortar in the new plinths makes it hard to date them much later than the 17th century. The difficulty is to explain how it was possible to replace the plinths of Phase 3 with new plinths at a higher level and yet retain the timber of the Phase 3 north wing. The explanation probably is that in about the 17th century the ground-floor timbers were removed (presumably because they were badly decayed) and these were replaced by new walls perhaps of brick inserted without the need to make new joints in any of the timbers. This is possible since very few of the original ground-floor timbers survived and all the walls in question had been demolished in the 19th or 20th century.

### Phase 7 (New Market Tavern; c 1862 to 1978)

[Plan Fig 190, p204; early plans of the Middleborough area Fig 191, p205]

In c 1862, Building 76 was extensively renovated and converted into the 'New Market Tavern' (Figs 190-1). A brick façade was built on the east and south sides with new windows and doors. On the east side, the jettied front was removed and replaced by a straight façade flush with the upper storey and, on the south side, the new wall was swung slightly southwards at the east end to enclose an external chimney-stack which had been added to the building probably not long before. On the south side, the gap between the new façade and the floors of the old building was bridged with a series of short north-south timbers (not shown in Figure 192, Sheet 5b). Later a brick, two-storeyed extension was added to the west side of the house.

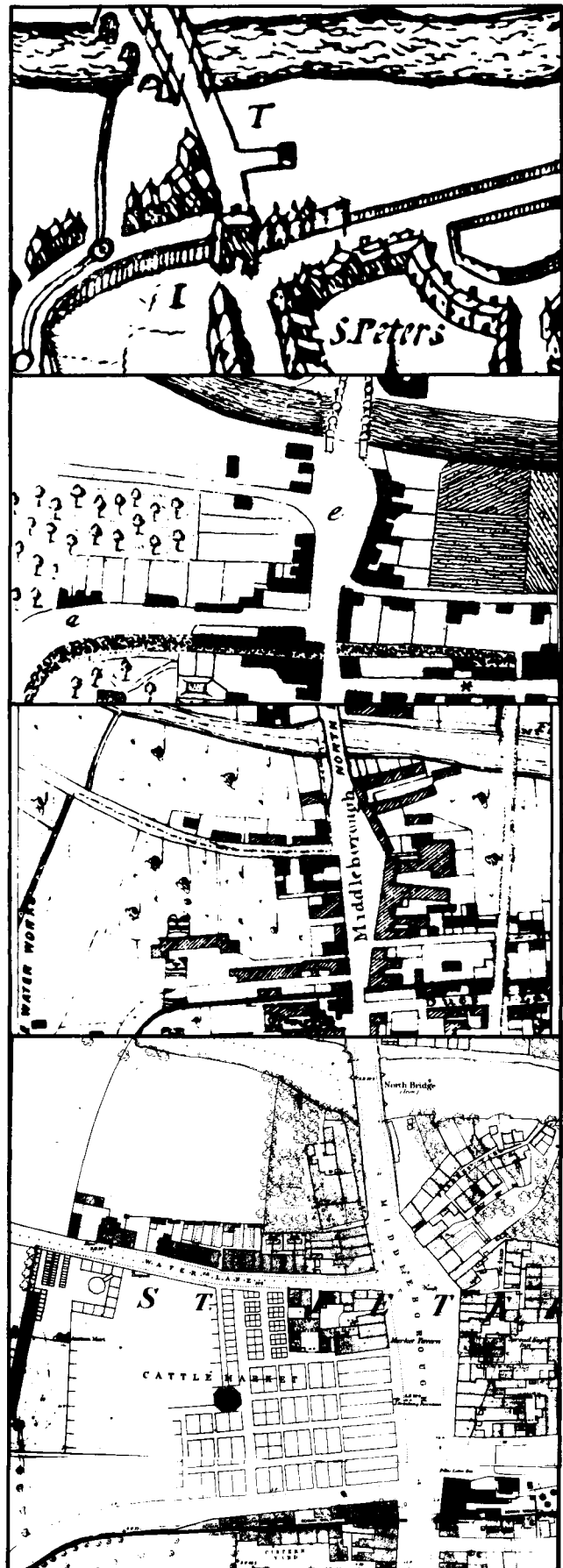
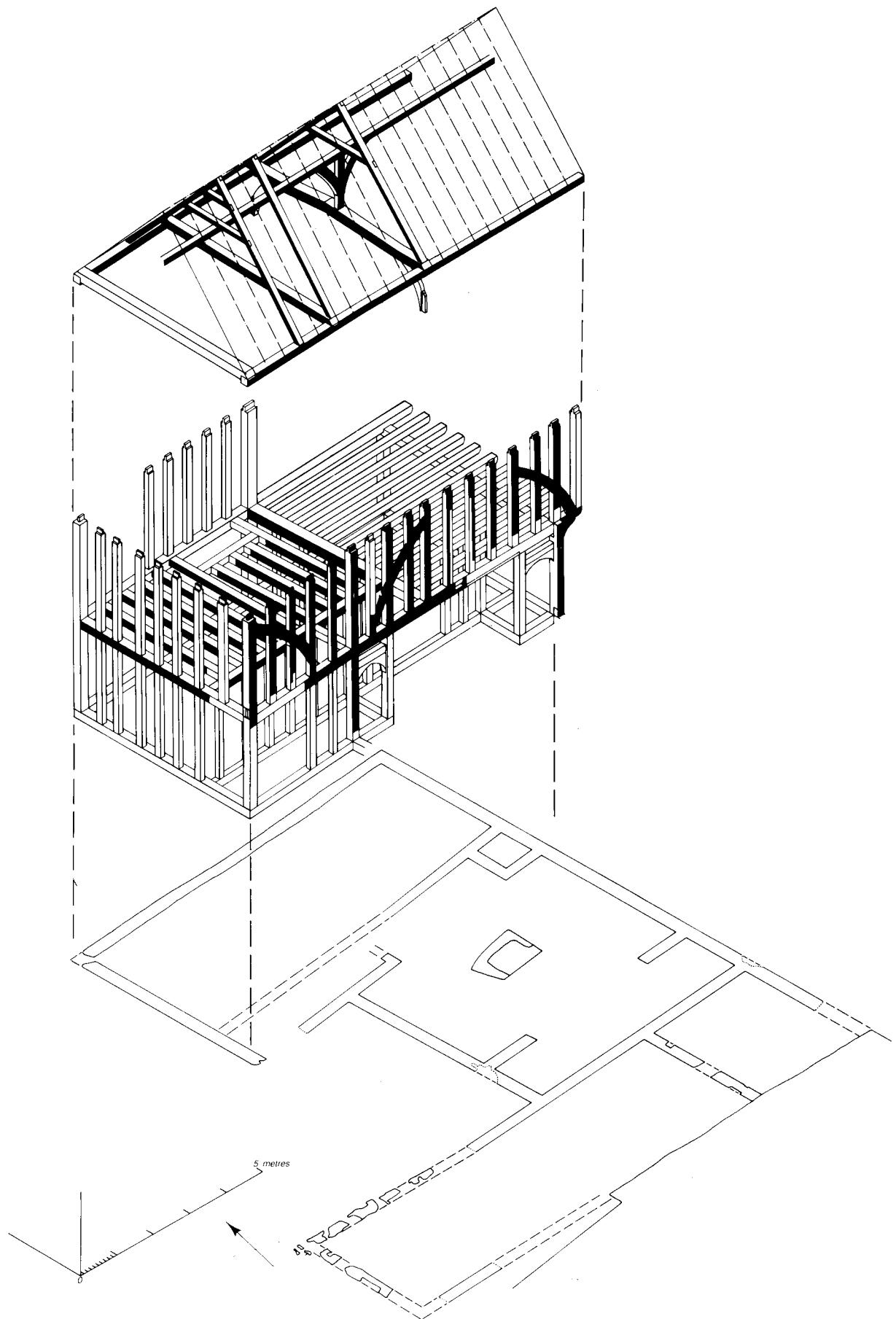


Fig 191 Early plans of Colchester: extracts showing the Middleborough area. Top to bottom: Speed 1610, Morant 1748 Monson 1848, and OS 1875. [Pages 205 & 209]



*Fig 193 The relationship of the surviving superstructure of Building 76, Phase 3 to the ground-plan of the same phase (below). [Page 207]*

## The surviving timber-frame of Building 76

[General plan Fig 193, p206; detail plans Fig 192, Sheet 5b, & Fig 194, p207]

In Figure 192, the parts of timbers shaded on one side are those parts which existed when the building was demolished; the unshaded sections have been restored on the basis of empty mortices or as missing parts of surviving timbers. The carpenter's marks, where found, are shown as well as the positions of two samples taken for radiocarbon dating. The timber-frame was of three periods corresponding to Phases 3, 5, and 6 above. Phase 4 was represented by a single, large, empty mortice.

Corresponding to the remains of Phase 3 below ground was a two-storeyed cross-wing with a crown-post roof (Fig 193). As far as could be gauged, the components of each roof truss (ie a pair of rafters and a collar) showed the same carpenter's mark. Only the trusses, not the whole roof, had been prefabricated elsewhere as independent units because the carpenter's marks had not been set out in the roof in numerical order. Most important were the empty mortices on the south face of the cross-wing indicating the positions of the top-plate and side-girths of an open hall which had stood on its south side (Figs 192 & 194). There had probably been a canopy over the central hearth since none of the timbers showed signs of smoke-blackening (p30).

The largest mortice of Phase 4 is without peg-holes and is on the south face of the south wall of the Phase 3 cross-wing (Fig 194). It is placed centrally to make a bridging joist for a floor inserted at first-floor level into the open hall of Phase 3. The south end of the bridging joist would have been built into the brick chimney-stack (F593) with which it was contemporary.

The rebuilt hall block of Phase 5 took the form of a three-storeyed structure which included an attic. Its construction must have meant the demolition of the Phase 4 chimney-stack since there were no gaps for the latter in the new floors. Apparently the Phase 3 cross-wing and the rebuilt hall block were not bonded together in a substantial way except perhaps in the roof (Fig 194). The top-plate forming the north edge of the Phase 5 attic floor lodged on the feet of the rafters of the cross-wing (Fig 192). The top-plates of Phase 5, where these survived (ie on all but the east side), had no mortices in their soffits. The south top-plate was thus very similar to the north one and therefore may also have been lodged on a pre-existing two-storeyed wing which in this case would have been to the south. The absence of mortices under the west top-plate is harder to understand; there are at least two explanations for the absence, both of which assume the use of brick walls. Either to the south and west, the walls of the Phase 5 rebuild were of brick (the jettied front was certainly retained) or there was a contemporary external chimney-stack on the west side of the Phase 5 block built in such a way that the timber-framed west wall was unnecessary. If the first of these explanations is correct, then there must have been no south wing by the start of Phase 5.

The floor at first-floor level in the Phase 5 block was

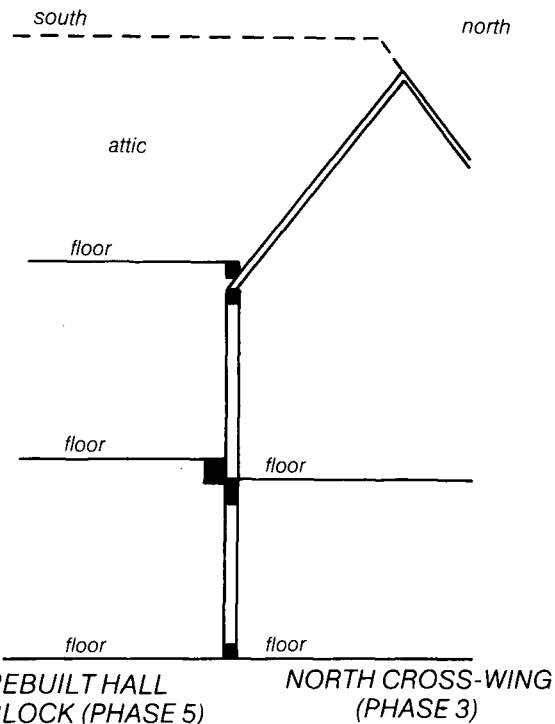
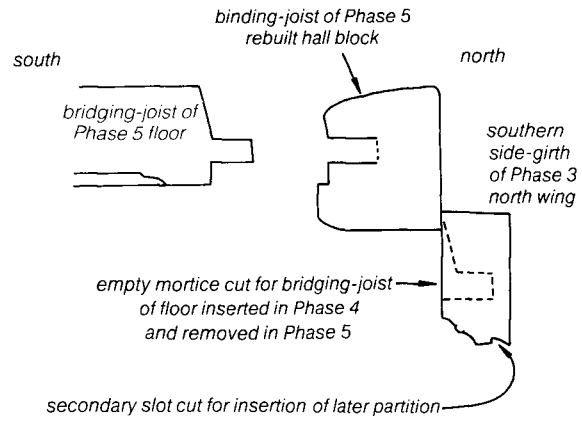


Fig 194 Building 76: the relationship of the Phase 5 hall block to the Phase 3 wing. [Page 207]

280mm higher than the corresponding one in the cross-wing (Fig 194). Its north side was formed by a substantial binding joist (Fig 194) for which curiously there was no corresponding member on the south side. Probably in Phase 7, the western half of the joist on the north side was removed. Very little of the Phase 5 roof survived except for a few rafters in the north-west side (not illustrated) which showed that it had been of the side-purlin type with a ridge set north to south.

In Phase 6, a three-storeyed extension which included an attic was added to the west side of the Phase 5 block so that the floors in both were level. The new structure seems to have been butted directly on to the existing building with the joists in the attic being lodged on the west top-plate of Phase 5 and its north side-girth tenoned into the west face of the south-west storey-post of the Phase 3 cross-wing (Fig



192). Breaks in the north and south top-plates of the Phase 5 and 6 structures, where they butt together, indicated clearly that the two units were of different periods. (Otherwise the timbers would have been laid as continuous members, scarf-jointed if necessary). Windows were provided in each storey of the new block including the attic and a gap was left in each floor for a chimney-stack. The square shape of the stack suggests that it had fireplaces to the west and east, not just on one side, and that therefore it could not have originally been an external chimney-stack on the west side of the Phase 5 block.

The sample of wood taken for radiocarbon dating from the Phase 3 cross-wing (HAR-3393, Fig 192) produced an uncorrected date of 1580-1720 whilst the sample from the rebuilt hall block of Phase 5 (HAR-3391; Fig 192) yielded the result ad 1640-1780. The samples were taken by Jennifer Hillam on behalf of the Department of the Environment and were of rings selected from complete cross-sections of the timbers. After making appropriate allowances for growth (*c* 48 years for HAR-3393 and *c* 40 years for HAR-3391) and with the aid of the Stuiver calibration curve (*Radiocarbon*, 24, no 1 (1982), 1-26), corrected felling dates for HAR-3393 and HAR-3391 respectively are as follows: 1528-1708 and 1570-1710 for one standard deviation and 1488-1848 and 1510-1900+ for two standard deviations. These date-ranges are rather too wide to be useful. However HAR-3393 seems to indicate that it is extremely unlikely (less than 1% chance) that the tree concerned was felled before *c* 1490. If correct, this would place the construction of the Phase 3 cross-wing at the very end of the 15th century at the earliest, thus making too early the date-range of 1450-1500 assumed in this report for this event. This radiocarbon date combined with the presence in the cross-wing of the simple central tenon suggests the wing was built 1490-1500. In retrospect, it might have been helpful to have taken several samples from the cross-wing, not just one.

The features in the timber-frame which have significant dating value can be summarized as follows:

#### *Phase 3 (1450/1500)*

- i) crown-post roof (up to *c* 1600; Hewitt 1969, 152)
- ii) central tenons used in floor joists (up to *c* 1450; Hewitt 1968, 195)
- iii) the use of stout timbers throughout (up to 16th century)
- iv) a corrected radiocarbon date of 1488+ (HAR-3393)
- v) the form of scarf-joint used in the south top-plate (15th to 17th centuries; Hewitt 1969, 183)

#### *Phase 5 (mid 17th century)*

- i) floor joists laid on edge (from *c* 16th century)
- ii) tenons with diminished haunches (from *c* 1520; Hewitt 1969, 200 & 206, & M Wadhams, pers com)

- iii) central tenon with diminished haunch and housed soffit shoulder probably limited to the late 16th and early 17th centuries (M Wadhams, pers com)
- iv) side-purlin roof (common from *c* 1550; Hewitt 1969, 152)
- v) a corrected radiocarbon date of 1510+ (HAR-3391)

#### *Phase 6 (late 17th century)*

- i) floor joists laid on edge (as above)
- ii) tenon with diminished haunch (as above)
- iii) side-purlin roof (as above)
- iv) window mullions with ovolo mouldings (*c* 1550 or later; Raglan 1963, 379)
- v) studs interrupted for continuous wind braces (not before the late 16th century; M Wadhams, pers com)

Mr M C Wadhams has kindly read the above account of the timber-frame of Building 76. He has stated that the occurrence of the straightforward central tenon as late as the 16th century would be very unusual and puzzling. This joint usually is found out of its normal period when the quality of the wood concerned renders a soffit tenon impractical. However this would not have been the case here. Also he suggests that the use of the central tenon with diminished haunch and housed soffit shoulder points to the construction of the Phase 5 structure probably being *c* 1650 at the very latest.

## **Summary of the development of Building 76**

[Fig 183, p197, & Fig 184, p198]

Little can be said about the plan of Phase 1 unless it had been the same as that of Phase 2 when the building consisted of an open hall with a service wing to the south (Figs 183-4). In Phase 3, the building took the form of an open hall with a wing to the north and a service wing plus, or including, a screens passage to the south. The screens passage was probably part of the ground-floor of the south wing in which case the arrangement of the roof must have been complicated. The hall by this stage was small and overhung at first-floor level by the south side of the upper room of the north wing and the part of the room of the south wing over the screens passage. The central hearth probably had a canopy and a timber-and-daub chimney above. In general, this stage represents the final development of the open hall where in its domestic context it had shrunk both in size and importance. In Phase 4, a chimney-stack and floor were inserted into the hall. In Phase 5, the modified hall block was demolished partly because the upper room formed in Phase 4 must have been unsatisfactory because of its limited headroom. Its replacement was a three-storeyed block which included an attic and which must have been slightly

taller than the adjacent earlier cross-wings. In Phase 6, another two-storeyed block with attic was built to the west. The date of the demolition of the south wing is not clear but it had been removed by 1848 since it does not appear on Monson's Map of Colchester (Fig 191, p205). Possibly the Phase 6 wing was intended as a replacement for the south wing, the demolition of which was carried out to allow direct access from the street to the rear of the property. In Phase 7, the existing south and east façades were replaced in brick and in 1978 the building was demolished.

### Other post-Roman features

[Plan Fig 190, p204]

The post-Roman remains at Middleborough described so far consist of the early medieval robber trenches, the 11th- to 12th-century kilns and Buildings 75 and 76. The remaining features of this date are illustrated in Figure 190.

The earliest of these features was F2. This was a shallow sub-rectangular pit or depression about 100mm deep with a shallow slot 50mm deep and 300mm wide around the base of its perimeter. There appeared to be no postholes. It was early medieval in date and was dug into the top of the latest Roman street surface. The purpose of the feature is unclear although it may have been the sunken floor of a building or a hut associated with the pottery kilns.

The concentration of post-medieval pits over the southern half of the site reflects the position of the back gardens of a row of houses which fronted the north side of Balkerne Lane (Fig 191, p205) and which was demolished when the Cattle Market was laid out. The base of the chimney-stack F692 belonged to one of these buildings. The latter were in existence by the time of Monson's map (1848) (Fig

191) and probably for some time before. The lining of the well (F136) was of stone and tile and, from its appearance and the absence in it of brick, was probably built no later than the 16th or 17th century. The well was in the north-east corner of the back gardens and was backfilled in the 19th century, probably when the market was built.

On the east side of the site were found several rows of modern pits which were associated with the market. These were the cause of much damage to the remains of Building 75. The gully F32 was possibly contemporary with them.

### Multi-storey car park site

[Fig 144, p156]

The site of the multi-storey car park lies between the main Middleborough site and the River Colne (Fig 144). To establish the archaeological potential of the area, several long trenches were dug by machine. The upper 1.5 m consisted of topsoil with no trace of any structural remains. Below this level the soil was waterlogged. It contained much gravel and overlay the natural clay which occurred about 2.0m below the modern ground level. Much broken wood was observed in the gravelly soil at the bottom of the trenches. It was mainly broken branches and twigs in thin jumbled masses but there was also the bottom of a large post *in situ* (Fig 144). This was about 0.3 m in diameter and had been broken off near its base. It was submitted for radiocarbon testing (HAR-3264) and an uncorrected date obtained of ad 1350-1490.

No further archaeological work was done on the site because the remains were too deep to be substantially disturbed during the building operations and the new building was to be erected on piles with minimal disturbance to the ground.

---

[Appendices 1 to 3 are on microfiche.]

### Appendix 4

#### Colchester ware louvers

by C M Cunningham

Five fragments of louvers (elaborate chimney pots or roof ventilators) were recovered from the Middleborough excavation. Their fabric is hard and sandy, containing many small white quartz grits, with a grey core and light brown surface. One piece (MID C740), however, has a smoother uniform grey fabric, and is possibly overfired. They are from large Type 1 louvers (Dunning 1966, 78), with at least one tier of triangular apertures surrounded by baffle-plates (Fig 200.1-3). The lower faces of the baffle-plates are joined by a plain, heavy horizontal flange. The only intact apex of a baffle-plate is surmounted by a small knob finial (Fig 200.3). Two of the fragments have a partial greenish lead glaze; two are also slip-painted. Indications of smoke-blackening on the inside survive.

Two fragments come from the Culver Street site. One (Fig 200.4) is a baffle-plate with a nib finial, and a thin green-flecked glaze. The other (not illustrated) is undecorated, and may be from a smaller, possibly square or rectangular vent, perhaps with a canopy. Another baffle-plate with a nib similarly glazed was found in the Castle bailey (Cunningham 1982, fig 28.41).

These examples share the same fabric, technique of construction and style of decoration, all of which correspond to 'Colchester ware', produced in or near Colchester in the late 13th to 14th centuries (*ibid*, 365-7).

Louvers in Colchester ware are found elsewhere in Essex. Part of a baffle-plate from West Bergholt (Drury forthcoming a) comes from an apparently large structure in a thin, relatively fine body, slipped overall and glazed. The front edge of the baffle-plate is gently thumbled, and its curvature towards the lost top suggests a superstructure. Another small fragment was found during field-walking at Lofts Farm, Heybridge (TL 865 088). It is coarse and thick-walled, unslipped with a patchy greenish glaze, and shows the base of one of the apertures, with a frilled band instead of a heavy plain flange running continuously below.

Of greatest significance, however, is the almost complete and very large louver excavated at Great Easton (Dunning 1966), distinguished by the addition of tall hollow finials to the tops of the baffle-plates. It can now be attributed to Colchester, and parallels for its remarkable construction have been found in

excavations in Moulsham Street, Chelmsford. Figure 200.5, 5A, and 5B show fragments probably from three almost identical louvers from Moulsham Street, from which the profile can be reconstructed. There are two tiers with staggered apertures, the upper tier being delimited by frilled bands. The shallow-domed top finishes in a hollow knob. The louver curves into a narrow base, with at least one peg-hole 20mm in diameter, 27mm from the bottom. The upper apertures are triangular, with baffle-plates once surmounted by hollow finials. It is not clear how many of these there were: Fig 200.5 has been reconstructed with five, which seems most likely from the size of the apertures, and agrees with the rather larger parallel from Great Easton. The lower tier has the same number of smaller apertures with canopies. Their shape is uncertain but is most likely square or rectangular. The tops of the finials and the canopies have been reconstructed based on Dunning's drawing of the Great Easton louver.

One of the louvers from Site S (59-63 Moulsham Street; Drury forthcoming b) is covered externally in a thick cream slip to within c 50mm of the base, and also on the inside of the baffle-plates, with a partial green-flecked clear lead glaze. At least one other specimen from Site S has a bold slip-painted pattern under a partial clear lead glaze. Part of another louver, from Site AG (23-27 Moulsham Street), is much larger and thus more comparable with the Great Easton one. It comprises a baffle-plate from the upper tier of apertures, showing the start of the finial attached in the same way as the others; part of the base of the aperture, the frilled band running immediately underneath; and the start of one of the lower vents in the staggered position, square-cut and with the canopy broken off. The whole is covered in a very thick cream slip, outside and underneath the baffle-plate, under a light green glaze.

In construction, the Great Easton louver is identical to the Chelmsford louvers, which very clearly demonstrate Dunning's description of the attachment of the finials to the tops of the baffle-plates (Dunning 1966, 76; see Fig 200.5b). Their smaller size, however, allowed the operation to be carried out in fewer stages: there is probably only one join, between the two rows of apertures, masked by the lower frilled band. The upper band is purely decorative. Sand impressions are visible under the base where it has been cut from the wheel, trimmed, and set down on a sanded surface. It is larger than many of the examples described above, however, and the baffle-plates are more neatly finished, without any trace of fingering; it is covered in an external cream slip, and there is no evidence of glazing, but the stylistic resemblance is clear.

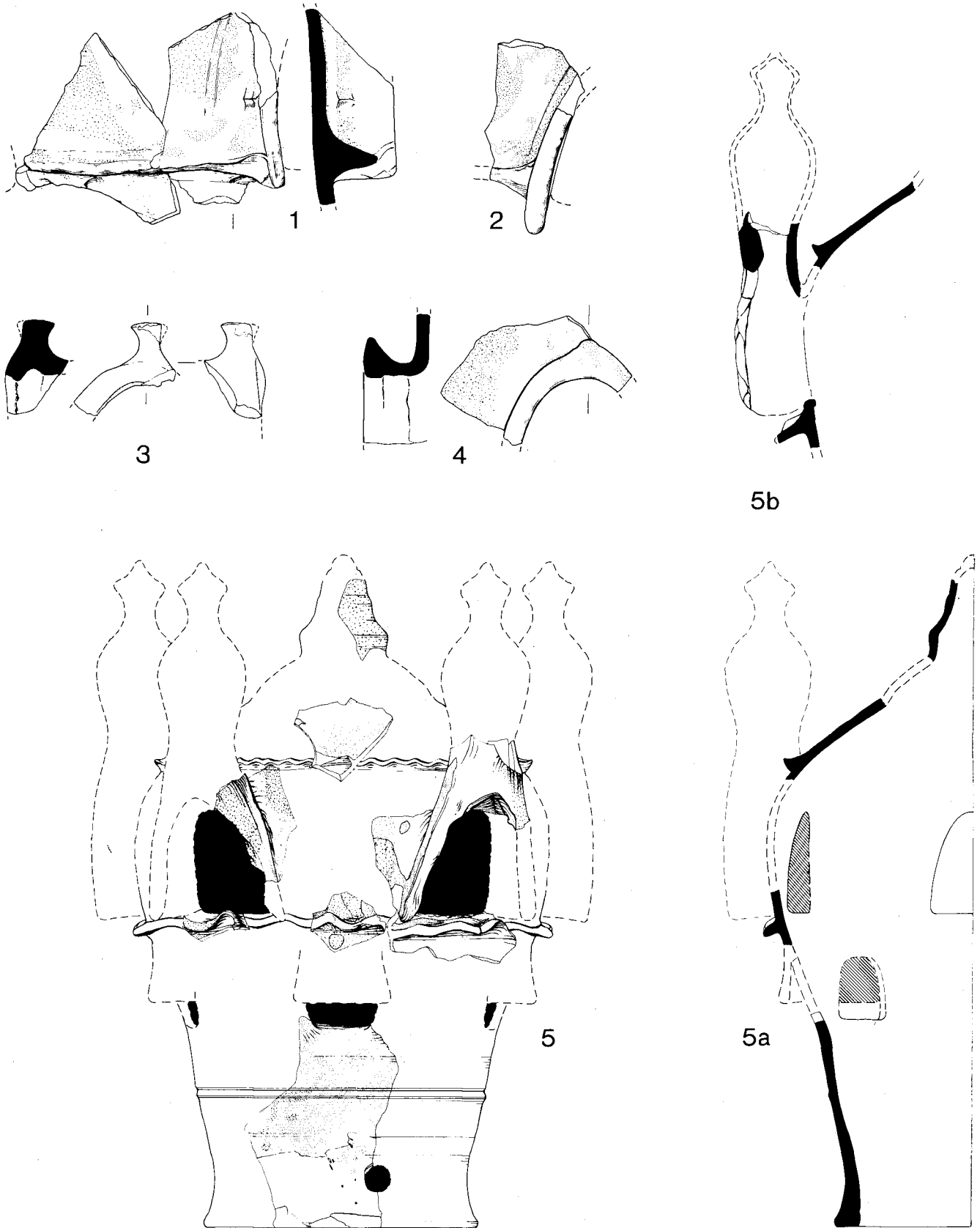


Fig 200 Louver fragments 1:4 (drawing by Chelmsford Archaeological Trust). 1...Middleborough, A7+A35, two fragments from 16th/17th-century pit F1 at rear of Buildings 75 and 76. 2...Middleborough, A7, same context as no 1, probably part of the same louver. 3...Middleborough, C1080, large 13th/14th-century slot F115 in plot south of Building 75. 4...Culver Street 1981, A10,

15th/16th-century pit F4. 5, 5a, & 5b...Moulsham Street, Chelmsford. Not illustrated: Middleborough, C740, topsoil accumulation L25, 13th/15th century. Middleborough C1431, metal surface of backyard, Building 75, Phase 3 (c 16th century). Culver Street 1981, A10, same context as no 4. [Pages 211-3]

Another louver was found at the Manor of the More, Rickmansworth, Herts (Dunning 1966, 79-80; 1959, 176-8). Its fabric and surface finish are visually identical to the others, despite its more distant provenance, but thin-section analysis would be necessary to confirm a Colchester origin.

### Discussion

Dunning (1966, 79) noted that the hollow finials on the dome and above the baffle-plates of the Great Easton louver were at that time unique. The only parallel then available in louvers was the specimen with spur finials from the Manor of the More. (He also quoted a fragment from Ely, which he later realised was part of a horned detachable finial belonging to a ridge tile, very much in the Grimston tradition (cf Clarke & Carter 1977, 298-300, fig 136.1-8).) Whilst no hollow finials have yet been found in Colchester itself, every louver in Colchester ware retaining the top of a baffle-plate shows some type of finial or terminal there. It is therefore clear that finials are characteristic of Colchester ware louvers.

Only two louvers not in the Colchester ware tradition are known in Essex. The first, from Waltham Abbey (Huggins 1978, 151, fig 18), is tentatively dated to the second half of the 15th century. Its form is quite different from the examples discussed here, but in thin-section analysis the fabric is identical to the Colchester ware group in Essex, except for a reduced quantity of opaque iron ore, and the absence of flint or chert, a very minor element in the Colchester ware fabric. It is possible, therefore, that it may be a product of potters local to the Waltham Abbey area. The second is a very small fragment in a gritty grey ware, found amongst material from a kiln site at Mill Green, Ingatestone (Pearce *et al* forthcoming), but its size precludes attribution with confidence either to a Type 1 louver, or to manufacture at Mill Green. Neither of these provide any evidence of finials.

The only other certain kiln site producing finialed louvers of Type 1 is Nash Hill, Lacock, Wilts (McCarthy 1974, 129-31; Dunning 1977, 121-2). These are of the same knob type as Fig 200.3 from Middleborough. A hollow knob finial from Battle Abbey, Sussex (Streeten forthcoming), however, most likely belongs to a louver and is probably a product of the Rye kilns.

Louvers could be used as ventilators, but the presence of smoke-blackening on most of the fragments indicates that they were used either as smoke-vents or chimney caps. Medieval stone chimneys were more often crowned with conical or polyhedral stone caps than open-topped. Many pottery louvers of Type 1 display features also found on these caps, particularly the string courses or flanges and triangular vents (Wood 1965, 183-4). In the 13th and 14th centuries many chimneys seem to have been constructed of wood and plaster or daub (*ibid*, 289), and would require caps of an appropriate medium. The Type 1 pottery louvers were probably designed for this purpose. Louvers of Type 2 (ridge tiles with an arrangement of canopied vents) on the other hand were clearly designed to sit on the roof over an open hearth.

All the examples so far found in Colchester resemble each other closely; their finials are small and restrained and their flanges are simple and prominent. In style, therefore, they would seem to spring from the stone, architectural models, and possibly represent the earliest earthenware louvers produced in Colchester. The architectural theme is also clearly demonstrated in a louver baffle-plate from Battle Abbey (Streeten forthcoming, fig 15). The examples from Great Easton and Chelmsford, with their elaborate thrown finials and frilled bands, display more of the potters' art, and may represent a developed, later version.

Methods of attaching louvers to the roof or chimney vary. The Chelmsford fragment (Fig 200.5) tapers directly to a narrow base, with a peg-hole. The Great Easton louver has a wider base with a plain lower flange on which the object can sit. It retains no evidence of peg-holes, but little survives of the base and lower flange. An example from Canterbury (Dunning 1966, 78) has peg-holes in the flange. The louver from Warmington (Dunning 1959, 17-8), however, has cut out of the base a rectangular slit, which must have served as the means of seating or attachment (cf copings, p202). No examples of louver bases have yet been recognised from Colchester.

### Dating

Some fragments from Middleborough came from contexts of c 13th- to 14th-century date, although, like the two from Culver Street, most were residual. That from the Castle bailey can be attributed to the late 13th to 14th centuries. The Great Easton louver is associated with the kitchen of a probable manor house, and is dated c 1300 or soon after (Dunning 1966, 74). Three of the slip-decorated fragments from Site S, Chelmsford, came from medieval contexts (Drury 1981, 54, F224, F1004, & F1027). They may perhaps have been broken in transit and discarded in the roadside ditch, since they are unabraded and free from smoke-blackening. Eight other pieces, possibly reused, are loosely associated with a probable detached kitchen in use c 1590-1630 (Drury forthcoming b), and are generally weathered and soot-blackened around the vents. The base was found in contexts dated c 1590-1730. The fragment from Site AG was built into a wall surrounding a garderobe pit, probably in the 14th century (Webster & Cherry 1976, 189). The louver from the Manor of the More is closely datable to 1370-80 (Wood 1965, 279).

Dunning (1959, 178, n 4) attributes louvers of this type to the late 13th and 14th centuries. This is compatible with the dating evidence presented here, since some of these objects may have been in use for considerable periods of time.

Figure 201 shows the distribution of known Colchester ware louvers and of Colchester ware pottery. The pots are relatively coarse, although competent enough, and seem to have fulfilled local market needs only. However, since Colchester ware has only recently been defined, further examples may

await identification elsewhere in north-east Essex. The louvers, however, were sufficiently remarkable that their much wider distribution causes no surprise.

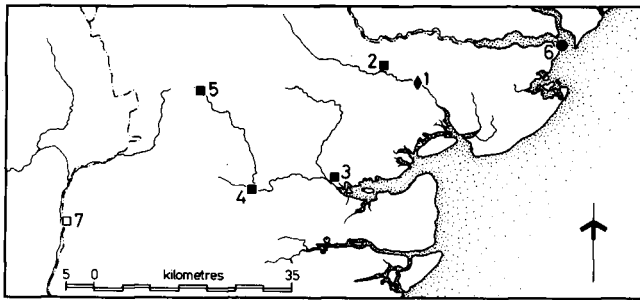


Fig 201 Louvers and Colchester ware in Essex. Colchester-type louvers: 1 ... Colchester, 2 ... West Bergholt, 3 ... Heybridge, 4 ... Chelmsford, 5 ... Great Easton, Colchester-ware pottery: 6 ... Harwich, 7 ... Waltham Abbey. [Pages 213-4]

[Appendices 5 and 6 are on microfiche.]

## Appendix 7

### Some technological finds from Lion Walk and Balcerne Lane

by Justine Bayley

A number of samples were selected for more detailed investigation from a large group of material seen by myself in Colchester. The samples have AML Nos 794745-50 apart from two crucible fragments (nos 1 & 2 below) received separately at a later date. All the analyses were carried out by x-ray fluorescence (XRF).

**AML No 794745** (Lion Walk Site J, Find Nos 1466, 1481, 1650, & 1702-4, Period 1)

The first group of material was a number of samples from or near to an area of intense burning (p36) which also produced quantities of blobs or dribbles of copper alloy. There were two main types of material present, the first being pieces of hearth or furnace lining which is clay that has been intensely heated from one side only so it is vitrified. The vitrified layer was up to 20 mm thick and coloured red in places by the presence of copper. Some pieces also contained droplets of metal which were analysed and shown to be leaded bronze (copper + tin + lead). Some of these hearth-lining fragments appeared to be parts of tuyères with internal diameters of 50-70 mm. This is considerably larger than is usually found and may be indicative of large-scale metal-working.

The second type of material noted appeared to be a slag of some sort. It was vesicular and glassy but very dense and usually coloured red, yellow and/or green. In all cases XRF detected lead as the major element present, together with some copper. This may be a by-product of the same process that produced the hearth lining and tuyères but it is worth noting that no tin was detected in any of these slag lumps while it was

universally present in the metal in the hearth lining and also in the pools and dribbles of metal which were in the samples.

Find No	hearth lining &/or tuyère	high lead slag	copper-alloy scrap
J1466	+		+
J1481	+	+	+
J1650	+	+	
J1702			+
J1703	+	+	+
J1704	+		

**AML No 794746** (Lion Walk, Site J, Find No 1558, Period 3)

AML No 794746 comprised crucible fragments from a layer of occupation associated with the Site J Period 3 furnace JF1600 + JF1601 + JF1651 (p52). Most of the fragments were from crucibles of similar size and shape, ie globular with an incipient pedestal base and a beaded rim. Wall thicknesses were about 4-6 mm and maximum external diameters about 80-100 mm. The most complete example is illustrated here (Fig 204.1). Where traces of metal survived they were analysed; all were bronzes containing some lead. Crucibles of a similar form have been found in Roman contexts at Baldock (Bayley forthcoming). There were also some sherds from smaller, thinner walled crucibles (2-3 mm wall thickness). One fragment had an everted rim with an internal diameter of about 30 mm (Fig 204.2). The metal on it was a leaded gunmetal (copper + zinc + tin + lead).

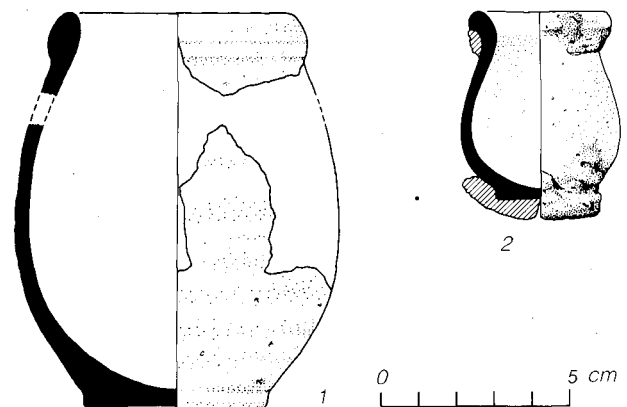


Fig 204 Crucible fragments from Building 16. [Page 214]

**AML No 794747** (Lion Walk Site J, Find Nos 1464 & 1563; JF184, Period 4)

AML 794747 also consisted of crucible fragments. They came from redeposited material and were clearly residual; they probably came from the same group of material as the crucibles described above (AML No 794746). Again a number of vessels were represented including at least one with an incipient pedestal base (as above) and at least one with thinner walls.

**AML No 794748** (Lion Walk Site B, Find No 248; Period 3 or 4; Find No 412, BF148, Period 5)

The fragment from LWC B248 was a body sherd with traces of leaded gunmetal while B412 was part of a small, thin-walled (4 mm) crucible with an incipient pedestal base. Analysis of the inner surface detected silver together with traces of copper and lead, suggesting the crucible was used for melting silver rather than the copper alloys which appears to be what the rest of the crucibles once contained.

**AML No 794749** (Lion Walk Site G, Find No 151, GF71, c 1150-1500)

AML No 794749 is spilt molten lead (p77). The various shapes it takes are casts of the organic materials it fell on to; wood and non-woody plants, perhaps rushes, are identifiable. The form of the lead is accidental and has nothing to do with metalworking.

**AML No 794750** (Balkerne Lane, Site G, Find No 31, modern)

AML No 794750 is a rim sherd of a crucible which had an internal diameter of about 40 mm. It is probably of Roman origin. The metal on it is leaded gunmetal.

**Crucible fragment no 1** (Balkerne Lane, Site V, Find No 155, VF42, Period 4)

Fragment of a late Iron Age/Early Roman crucible. The pouring lip pinched out of the rim of a shallow hemispherical crucible. Traces of copper were detected. Similar crucibles were found in the Sheepen excavations of 1970 (Dunnett forthcoming).

**Crucible fragment no 2** (Balkerne Lane, Site H, Find No 63, HF28, Period 6)

Base of a crucible (similar to those illustrated in Figure 204). Metal is leaded gunmetal. External diameter of base is 3 cms.

[Appendices 8 to 15 are on microfiche.]

# BIBLIOGRAPHY

## ABBREVIATIONS

- BAR British Archaeological Reports  
CAR Colchester Archaeological Reports  
CAR 1 P Crummy, *Aspects of Anglo-Saxon and Norman Colchester*, CBA Research Report, **39** (1981)  
CAR 2 N Crummy, *The Roman small finds from excavations in Colchester, 1971-9*, (1983)  
CBA Council for British Archaeology  
CMR *Report of the Colchester and Essex Museum*  
CIL *Corpus Inscriptionum Latinarum*  
OS Ordnance Survey  
RCHM York Royal Commission on Historical Monuments, *Eboracum, Roman York* (1962)

## REFERENCES

- Aurigemma, S, 1926 *I mosaici di Zliten*  
Baratte F, 1978 *Mosaïques romaines et paléochrétiennes du Musée du Louvre*  
Barbet, A, 1974 *Peintures murales de Mercin-et-Vaux (Aisne): étude comparée, 1, Gallia, 32, 107-35*  
Bastet, F L & De Vos, M, 1979 *Proposta per una classificazione del terzo stile pompeiano*, Archeologische Studien van het Nederlands Instituut te Rome, **4**  
Bayley, J, forthcoming *The metalworking evidence, in I Stead, Excavations at Baldock, Herts*  
Beaton, E & Moran, M, 1977 *A cottar house with a 'hingin' lum, Vernacular Architect, 8, 834-837*  
Becatti, G, 1961 *Scavi di Ostia 4: mosaici e pavimenti marmorei*  
Bellhouse, R L, 1954 *Roman sites on the Cumberland coast, 1954, Trans Cumberland Westmorland Antiq Archaeol Soc, 54, 28-55*  
Blagg, T, 1979 *The use of terra-cotta for architectural ornament in Italy and the western provinces, in McWhirr 1979, 267-84*  
Blake, M E, 1936 *Roman mosaics of the second century in Italy, Memoirs of the American Academy in Rome, 13*  
Boon, G C, 1974 *Counterfeit coins in Roman Britain, in Coins and the Archaeologist (eds P J Casey & R Reece), 95-172, BAR, 4*  
Brothwell, D R, 1972 *Digging up bones*  
Brunskill, R W, 1962 *The clay houses of Cumberland, Trans Ancient Monuments Soc, n ser, 10, 57-80*  
Bulleid, A & Horne, E E, 1926 *The Roman house at Keynsham, Somerset, Archaeologia, 75 (1924-5), 109-38*  
Cătănciu, I B, 1981 *Evolution of the system of defence works in Roman Dacia, BAR International Series, 116*  
Clarke, H & Carter, A, 1977 *Excavations in King's Lynn 1963-1970, Medieval Archaeol Mono, 7*  
Croisille, J-M, 1965 *Les natures mortes campaniennes (Collection Latomus, 76)*  
Crummy, P, 1977 *Colchester: the Roman fortress and the development of the colonia, Britannia, 8, 65-105*  
———, 1980a *The temples of Roman Colchester, Temples, churches and religion: recent research in Roman Britain (ed W Rodwell), BAR, 77*  
———, 1980b *Errors in a mosaic found at Colchester, Essex, England and a method of drawing mosaic pavements, Bulletin de l'Association Internationale pour l'Etude de la Mosaïque Antique, 8, 217-24*  
———, 1982a *The origins of some major Romano-British towns, Britannia, 13, 125-34*  
———, 1982b *The Roman theatre at Colchester, Britannia, 13, 299-302*  
Cunliffe, B, 1971 *Excavations at Fishbourne 1961-1969, 1*  
———, 1977a *The Saxon Shore — some problems and misconceptions, in The Saxon Shore (ed D E Johnston), 1-6, CBA Research Report, 18*  
———, 1977b *Excavations at Portchester Castle, 3*  
Cunningham, C M, 1982 *Medieval and post-medieval pottery, in Drury 1982, 358-80*  
———, forthcoming *A typology for post Roman pottery in Essex, in Cunningham & Drury forthcoming*  
Cunningham, C M & Drury, P J, forthcoming *Post-medieval sites and their pottery, Chelmsford Archaeol Trust Report, 5*  
Dale, S, 1732 *The history and antiquities of Harwich and Dovercourt in the county of Essex by Silas Taylor (ed S Dale)*  
Davey, N, 1972 *The conservation of Romano-British painted plaster, Britannia, 3, 251-68*  
Davey, N & Ling, R J, 1982 *Wall painting in Roman Britain, Britannia Monograph Series, 3*  
Dentoni, M & Kurent, T, 1963 *The modular reconstruction of Emona*  
Drury, P J, 1976 *Braintree: excavations and research 1971-76, Essex Archaeol Hist, 8, 1-143*  
———, 1981 *Medieval 'narrow rig' at Chelmsford and its possible implications, Landscape Hist, 3, 51-8*  
———, 1982 *Aspects of the origins and development of Colchester Castle, Archaeol J, 139, 302-419*  
———, forthcoming a *Ceramic building materials, in B R G Turner, Excavations at St Mary's Church, West Bergholt, Essex, 1978, East Anglian Archaeology forthcoming*  
———, forthcoming b *The excavations, in Moulsham Street, Chelmsford in Cunningham & Drury forthcoming*  
Drury, P J & Norton, E C, forthcoming *The medieval tiles of Essex, Suffolk and Cambridgeshire*  
Drury, P J & Petchey, M R, 1975 *Medieval potteries at Mile End and Great Horkesley, near Colchester, Essex Archaeol Hist, 7, 33-60*  
Dunbabin, K M D, 1978 *The mosaics of Roman North Africa*  
Duncan, P M, 1858 *The Roman cloaca at Colchester: its discovery and description, Trans Essex Archaeol Soc, 1st ser, 1, 210-28*  
Dunnett, B R K, 1967 *Excavations on North Hill, Colchester, Archaeol J, 73, 27-61*  
———, 1971 *Excavations in Colchester, 1964-8, Trans Essex Archaeol Soc, (3rd ser), 3, 1-106*  
———, forthcoming *Sheepen; an early Roman industrial site at Camulodunum, CBA Research Report*  
Dunning, G C, 1959 *Roof structures, in M Biddle, L Barfield, & A Millard, The excavation of the Manor of the More, Rickmansworth, Archaeol J, 116, 176-8*  
———, 1966 *A pottery louver from Great Easton, Essex, Medieval Archaeol, 10, 74-80*  
———, 1977 *Louver in Cunliffe 1977b, 121-2*  
Eames, E S, 1975 *Decorated tile pavements in English medieval houses, Rotterdam Papers II, A contribution to medieval archaeology, 5-15*  
Evans, J G, 1972 *Land snails in archaeology*  
Faccenna, D, 1958 *Rilievi gladiatorii, Bullettino del Museo della Civiltà Romana, 19 (Bullettino della Commissione Archeologica Comunale, 76, (1956-8)), 37-75*  
Fentress, E, 1979 *Numidia and the Roman army, BAR International Series, 53*  
Filtzinger, P, 1963 *Zur Lokalisierung der Zweilegionsfestung apud aram Ubiorum, Kölner Jahrbuch für Vor- und Frühgeschichte, 6 (1962-3), 23-31*  
Fishwick, D, 1972 *Templum divo Claudio constitutum, Britannia, 3, 164-81*  
Frere, S S, 1974 *Britannia*  
Frova, A, 1949 *The Danubian limes in Bulgaria, and excavations at Oescus, The congress of Roman frontier studies (ed E Birley), 23-30*  
Gallois, R W, 1965 *The wealden district, British Regional Geology Series*  
Garlan, Y, 1965 *Nouvelles mosaïques thasiennes, Bulletin de correspondance Hellénique, 89, 567-83*



- Gillam, J P, 1970 *Types of Roman coarse pottery vessels in northern Britain*
- Goodburn, R, 1979 Roman Britain in 1978, *Britannia*, **10**, 268-338
- Green, C J, 1977 The significance of plaster burials for recognition of Christian burials, *Burial in the Roman world* (ed R Reece), CBA Research Report, **22**, 46-52
- Grew, F O, 1980 Roman Britain in 1980, *Britannia*, **11**, 346-402
- Hanson, W S & Keppie, L F J (eds), 1980 *Roman frontier studies 1979*, BAR International Series, **71**
- Hassall, M W C, & Tomlin, R S O, 1977 Roman Britain in 1976: inscriptions, *Britannia*, **8**, 426-49
- Hawkes, C F C & Hull, M R, 1947 *Camulodunum*
- Helbaek, H, 1952 Early crops in southern England, *Proc Prehist Soc*, **18**, 194-233
- Hewitt, C A, 1969 *The development of carpentry 1200-1700*
- Hinks, R, 1933 *Catalogue of the Greek, Etruscan, and Roman paintings and mosaics in the British Museum*
- Hodges, H, 1976 *Artifacts*
- Huggins, R M, 1978 Appendix 2: the louver, in A E S Musty, Exploratory excavation within the Monastic Precinct, Waltham Abbey, 1972, *Essex Archaeol Hist*, **10**, 151
- Hull, M R, 1955 The south wing of the 'forum' at Colchester, *Trans Essex Archaeol Soc*, 2nd Ser, **25** (1955-60), 24-61
- , 1958 *Roman Colchester*
- , 1960 St Nicholas Church site, Colchester, *Trans Essex Archaeol Soc*, 2nd Ser, **25** (1955-60), 301-28
- , 1963 *The Roman potters' kilns of Colchester*
- Hundt, H-J, 1970 *Gewebefunde aus Hallstatt. Webkunst und Tracht in der Hallstattzeit*
- Ivanov, T, 1977 Untersuchungen zur Topographie und zur Stadtanlage von Oescus in Untermoesien (Bulgarien), *Studien zu den Militärgrenzen Roms*, **2**, 339-50
- , 1980 Untersuchungen des Forumkomplexes in der *Colonia Ulpia Oescensium* (1975-1978), in Hanson & Keppie 1980, 775-87
- Jackson, J W, 1947 Mammalian remains, in Hawkes & Hull 1947, 350-4
- Jessup, R, 1954 Excavation of a Roman barrow at Holborough, Snodland, *Archaeol Cantiana*, **68** (1954), 1-61
- Johnson, S, 1976 *The Roman Forts of the Saxon Shore*
- Jones, G D B, & Grealey, S, 1974 *Roman Manchester*
- Jones, M, 1978 The plant remains, in M Parrington, *The excavation of an Iron Age settlement, Bronze Age ring-ditches and Roman features at Ashville Trading Estate, Abingdon (Oxfordshire) 1974-6*, CBA Research Report, **28**
- Kapossy B, 1966 *Römische Wandmalereien aus Münsingen und Hölstein*, Acta Bernensia, **4**
- Keen, L, 1969 A series of seventeenth and eighteenth-century lead-glazed relief tiles from north Devon, *J British Archaeol Ass*, 3rd Ser, **32**, 144-70
- Keepax, C, 1975 Scanning electron microscopy of wood replaced by iron corrosion products, *J Archaeol Sci*, **2**, 145-50
- Körber-Grohne, U, 1964 Bestimmungsschlüssel für subfossile Juncus—Samen und Gramineen—Früchte, in W Haarnagel, *Probleme der Küstenforschung im Südlichen Nordseegebiet*, **7**, 32-47, Hildesheim
- Kraus, T, 1967 *Das römische Weltreich*, Propyläen Kunstgeschichte, **2**
- La Baume, W, 1955 *Die Entwicklung des Textilhandwerks in Alteuropa*
- Lancha, J, 1981 Recueil général des mosaïques de la Gaule, **3**, Narbonnaise, **2**
- Lauffer, S, 1971 *Diokletians Preisedik*
- Levi, D, 1947 *Antioch mosaic pavements*
- Linfert, A, 1973 Römische Wandmalereien aus der Grabung am Kölner Dom, *Kölner Jahrbuch für Vor- und Frühgeschichte*, **13** (1972-3), 65-76
- Liversidge, J, 1955 *Furniture in Roman Britain*
- Lysons, S, 1817 *Reliquiae Britannico-Romanae*, **3**
- Macphail, R I, 1981a Soil and botanical studies of the 'dark earth' in *The environment of man: the Iron Age to the Anglo-Saxon period* (eds M Jones and G Dimbleby), 309-29, BAR, **87**
- , 1981b The micromorphology of 'dark earth' from Gloucester, London and Norwich, in *6th working meeting on soil micromorphology, London* (eds P Bulloch and C P Murphy)
- Mann, J, C, 1962 *Colonia Ulpia Traiana* and the occupation of Vetera II, *Bonner Jahrbücher*, **162**, 162-4
- Marples, B J, 1974 Animal bones, in S S Frere & J K St Joseph, The Roman fortress at Longthorpe, *Britannia*, **5**, 122-8
- Marsh, G & West, B 1983 Skullduggery in Roman London, *Trans London Middlesex Archaeol Soc*, **32** (1981), 86-102
- Martinez, A B, 1976 Caesaraugusta, *Symposion de cuidades augusteas*, **1**, 219-61
- Mazois, F, 1824 *Les ruines de Pompéi*, **1**
- McCarthy, M R, 1974 The medieval kilns on Nash Hill, Lacock, Wiltshire, *Wilts Archaeol Natur Hist Mag*, **69**, 97-160
- McWhirr, A, 1979 *Roman brick and tile*, BAR International Series, **68**
- Meates, G W, 1979 *The Roman villa at Lullingstone, Kent*
- van Mensch, P J & Ijzereef, G F, 1977 Smoke-dried meat in prehistoric and Roman Netherlands, *Ex Horreo* (IPP 1951-6), 144-50
- Mócsy, A, 1974 *Pannonia and upper Moesia*
- Morant, P, 1748 *The history and antiquities of the most ancient town and borough of Colchester*
- Morris, M O, 1955 Notes on the decorative and building stones from the temple site, in Hull 1955, 47-50
- Neal, D S, 1976 Three Roman buildings in the Bulbourne valley, *Hertfordshire Archaeol*, **4** (1974-6), 1-135
- , 1981 *Roman mosaics in Britain: an introduction to their schemes and a catalogue of paintings*, Britannia Monograph Series, **2**
- Noddle, B A, 1974 in P J Casey, Excavations at Segontium, 1971, *Archaeol Cambrensis*, **123**, 75-7
- Oswald, F, 1937 *Index of figure types on terra sigillata*
- Peacock, D P S, 1977 *Pottery and early commerce, characterisation and early trade in Roman and later ceramics*
- Pearce, J E, Vince A G, & White, R, with Cunningham, C M, forthcoming A dated type series of London medieval pottery, Part 1: Mill Green Ware, *Trans London Middlesex Archaeol Soc*, **33**
- Peters, W J T, 1977 La composizione delle pareti dipinte nella Casa dei Vetti a Pompei, *Mededelingen van het Nederlands Instituut te Rome*, **39**, 95-128
- von Post, L, von Walterstorff, E, & Lindqvist, S, 1925 *Bronsåldersmantein från Gerumsberget i Västergötland*
- Price, J, 1977 The glass, in C Saunders & A B Havercroft, A kiln of the potter *Oastrius* and related excavations at Little Munden Farm, Bricket Wood, *Hertfordshire Archaeol*, **5**, 109-56
- Raglan Lord, 1963 The origins of vernacular architecture, *Culture and environment* (eds I L L Foster & L Alcock)
- Ransom, L, 1903 *Couches and beds of the Greeks, Etruscans and Romans*
- Rees, S E, 1979 *Agricultural implements in Prehistoric and Roman Britain*, BAR British Series, **69** (1)
- Richter, G, 1966 *Furniture of the Greeks, Etruscans and Romans*
- Robert, L, 1940 *Les gladiateurs dans l'orient grec*, Bibliothèque de l'Ecole des Hautes Etudes, **278**
- Rook, A, G, 1975 *Aspects of the design and operation of hypocausted baths in rural Britain*, unpublished thesis, University of London Institute of Archaeology
- , 1977 The building materials, in C Partridge, Excavations and fieldwork at Braughing, 1968-73, *Hertfordshire Archaeol*, **5**, 24-64
- , 1979 Tiled roofs, in McWhirr 1979, 295-301
- Rudkin, D, 1981 Recent discoveries at Fishbourne Palace, *Mosaic* (Newsletter of the Association for the Study and Preservation of Roman Mosaics), **4**, 8-10
- Salomonson, J W, 1964 *Rom in Karthago* (catalogue of exhibition, Cologne 1964)
- Salmon, E T, 1969 *Roman colonisation under the Republic*
- Salzman, L F, 1967 *Building in England down to 1540*
- Sarnowski, T, 1977 Fortress of the *Legio 1 Italica* at Novae, *Limes: Acten des XI Internationalen Limeskongresses* (ed J Fitz), 409-26
- Sherlock, R L, 1960 *London and the Thames valley*, British Regional Geology Series
- Scheffold, K, 1962 *Vergessenes Pompeji*
- Singer, C, Holmyard, E J, Hall, A R, & Williams, T I (eds), 1956 *A History of Technology*, **2**
- Smith, D J, 1969 The mosaic pavements, *The Roman villa in Britain* (ed A L F Rivet), 71-125
- , 1967 The mosaics, in Dunnett 1967, 40-2
- , 1975 Roman mosaics in Britain before the fourth century, *La mosaïque gréco-romaine*, **2** (eds H Stern & M Le Glay), 269-89
- , 1980 Mosaics, in I Stead, *Rudston Roman villa*, 131-8
- , forthcoming Roman mosaics in Britain: a synthesis,

- Atti del III colloquio internazionale sul mosaico antico, Ravenna, 1980*
- Speed, J, 1610 *Theatre of the empire of Great Britain*
- Stambelov, T, 1968 *The corrosion and conservation of metallic antiquities and works of art*
- Streeten, A D F, forthcoming Ceramic building materials, in J N Hare, *Battle Abbey, Sussex: the eastern range and the excavations of 1978-80*
- Stevenson, J, 1978 *The catacombs*
- Thompson, F H 1954 The Roman aqueduct at Lincoln, *Archaeol J*, **111**, 106-28
- Toller, H, 1977 *Roman lead coffins and ossuaria in Britain*, BAR, **38**
- Toynbee, J M C, 1954 The lead sarcophagus, in Jessup 1954, 34-46
- , 1962 *Art in Roman Britain*
- Trotter, M & Gleser, G C, 1952 Estimation of stature from long-bones of American whites and negroes, *Amer J Physical Anthropol*, **10**, 463-514
- Trotter, M & Gleser, G C, 1958 A re-evaluation of estimation of stature based on measurements of stature taken during life and long-bones after death, *Amer J Physical Anthropol*, **16**, 79-123
- Wacher, J, 1974 *The towns of Roman Britain*
- Walthew, C V, 1975 The town house and the villa house in Roman Britain, *Britannia*, **6** (1974), 189-205
- Watson, J, 1976 *An experimental revaluation of the methods used to remove incrustations from lead and pewter antiquities*, unpublished undergraduate dissertation, University of London
- Webster, G, 1969 *The Roman imperial army*
- , 1979 Tiles as a structural component in buildings, in McWhirr 1979, 285-93
- Webster, L E & Cherry, J, 1976 Medieval Britain in 1975, *Medieval Archaeol*, **20**, 158-201
- Wells, C M, 1972 *The German policy of Augustus: an examination of the evidence*
- Wheeler, R E M, 1921 An insula of Roman Colchester, *Trans Essex Archaeol Soc*, 2nd Ser, **16**, 7-41
- , 1936 *Verulamium, a Belgic and two Roman cities*
- Wild, J P, 1970 *Textile manufacture in the northern Roman provinces*
- , 1977 The textiles, in *Vindolanda*, **3**
- Williams, D F, 1977 The Romano-British black-burnished industry: an essay on characterisation by heavy mineral analysis, in Peacock 1977, 163-220
- Williams, J, H, 1971 Roman building materials in south-east England, *Britannia*, **2**, 166-85
- Wilson, R J A, 1979 Brick and tiles in Roman Sicily, in McWhirr 1979, 11-43
- , 1982 Roman mosaics in Sicily: the African connection, *American Journal of Archaeology*, **86**, 413-28
- Wood, M, 1965 *The English medieval house*
- Woods, P J, 1970 Brixworth excavations, *J Northampton Mus Art Gallery*, **8**, 3-102
- van Zeist, W, 1970 Prehistoric and early historic food plants in the Netherlands, *Palaeohistoria*, **14**, 42-173

# INDEX

- Alignments, of Roman colony, fortress, and theatre 3, 8-9, 37
- Alleys (Roman) 105, 110-11, 119, 155, 158-9
- Allotments (Roman) 17, 113, 135, 138-41, Figs 105-6, 112, 128-30, 141-2, App 10  
(post-Roman) 153  
see also Gardens
- Almshouses 82, 87
- ?Altar (Roman) 165-6, Fig 155
- Ammaedara, Africa (Algeria) 10
- Anglo-Saxon Colchester 29
- Anglo-Saxon huts 19, 29, 57, 70, 73-5, Figs 59, 61
- Animal bone 93-4, 102, 127  
see also Burials, animal
- Annexe, see Fortress
- Antioch, Syria 57, 60
- Aosta, Italy 10-11
- Apse (Roman) 162, 165
- ?Aqueduct 28, 111, 115, 119-21, Figs 99, 101, 112
- Arch, monumental 19, 24-5, 29  
see also Balcerne Gate
- Archaeological Research Group, Colchester 5
- Architectural fragments, stone App 3
- Asparagus 140
- Attic (post-medieval) 207-8
- Baldock, Hertfordshire 214
- Balcerne Gate 15-16, 18, 27, 30, 111, 113, 117, 121-3, 126, 153, Figs 99-100, 102-3, 105-6, 113-14  
see also Arch, monumental
- Balcerne Hill 15, 27, 145-6, 154
- Balcerne Lane 154, 162, 209
- Balcerne Lane site 93-154  
Roman buildings:  
Building(s) 34 93, 99, 102, Figs 80-1, 87  
Building 35 93, 101-2, Figs 80-1, 87  
Building 36 93, 101-2, Figs 80-1, 87  
Building(s) 37 8-9, 93, 101-2, Figs 80-2, 88-9  
Building 38 93, 102, 105, 110, Figs 80-1, 90-1, App 11  
Building 39 103-5, Figs 90-2  
Building 40 103-5, Figs 90-2  
Building 41 103-5, Figs 90-2, App 11  
Building 42 103-5, Figs 90-2  
Building 43 105, Figs 84, 90-1  
Building 44 8-9, 11, 20, 23, 25-6, 101-3, 105-7, 110, 115, 135, Figs 90-1, 93-5  
Building 45 8-9, 11, 20, 23, 25, 101-3, 105, 107-8, 110, 115, 135, Figs 90-1, 93, App 11  
Building 46 8-9, 11, 20, 23, 25, 93, 101-2, 105, 108-10, 115, 135, Figs 90-1, 93, 96  
Building(s) 47 20, 23, 117-19, Figs 99, 101, 110, App 8  
Building 48 119, Figs 99, 101, 110  
Building 49 119, Figs 99, 101, 110  
Building 50 119, Figs 99, 101, 110  
Building 51 25, 115, 119, 121, 135, 138, 147-53, Figs 99, 111, 137-42  
Building 52 15, 18, 20, 24-5, 115, 123-5, 127, 145, 154, Figs 99-100, 102-3, 105-6, 115-17  
Building 53 15, 18, 20, 22, 24-5, 115, 126, 145, 153, Figs 99-100, 102-3, 105-6, 108, 119, 143  
Building 54 18, 26, 28, 127-8, 135, Fig 102, 104-6, 120  
Building 55 18-19, 22, 26, 28, 127-8, 135, Fig 102, 104-6, 120, App 8  
Building 56 18, 20, 23, 26, 28, 127-8, 135, Fig 102, 104-6, 120  
Building 57 18, 26, 28, 127-30, 135, Fig 102, 104-6, 120  
Building 58 18, 127-30, 138, Fig 102, 104-6, 120, App 8  
Building 59 22, 128, 130-2, 142, 154, 162, Figs 102, 104, 121-3  
Building 60 132-4, 154, Figs 102, 104, 124-5, App 8  
Building(s) 61 115, 135, 138, 140, Figs 99, 101, 112  
Building 62 28, 135, Figs 99, 101, 126  
Building 63 28, 135, Figs 99, 101, 126  
Building 64 28, 135, 138, 142, Figs 102, 104, 126-7  
Building 65 18, 23, 26, 28, 113, 115, 135, 138, 142, Figs 102, 104, 126-7, App 8  
Building 66 22, 146, Figs 135-6, Sx82
- Balmaclellan, Dumfries and Galloway Region 46
- Barley, see Cereals
- Barrels, for mixing mortar or plaster 203
- Basilicas 22, 24, 25
- Bassett, S R 82
- Bastions (medieval) 16, 17, 30, 84
- Baths 146  
see also Middleborough Building 71
- Battle Abbey, East Sussex 213
- Beckfoot, Cumbria 47
- Bed 40, 42, 44-7, Figs 32-4
- Bignor, West Sussex 168
- Blake, B 153
- Blyth, J 5
- ?Boilers (Roman) 26, 54, 176
- Bone-working 113
- Bonfire (Roman) 164
- Boudican revolt 9, 73, 103, 105-6
- Boxmoor, Hertfordshire 42, 181
- Bradwell-on-Sea, Essex 19
- Braintree, Essex 194
- Braughing, Hertfordshire 299-300
- Bricks (Roman) 24, 110, App 5  
(medieval and later) 80-2, 84, 88, 190, 194-5, 202-3, 205, 208-9
- Brixworth, Northamptonshire 361-2
- Brooches, cruciform 19
- Brussels, Belgium 153
- Building materials 20, 28-9
- Building methods 20-24, 30
- Burials, animal (Roman) 62, 66, 138  
human (Roman) 11, 16-18, 26, 40, 47, 119, 135, 142-5, Fig 110, Apps 1-2  
(post-Roman) 77, 144, 155, 183, 186, App 1
- Burton Fleming, Humberside 46
- Butt Road site 25-6
- Caerleon, Gwent 3, 34, Fig 5
- Camulodunum (Sheepen), Colchester 102
- Canterbury, Kent 213
- Caracalla, edict of 20
- Carthage, Africa (Tunisia) 57, 60
- Castle, Colchester 26, 188, 211, 213
- Castle Park site 25
- Cattle Market 189, 209
- Cellars (Roman) 20, 23, 47, 49, 52, 66, 68-70, 113, 128, 135, 142  
(post-medieval) 77, 82, 195
- Cemeteries 18, 26
- Cereals 105, 108, 110, App 11
- Cess-pits (Roman) 63, 68  
(medieval and later) 77
- Chalkwell, Kent 252
- Charcoal samples App 15
- Chelmsford, Essex 211, 213, 317
- Chester, Cheshire 34
- Childwell, see Wells (medieval)
- Chimney coping 29, 200, 202, Fig 188
- Chimneys 29-30, 81-2, 189, 195, 200, 202-3, 207-9
- Chiswell, see Wells (medieval)
- Chiswell Meadow 27
- Christchurch Castle, Hampshire 202
- ?Christian reuse of Romano-Celtic temple 125
- Chute 135
- Church, see Basilica
- Church Lane site 3, 5
- Cirencester, Gloucestershire 42, 60, 181
- Claudius I 8
- Coffin, lead, see Burials, human (Roman)
- Coins, Roman  
as dating evidence at Balcerne Lane 115, 119, 123, 125, 128, 132, 134-5, 138, 140-1, 146  
as dating evidence at Lion Walk 52, 54, 56, 62-3, 66, 69-70, 73  
medieval and later  
as dating evidence at Lion Walk 75  
as dating evidence at Middleborough 190, 195, 199, 205  
from Duncan's Gate 18-19  
Flavian-Trajanic 11, Fig 7  
site histograms 17-18, Fig 10
- Colchester Public Library 27, 73
- Colchester Waterworks site 146
- Cole, W 27
- Cologne, West Germany 10, 149
- Colony, pre-Boudican 3, 5-9, 37-41, 102-3, Figs 4, 23-5, 90-1  
defences (lack of) 8-9, 11  
see also Balcerne Lane Buildings 38-46, and Lion Walk Buildings 3-6, 8-10
- Columns 163, App 3
- Corbridge, Northumberland 46, 102
- Corduroy, timber 31, 93, Figs 18-19
- Corridor, see Passage
- Courtyard 159
- Courtyard houses 25, 52, 62, 159  
see Lion Walk Buildings 19-20, Middleborough Building 70
- Cremations 62
- Crouch Street site 11
- Crucibles 52, App 7
- Culver Street 77
- Culver Street site 3, 5, 8, 22, 211, Fig 4
- Cuma, Italy 153
- Cups Hotel site 3, 23, 29
- Cusick, Dr G E 46
- Darcy, Lady 82
- 'Dark earth' 92
- Dates, burnt 40, Fig 26
- decumanus maximus* 3, 8
- 'Daub', definition of 20  
keyed (Roman) 23, 40, 159, Fig 13

- Defences 3, 8, 11, 14-19, 26, 30, 70-3, 84, 92-3, 105, 107, 110-111, 113, 115, 117, 121-3, 126, 130, 135, 138, 140, 142, 144-6, 153, 155, 165 Figs 6-9, 40, 42, 56-7, 97-8, 102-6, 133, Sxs 54/62/55, 63, 65-6, 75, App 10  
11th-century town ditch 84, 91  
see also Bastions, Fort defences, and Fortress defences
- Diocletian, edict of 47
- Ditch 69, 108, 113, 121, 135, 138, 142  
for defensive ditches see Defences, Fort defences, and Fortress defences
- Doorways (Roman) 63, 66, 106, 108, 159, 166  
(medieval and later) 75, 77, 80, 205
- Drains (Roman) 15, 30, 36, 40-1, 47, 50, 52, 54, 63, 66, 73, 113, 117, 132, 135, 138, 158, 177, Figs 102, 104-6, 120, 127  
(medieval and later) 189-90, 194-5, App 14
- Duncan's Gate 16, 18-19, 30, 111
- Dunnett, Miss B R K 3, 5, 8, 11, 14, 110
- Dürrenberg 46
- Egg shells 50
- Einkorn, see Cereals
- Eld Lane 82, 91-2
- Elst, Holland 181
- Ely, Cambridgeshire 213
- Emmer, see Cereals
- Emona, Yugoslavia 10-11
- Executions, display of corpses 5, 93-8, Figs 85-6
- Exeter, Devon 9
- Extra-mural buildings 11, 15  
see also Balkerne Lane site, Middleborough site, and Suburbs
- Façades 205, 208
- Fashemski, Professor S A 140
- Fences 113, 121, 128, 138, 141-2
- Fentress, E W B 10
- Fields (post-Roman) 153
- Figurine, see Mercury
- Finch, R 27
- Fireback 29, 194-5, Fig 181
- Fireplaces 81, 82
- Fishbourne, West Sussex 9, 172
- Fishwick, Dr 8
- Flints, prehistoric 31
- Floors, brick (post-medieval) 82, 189, 195, 205  
daub (Roman) 3, 23, 35, 54, 56, 62-3, 66, 103, 108, 111, 119, 135, 158, 162, 164-6, 180  
(medieval and later) 30, 80, 82, 84, 189, 194-5, 199, 201-2  
gravel (Roman) 56, 135  
(medieval and later) 82  
mortar (Roman) 23, 52, 63, 66, 68-9, 132, 159, 165-66  
mosaic (Roman) 24-5, 50, 52, 54, 56-62, 69, 128, 131, 162, 165-74, 176, 179-80, Figs 46-9, 156-62  
paved (Roman) 23, 62  
sand (Roman) 3, 23, 35, 69  
sunken (Anglo-Saxon) 73  
tessellated (Roman) 24-5, 52, 54, 56, 62-3, 66, 69, 75, 165-6, 174, 176, 180  
tiled (medieval and later) 80  
timber (Roman) 3, 23, 66, 68, 119, 128, 135, 155  
(Anglo-Saxon) 73  
(post-medieval) 30, 81, 189, 195, 205, 207-8  
see also Sub-floors
- Flue 69
- Footways (Roman) 28, 62-3, 66, 68-9, 121-2, 127-8
- Fort (Roman) 5, Figs 4-5
- Fortress (Roman) 3-5, 31, 93, Figs 4-5a  
annexe 3, 5, 8, 31, Figs 4-5  
buildings 3, 5, 8, 20, 22, 25, 31-7, 40  
see also Balkerne Lane, Buildings 34-38, Lion Walk, Buildings 1-7  
conversion to colony 5, 9, 25, 37, 40  
defences 3, 8-9, 22, 31, 37, 47, 49, 93-5, 97, 101-3, 105, 110-1, 115, 135, Figs 15-16, 18-19, 80-1, 85, Sxs 65, 75  
evacuation 8, 93  
extra-mural buildings 93  
see also Balkerne Lane Buildings 34-8  
gates 5, 8, 93, 111, 122, 126  
metal-working outside 93  
see also annexe  
plan 3, 5, Figs 4-5a  
reuse of buildings, see conversion to colony  
streets 3, 5, 8, 31, 36-7, 93-4, 99, 101-3, 105, 107, 110, 115, 122, Figs 4-5a, 15, 17, 22, 80-1, Sx 61  
water supply 5, 26
- Foundations, types of 20
- Frere, Professor S S 10
- Frinton, Essex 253
- Furnaces 36, 49, 52, 69  
see also Hearths and Ovens
- Gardens, (Roman) 17, 50, 54, 56, 113  
(medieval and later) 77, 82, 92, 209  
see also Allotments
- Gates, see Balkerne Gate, Duncan's Gate, Fortress gates, Head Gate, North Gate, Rye Gate, Scheregate, South Gate
- Gerumsberg, Sweden 46
- Gilberd School site 3
- Glass, vessels 153  
window 24
- Gloucester, Gloucestershire 9
- Grain, see Cereals
- Great Easton, Essex 211, 213
- Gridirons (Roman) 1, 34, 101
- Ground-plates (Roman) 22, 31, 37, 40, 47, 50, 62, 105, 119, 127-8, 131-2, 135, 155, 158-9, 176, 180  
(medieval and later) 30, 80, 82, 84, 189, 201
- Gypsum App 2
- Hallstatt, Austria 46
- Harwich, Essex 81, 253
- Head Gate 16, 113
- Hearths (Roman) 25-6, 31, 35, 49-50, 52, 54, 56, 63, 69, 101-2, 107-10, 119, 128-30, 134-5, 138, 155, 158-9, 164-5  
(medieval and later) 77, 189-90, 194-5, 199-202, 207-8
- Head Street site 3
- Herculaneum, Italy 47
- High Street 75
- Holborough, Kent 47, 254
- Hull, MR 8, 14, 18-19, 70
- Human bone, see Burials and Executions
- Hypocausts 54, 56, 69, 176-7, 179
- Insula* 6 28  
9A 25  
10 5, 25, 28  
12 5  
14 11  
20 5  
28 69  
29 28, 70  
30 8, 25  
34 28  
35 28, 73  
36 28, 50, 73  
37 25, 28, 73  
38A 25, 28
- Joints, in carpentry, used for dating at Middleborough 207-8
- 'Jumbo' 28
- Kynsham, Avon 168
- Kilns 25  
see Pottery kilns, and Lime production
- Kitchens (Roman) 26, 50, 54, 56  
see also 'Oyster layers' (medieval and later) 194
- Latrines 190, 194, App 14
- Lavatory 63
- Laver, Dr H 121, 128, 131
- Leicester, Leicestershire 153
- Lexden Springs 28
- Lime production (medieval and later) 30, 87-91, Figs 59-61, 73-8, Sxs 43, 61
- Lincoln, Lincolnshire 9, 28
- Lion Walk 91-2
- Lion Walk site 31-92
- Roman buildings:  
Building 1 8, 31, 34, 37, Figs 15, 17  
Building 2 31, 34, 37, Figs 15, 17  
Building 3 25, 31, 34-5, 37, Figs 15, 17, 23, 25  
Building 4 31, 35, 37, 50, 75, Figs 15, 17, 23, 25  
Building 5 31, 35, 37, 50, 75, Figs 15, 17, 20, 23, 25  
Building 6 31, 35, 37, Figs 15, 17, 23, 25  
Building 7 8, 34-7, 50, Figs 15, 17, 21, 31  
Building 8 9, 22-3, 37, 40-7, 62, 132, Figs 11, 21, 23, 25, 27-31, App 6  
Building 9 8, 47, 49, 52, Figs 23-4  
Building 10 22, 49, Figs 23-4  
Building 11 49-50, Figs 22, 35, 37-8  
Building 12 49-50, Figs 22, 35, 37  
Building 13 20, 50, 54, Figs 35, 37  
Building 14 50, 54, Figs 35, 37  
Building 15 50, 54, Figs 35, 37  
Building 16 20, 50, 52, 62, Figs 35, 37, 39  
Building 17 20, 52, Figs 35-6  
Building 18 20, 52, Figs 35-6  
Building 19 19-20, 22, 25-6, 50, 52-62, 70, 73, 92, 177, Figs 40, 42-5  
Building 20 19, 25, 28-9, 62-66, 70, 73, 75, 87, Figs 40, 42, 50-1, Apps 8-9  
Building 21 66, 70, Figs 40, 42  
Building 22 19, 20, 23, 66-8, 70, Figs 40-1, 52-3, App 8  
Building 23 52, 68-9, Figs 40-1, 54  
Building 24 19, 25, 52, 69-70, Figs 40-1  
Building 25 19, 20, 25, 52, 69-70, 87, Figs 40-1  
Building 26 69-70, Figs 40-1, Sx 61  
Building 27 8, 24, 70, Figs 40-1, Sxs 58, 61  
medieval to modern buildings:  
Building 28 29, 30, 75-82, 92, Figs 59, 61-2, 64-8  
Building 29 29, 78, 81-2, Figs 59, 61-2, 67, 70  
Building 30 29, 81-2  
Building 31 29, 82  
Building 32 29, 82  
Building 33 29, 84, Figs 59, 61, 72
- Lofts Farm, Heybridge, Essex 211
- London, Greater London 97, 361
- Longthorpe, Cambridgeshire 102
- Long Wyre Street site 5, 8, 26, 29
- Louvers 29-30, 195, App 4
- Lullingstone, Kent 252
- Lyons, France 9
- Machine stripping 1, 66, 69, 127, 132
- Magdalen Street site 29
- Maidenburgh Street site 24
- Maldon Road site 26
- Malton, North Yorkshire 181
- Manchester, Greater Manchester 93
- Manor of the More, Rickmansworth, Hertfordshire 211-13
- Marbles, decorative, see Veneers

- Martyrium 25  
Mason, E N 121  
Medieval and later houses 29-30  
  see also Lion Walk Buildings 28-33,  
  Middleborough Buildings 74-6  
Mercury, figurine of 125  
Metal-working (Roman) 5, 8, 26, 31, 35, 36,  
  37, 49, 50, 52, 69, 93, 101-2,  
  110, App 7, Figs 15, 38  
  (medieval and later) 77, 91  
  see also Furnaces, Hearths, Ovens  
Middens (Roman) 52, 127  
Middleborough site 155-209  
  Roman buildings:  
  Building 67 25, 155-8, 180-2, Figs  
  145-6, App 6  
  Building 68 155-8, Figs 145-6  
  Building 69 24-5, 155, 158-9, 163,  
  180-2, Fig 148, App 6  
  Building 70 25, 28, 155, 159-174,  
  180, 182, Figs 146, 151-62, App 6  
  Building 71 155, 164, 174-80, 182-3,  
  Figs 163-7, App 6  
  Building 72 155, 180, Fig 163  
  Building 73 155, 180, 198, Fig 153  
  medieval and later buildings:  
  Building 74 29, 155, 183, 189, Figs  
  172, 176  
  Building 75 29, 155, 189-200, 208-9,  
  Figs 144, 177-84, App 8  
  Building 76 29-30, 155, 180, 195,  
  198-208, Figs 144, 183-94, App 8  
Mile End, Colchester 188, 202  
Mill Green, Ingatestone, Essex 213  
'Mithraeum' 24, 28  
Monson's Map of Colchester 208-9,  
  Fig 191  
Morant Club 121  
Morant's Map of Colchester 154, Fig 191  
Mosaics, see Floors, mosaic  
Moulsham, Chelmsford, Essex 211, 213  
Moyes, R H 57, 166  
Multi-storey car park site 155, 209  
Naissus, Moesia (Yugoslavia) 10  
Nash Hill, Lacock, Wiltshire 213  
Neal, D S 57  
Nest 50, Fig 22  
New Market Tavern, see Middleborough  
  Building 76  
Niblett, Mrs, see Dunnett, Miss B R K  
Nicopolis, Epirus (Greece) 10  
Nîmes, France 28  
Norman Colchester 29  
North Gate 16, 18, 84, 183  
North Hill sites 3, 8-9, 11, 22, 26  
North Leigh, Oxfordshire 172  
North Street 27  
Novae, Moesia (Yugoslavia) 10, 11  
Nunn's Road site 3  
Nuts 108, 110  
Oats, see Cereals  
Oculist's stamp 134  
Oescus, Moesia (Bulgaria) 10  
*opus caementicium*, see Plinths, mortared  
*opus signinum* 54, 68, 126, 159, 165, 168,  
  176  
Ovens (Roman) 25-6, 31, 36, 50, 54, 66, 69,  
  105-7, 119, 127-30, 132-5, 138,  
  158, 164-5  
  (medieval and later) 189-90, 194-5, 200  
'Oyster layers' 123, 126-7  
Paint (Roman) 163  
Parish, Josiah 153  
Passages (Roman) 54, 56, 66, 68-9, 104,  
  108, 119, 127, 130, 132, 135, 159,  
  162-3, 166, 174, 176, 180, 182  
  (medieval and later) 190, 194-5, 200,  
  202, 205, 208  
Path (post-medieval) 81  
*pes monetalis* 5, 11, 22, 28, 121, 123, 174,  
  181  
Piers (Roman) 22, 126  
Pilaster (Roman) 162-3, 182  
Piles, wooden (Roman) 20, 22, 24, 69, 126,  
  128, 146  
*pilum* 106-7  
Pits (Roman) 18, 26, 34-7, 40, 47, 49-50,  
  52, 54, 63, 66, 68-70, 93, 99, 101,  
  105-8, 113, 119, 121, 128, 134-5,  
  138, 140, 142, 144, 155, 158, 165  
  (post-Roman) 50, 54, 68-9, 75, 77-8,  
  81-2, 84, 87, 154, 165, 195, 198,  
  201, 203, 208-9, App 14  
?Platforms 155, 183  
Plinths, mortared (Roman) 3, 20, 31, 34-7,  
  40-1, 50, 75, 119, 123, 135  
  (medieval and later) 30, 80, 84, 189,  
  194, 199-201, 205  
  rubble and daub (post-medieval) 205  
Pliny 253  
Plum, burnt 40, Fig 26  
Poetovio, Pannonia (Yugoslavia) 10  
Pompeii, Italy 28, 140, 149, 153  
Pope's Lane 154  
Portchester, Hampshire 30, 102  
Portico, see Verandah  
Postern, see Drains  
Pottery, prehistoric 31  
  Roman  
  as dating evidence at Balcerne Lane 93,  
  115, 119, 121, 123, 126, 128, 132,  
  135, 138, 140, App 10  
  as dating evidence at Lion Walk 52, 62,  
  63, 66, 68, 70, 73, App 10  
  as dating evidence at Middleborough  
  182  
  'Colchester vase' 153  
  Flavian-Trajanic 11, Fig 7  
  pots set in ground 106, 135, App 8  
  pot used as an oven 134, App 8  
  from town rampart sections 14, 15  
  votive pots 62, 66, 119, 128, 130, 135,  
  144, App 8  
  Saxon  
  as dating evidence at Balcerne Lane  
  145  
  as dating evidence at Lion Walk 75  
  medieval and later  
  as dating evidence at Lion Walk 75, 77,  
  81, 82, 84, 87, 91  
  as dating evidence at Middleborough  
  183, 186-9, 190, Fig 175  
  from C11th town ditch 84, 91  
  pots set into floors 195, App 8, App 14  
  pot set into ground 199, App 8, App 14  
  see also Louvers  
  kilns (Roman) 14, 26, 155, 182-3, Fig 144,  
  Apps 13-14  
  (medieval) 75, 155, 186-9, 202, 208-9,  
  Figs 174-5  
Poundbury, Dorset 252  
Powers, Dr R 232  
*praefurnium* 176-7  
Public buildings 8, 9, 23, 24-25, 29, 70, 111  
  see also Arch, monumental, Balcerne  
  Lane Buildings 52-3, Basilicas,  
  Martyrium, 'Mithraeum', ?Shrine,  
  Temples, Theatre  
Putlog holes 84  
Quarrying 119, 142  
Quern (post-Roman) 194  
Radiocarbon dating 207-9  
Ratiaria, Moesia (Bulgaria) 10  
Ravenna, Italy 62  
Reredos 200  
Reuse of fortresses 9-11  
Reuse of military buildings, see Fortress,  
  conversion to colony, and Reuse of  
  fortresses  
River Colne 16, 19, 123, 155, 179, 209  
Robber trenches (Roman) 123, 125-6, 145,  
  154  
  (post-Roman) 75, 77, 82, 84, 87, 91-2,  
  128, 154-5, 162, 164-6, 176-7, 180,  
  189, 194, 198, 208  
Roman River 28  
Rome, Italy 47  
Roofs (Roman) 105, 108, 166  
  (medieval and later) 78, 80, 200, 202,  
  207-8  
Rope 42, Fig 33  
Rye, East Sussex 213  
Rye Gate 30  
St John's Abbey Grounds site 26, 30, 87  
St Mary's Church 30  
St Mary's Cottage site 3  
St Mary's Hospital 144  
St Mary's Rectory site 3  
St Mary's Terrace 128, 130-1, 132  
St Nicholas' Church site 70  
?Sand quarrying, see Quarrying  
Sarmizegetusa, Dacia (Rumania) 10, 11  
Savaria, Pannonia (Hungary) 10  
Saxon raids 19  
Saxon shore forts 19  
Scheregate 30  
Scupi, Moesia (Yugoslavia) 10  
Seeds, see Cereals  
Segontium (Caernarvon), Gwynedd 102  
Septaria, definition of 20  
Sheepen 183  
Sheepen Road 174  
Sheepen site 5, 23, 26, 153, 215  
Shield boss 106-7  
Shop (modern) 82  
?Shrine 20, 22, 111, 125-6  
Siege of Colchester 84  
Silchester, Hampshire 60, 172  
Sirmium, Pannonia (Yugoslavia) 10  
Siscia, Pannonia (Yugoslavia) 10  
Skenfrith, Gwent 202  
Slate 82, 84  
Snails 241-2, App 14  
Soakaways 195  
Soil samples Apps 9, 12, 14  
Soil types 2  
Southampton, Hampshire 202  
South Gate 16  
Speed's Map of Colchester 27, 154  
Spelt, see Cereals  
Stanwell, see Wells (medieval)  
Stockwell, see Wells (medieval)  
Stoke holes 54, 57, 69, 174, 176, 182  
Stoke pits 176, 182  
Streets (Roman) 11, 18, 37, 40, 47, 52, 64,  
  66, 68-70, 73, 102-3, 105, 107,  
  110-11, 113, 115, 117, 119, 121-3,  
  126-8, 130, 135, 138, 140-2, 145-6,  
  154-5, 159, 162, 165-6, 174, 182-3,  
  208, Figs 15, 17, 22, 99, 101, 105-6,  
  144, Sxs 4, 42, 58, 61, 93  
  see also Fortress streets  
  (medieval and later) 77, 81, 91-2, 155,  
  195, 200  
Strip-houses 25, 102-3, 105, 107-8, 111,  
  117, 119, 127, 135, 155  
  see Balcerne Lane Buildings 39-42,  
  44-51, 54-8, 61, Middleborough  
  Building 67  
Sub-floors, clay-lined 179  
  *opus signinum* 176  
Suburbs 16, 18, 19, 20  
Tacitus 8, 37  
*tapete Britannicum* 47  
Telephone Exchange site 3, 5, 8  
Temples 20, 25  
  of Claudius 8, 9, 11, 20, 23, 25, 29  
  see also Balcerne Lane Buildings 52-3  
Terracotta relief 153  
Textiles 42, 44-7, 144, Fig 32-4, App 2  
Thamugadi, Numidia (Algeria) 10  
Thasos, Greece 171-2  
Theatre (Roman) 8-9, 24, Fig 9  
Theveste, Numidia (Algeria) 10  
Threshold (Roman) 63, 166  
  (post-medieval) 203  
Tile (Roman) 24-5, 54, 70, 75, 88, 91,  
  105-8, 110, 119, 123, 128-32,  
  134-5, 146, 155, 163, 165-6, 176,

- 189, App 5  
 (medieval and later) 77-8, 80-2, 84, 88, 91, 123, 190, 194-5, 199-202, 209, 213  
*tossia Britannica* 47  
 Town development (Roman) 5-9, 11-19, Figs 4, 6-9  
 Town-zone, of colony 19-20  
 Trier, West Germany 181  
 Trinity House, see Lion Walk Building 30  
 Uzitta, Tunisia 60  
 Valkenburg, Holland 102  
 Veneers, stone 28-9, App 3  
 Verandah 162, 166  
 Verulamium (St Albans), Hertfordshire 19, 46, 60, 153, 171-2, 181, 362  
 Victoria Inn site 16  
 Vienne, France 171-2  
 Vindolanda, Northumberland 46  
 Vineyards 140  
 Vineyard Street 91  
 Vitruvius 28  
 Votive deposits 62, 66, 119, 128, 130, 135, 144, App 8  
 Wadhams, M C 208  
 Walbrook, London 97  
 Walker, J 202  
 Wall plaster 23, 37, 40, 42, 47, 62-3, 70, 104-5, 119, 131, 134, 146-53, 159, 162, 166, 176, 180-2, 253, Figs 137-43, 150, 169, App 6
- Wall, town, see Defences  
 Walls, boarded (Roman) 23  
 boundary (medieval) 77, 92  
 brick (post-medieval) 189, 195, 205  
 daub (Roman) 14, 63, 66, 101, 103-4, 106-7, 119, 158, 162, 176  
 daub (post-medieval) 194, 201  
 daub-block (Roman) 22, 31, 40, 47, 49, 50, 52  
 mortared (Roman) 23  
 party- (Roman) 25, 108, 117, 119, 128, 135  
 plastered (pre-Boudican) 3, 37, 42  
 for post-Boudican plastered walls  
 see Wall plaster  
 post-in-trench (Roman) 23, 105, 108  
 stake-and-wattle (Roman) 23, 101, 104-5, 107  
 stud-and-wattle (Roman) 22, 37, 40, 104-5
- Waltham Abbey, Essex 213  
 Walton, Essex 253  
 Walton Castle, Suffolk 19  
 Warmington, 213  
 Water-mains, see Water supply  
 Water supply (Roman) 5, 26-8, 102-3, 111, 115-17, 119, 179, Figs 84, 90-1, 99, 101-4, 107-9, 140  
 (post-Roman) 26-8  
 Water-tanks (Roman) 140-2, Figs 102, 104, 106, 131
- (post-medieval) 195  
 Water-tower (Roman) 28  
 (Victorian) 28  
 Waterworks House 27  
 Weeds App 11, 12, 14  
 see also Cereals  
 Wells, timber-lined (Roman) 5, 26, 155, 182, Fig 170  
 brick-, stone-, or tile-lined (medieval and later) 26, 194-5, 209, App 14  
 West Bergholt, Essex 81, 211  
 Wheat, see Cereals  
 Wheeler, Sir Mortimer 25, 121-2  
 Wheel-ruts (Roman) 93, 99, 123, 138  
 Winchester, Hampshire 153  
 Windmill Field 27-8  
 Window (Roman) 66, 135, 159  
 (medieval and later) 75, 82, 205  
 Workshops (Roman) 50, 52, 62, 69, 102, 132-4  
 Wrabness, Essex 253  
 Wroxeter, Salop 9  
 Yards (Roman) 62, 63, 66, 69, 105, 110, 123, 128, 132, 155  
 (medieval and later) 77-8, 80-1, 190, 194-5, 200, 203  
 York, North Yorkshire 252  
 Zaragoza, Spain 10  
 Zliten, Tripolitania (Libya) 153  
 Zwammerdam, Holland 102





Fig 16 Military remains (Period 1) at Lion Walk (east). [Pages 31-7]





Fig 24 Lion Walk Period 2 (east). [Pages 37-49]









Fig 41 Lion Walk c AD 100-450 (east). [Pages 66-70]



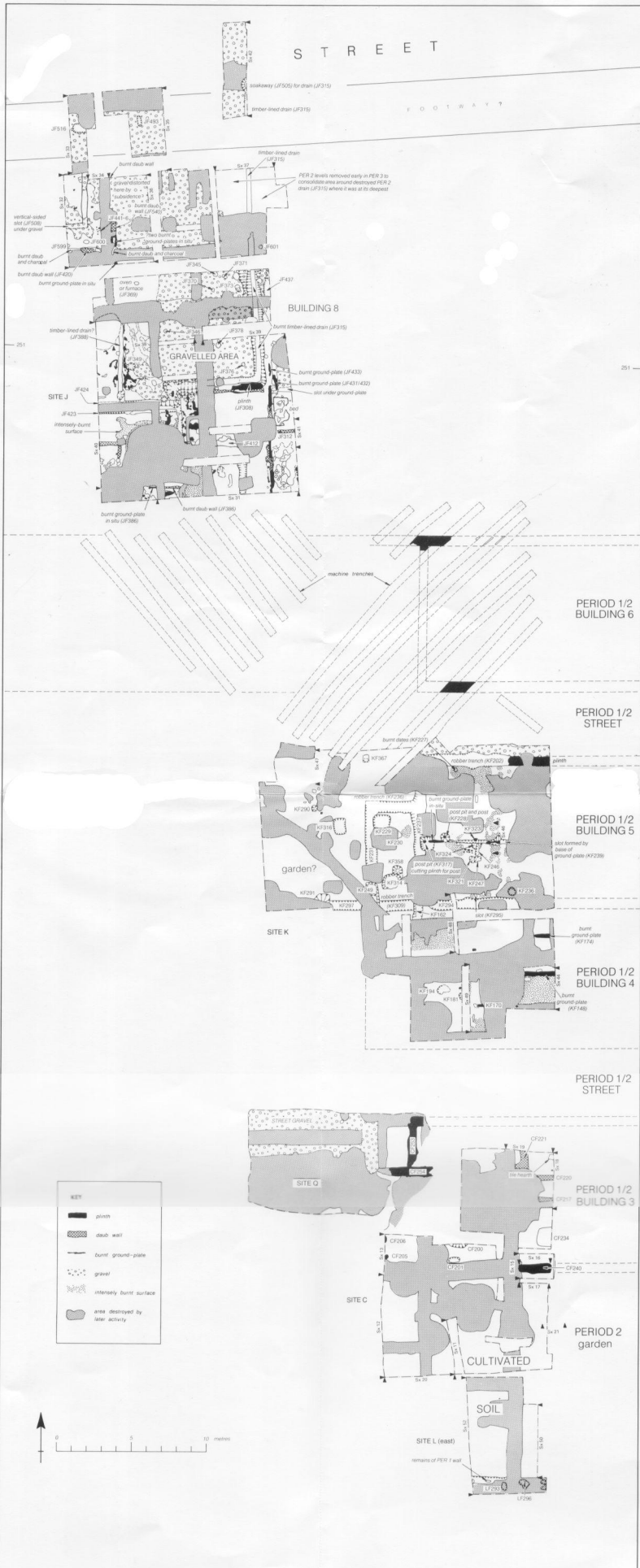


Fig 25 Lion Walk Period 2 (west). [Pages 37-47]



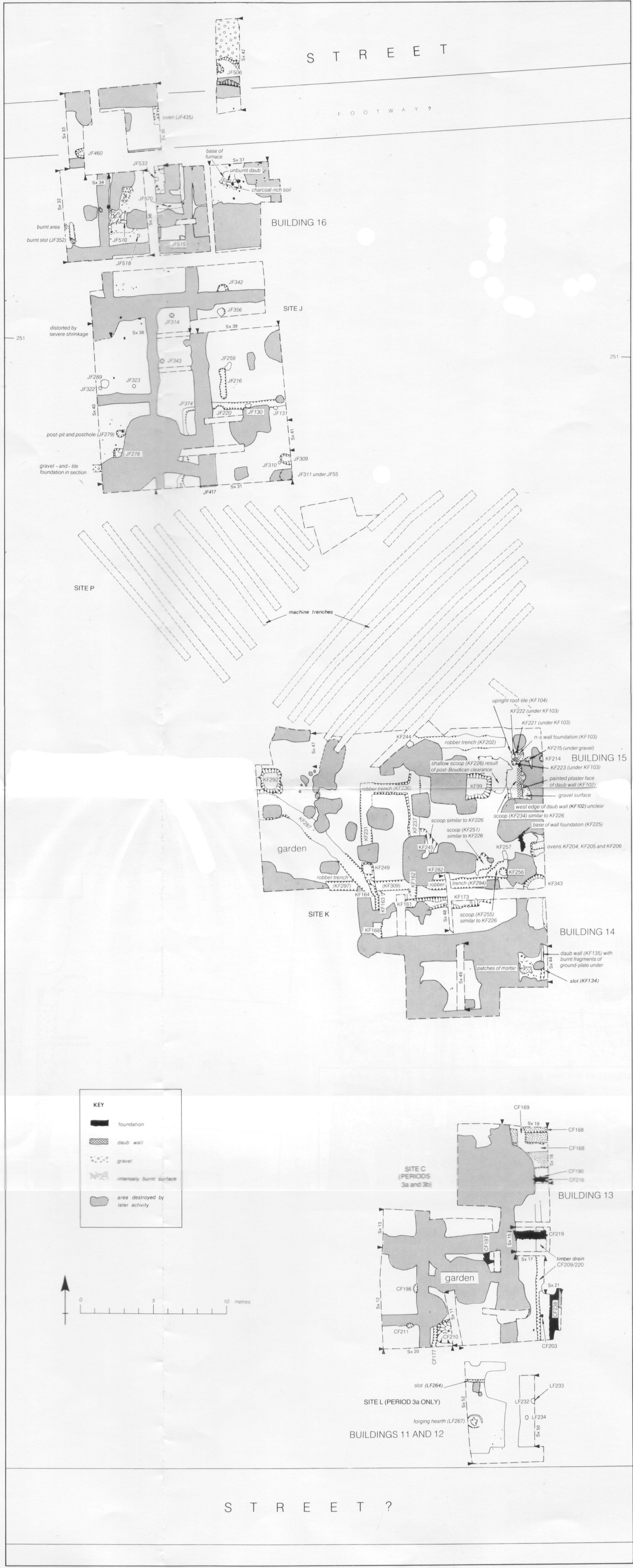


Fig 37 Lion Walk AD 60/1-c 100 (west). [Pages 49-52]



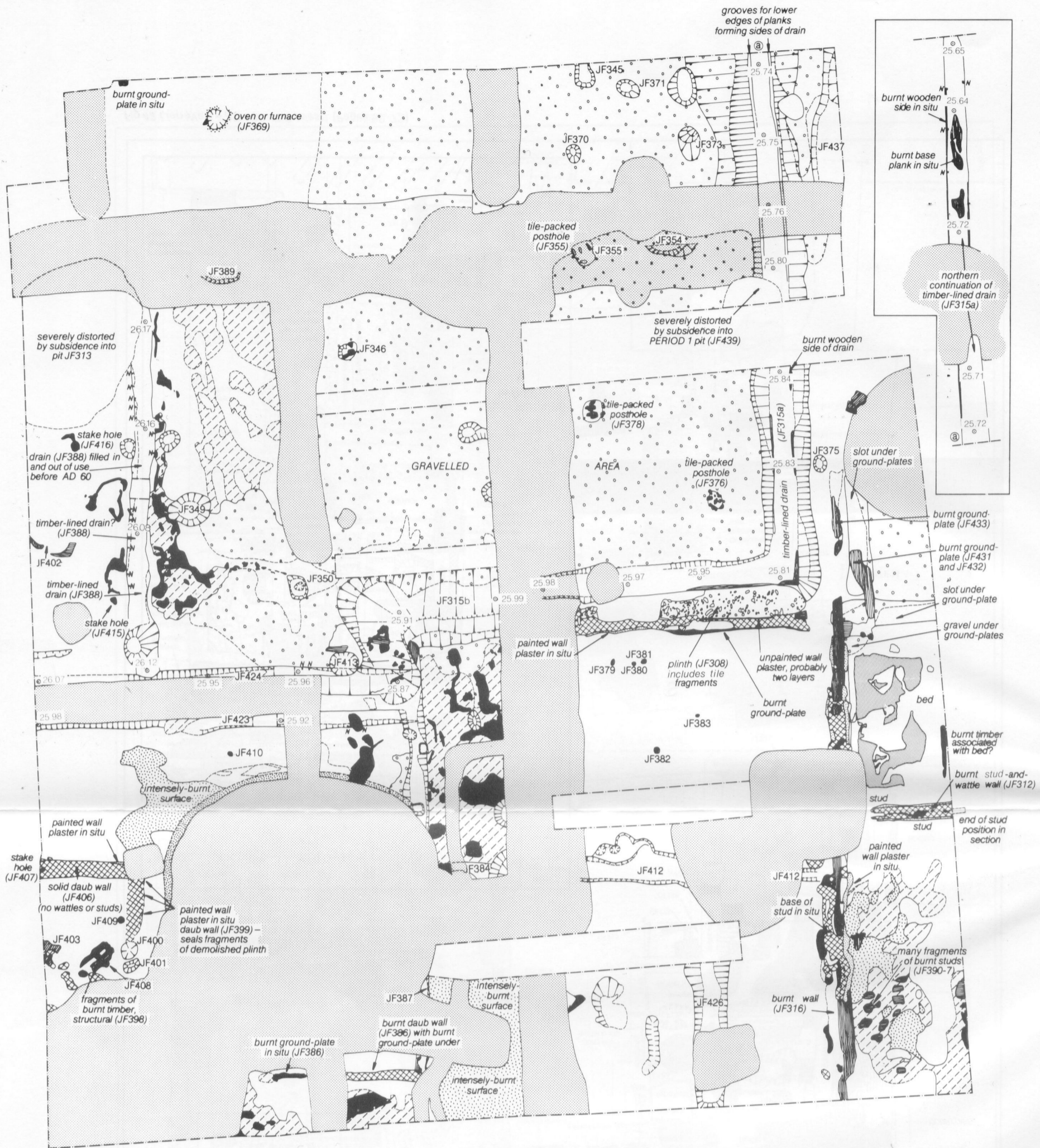


Fig 29 The southern end of Building 8 with first phase of drainage system shown separately below. 1:60. [Pages 40-2]



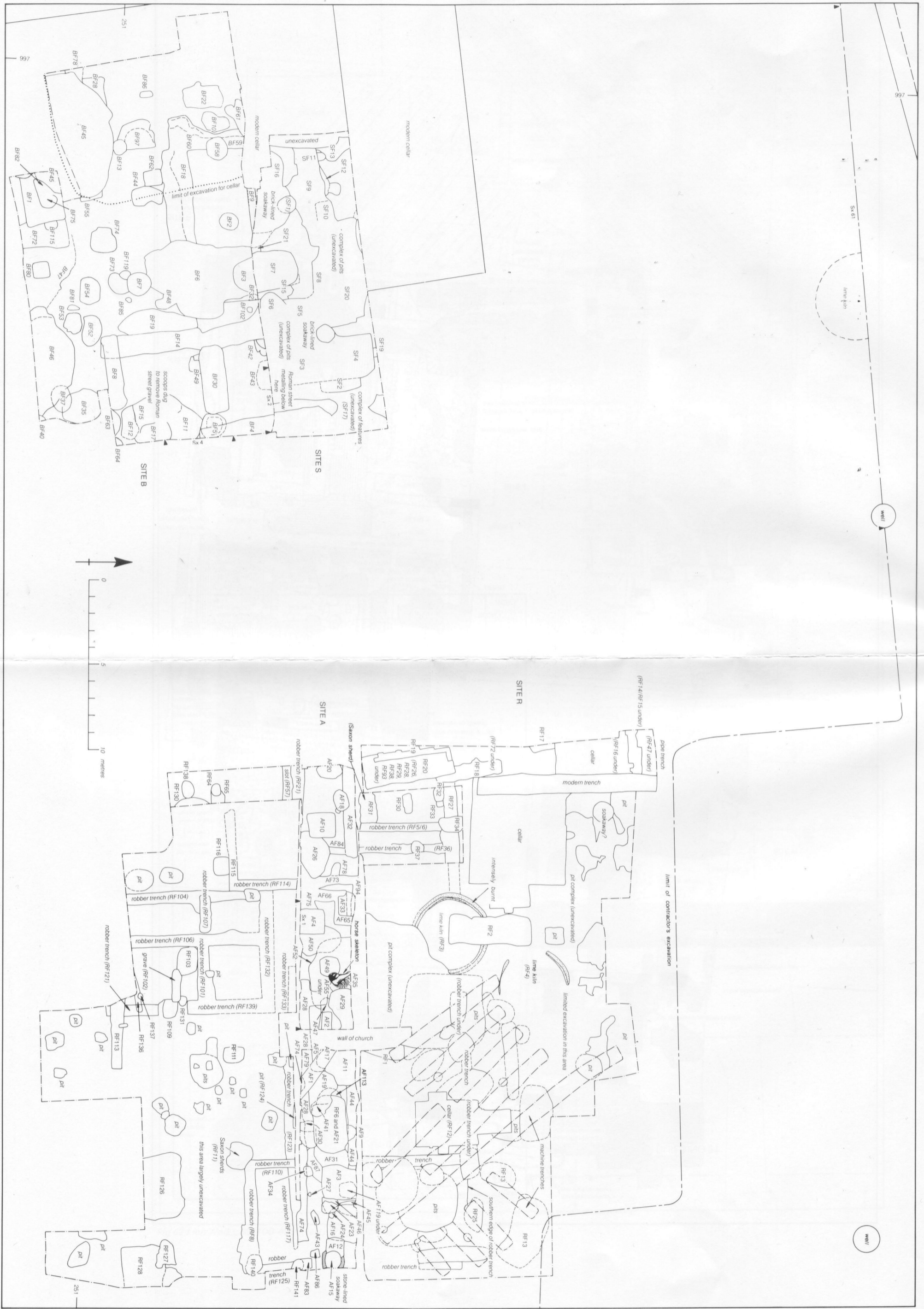


Fig 60 Lion Walk post-Roman (except Building 28, Phase 1) (east). [Pages 75-92]









Fig 67 Buildings 28 and 29 (Phases 2 and 3). 1:75. [Pages 78-81]







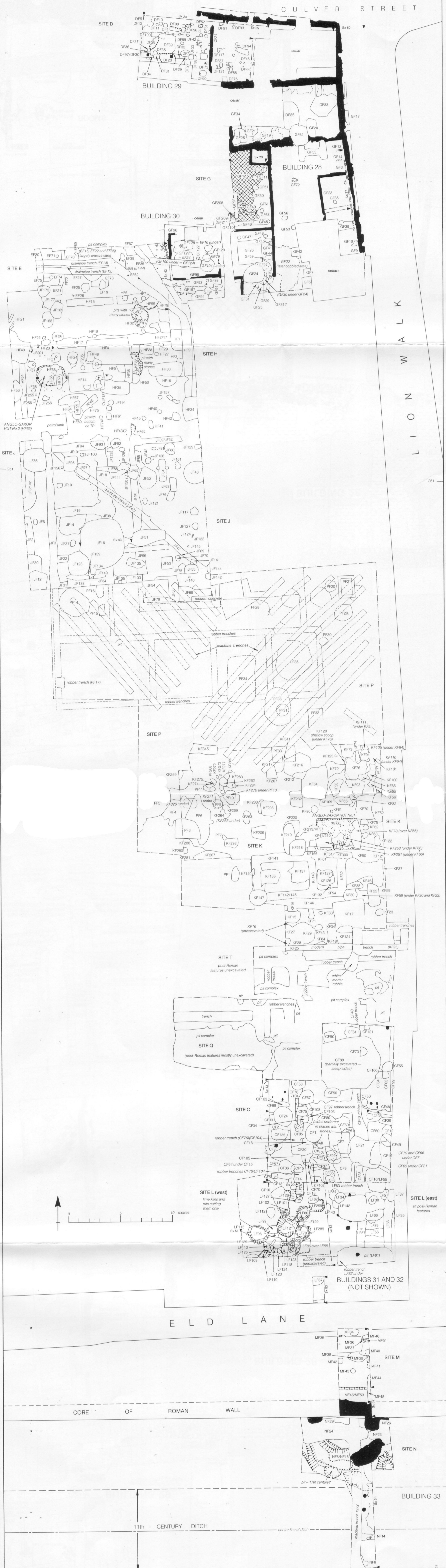


Fig 61 Lion Walk post-Roman (except Building 28, Phase 1) (west). [Pages 73-92]



INSET  
 left: features sealed by earlier street metalling  
 right: wheel ruts and decayed wattles on earlier metalling

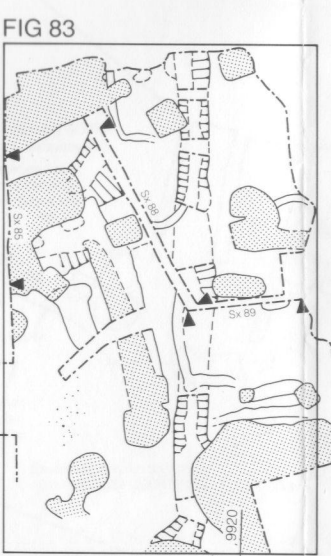
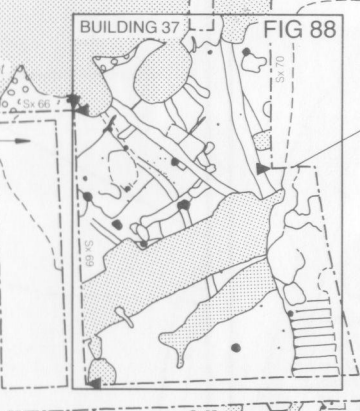
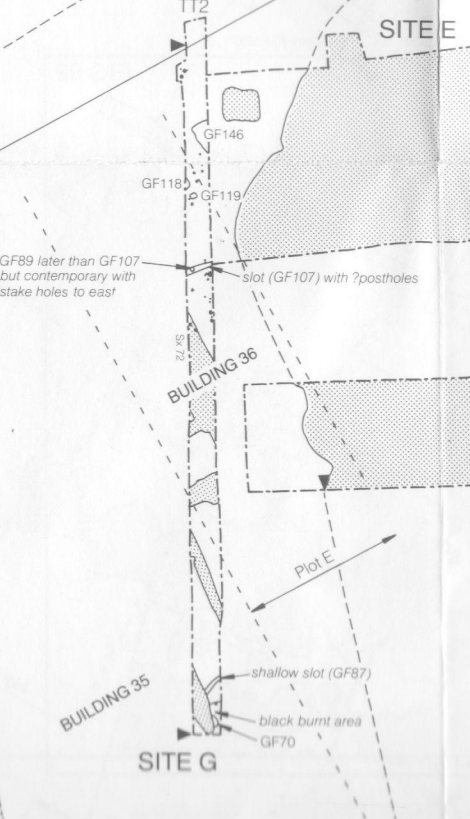
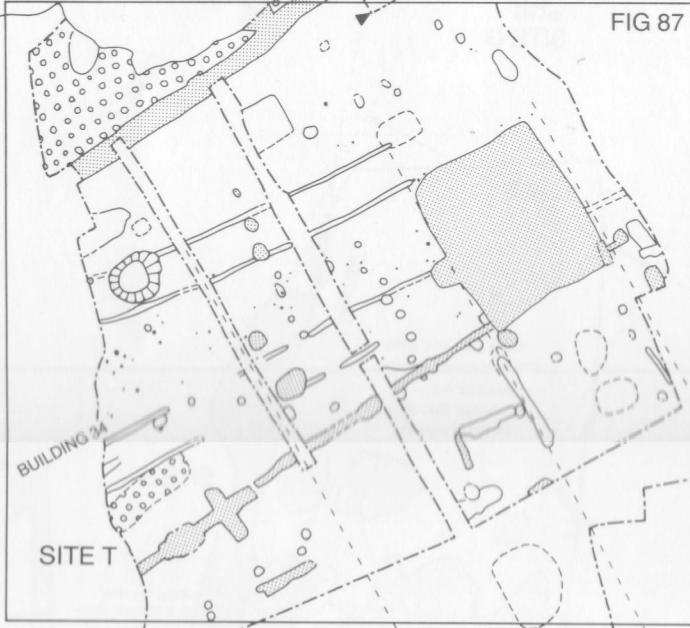
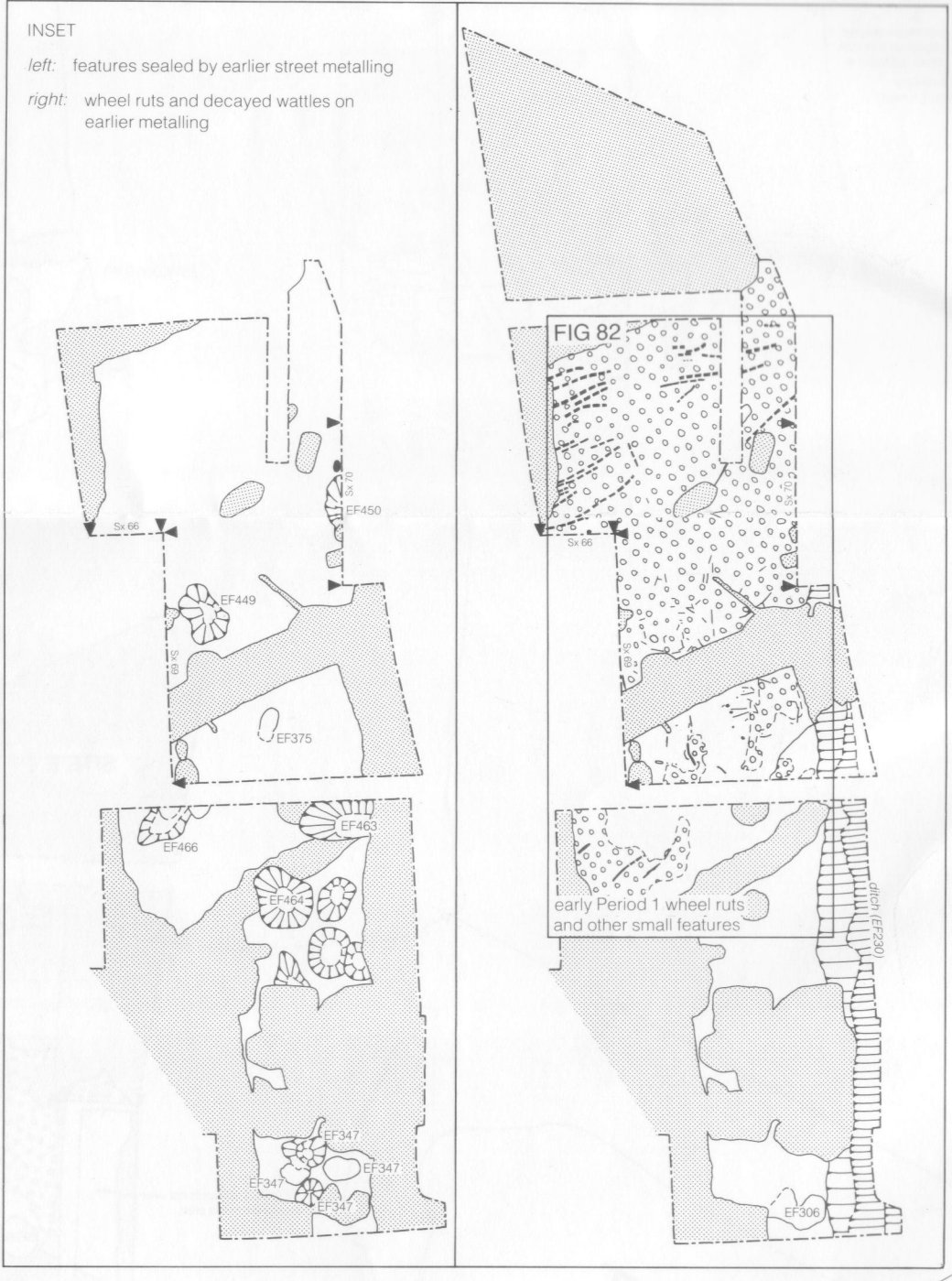


Fig 81 Balcerne Lane Period 1 (AD 43-50/55) (east and west). [Pages 93-102]





FIG 126

FIG 110

FIG 112

**INSET**

above: pre-PERIOD 4 street (all PERIOD 4 or earlier)  
 below: latest PERIOD 4 metalling and features

shallow depression with burnt sides (VF220) — probably bottom of an oven

burnt patches probably similar to VF170 bottoms of ovens (or hearths)?

burnt patch — base of oven (or hearth)?

area superficially examined

destroyed by cultivation of PERIODS 4 and/or 5

southern limit of PERIOD 4 and/or 5 destruction uncertain here

approximate limit of PERIOD 4 and/or 5 destruction

EARLIEST STREET

wheel ruts (VF115) on PERIOD 4 metalling which seals VF142

Bottoms of features survive at base of cultivated soil. Little excavation on this site. Probably mixture of features of PERIODS 2 and 4 — mainly the latter.

Fig 101 Balcerne Lane AD 60/1-150 (west). [Pages 111-2, 115-21]





Fig 91 Balcerne Lane Period 2 (east and west). [Pages 102-110]



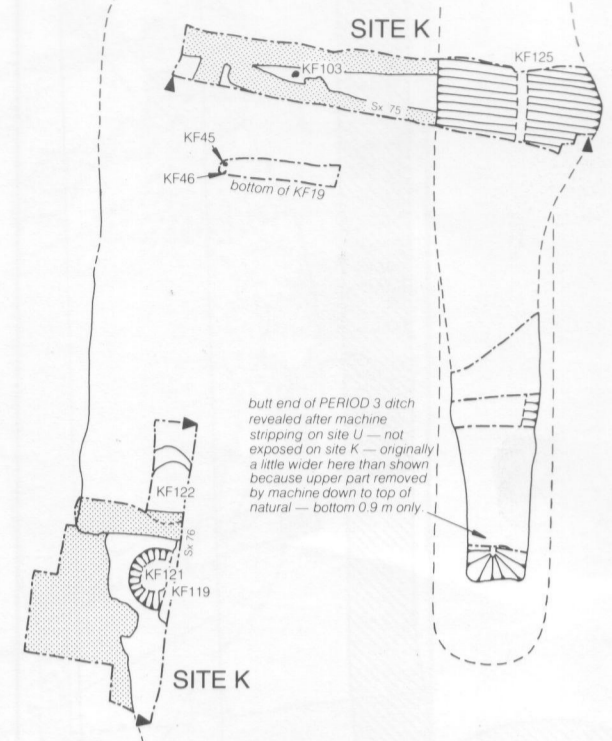
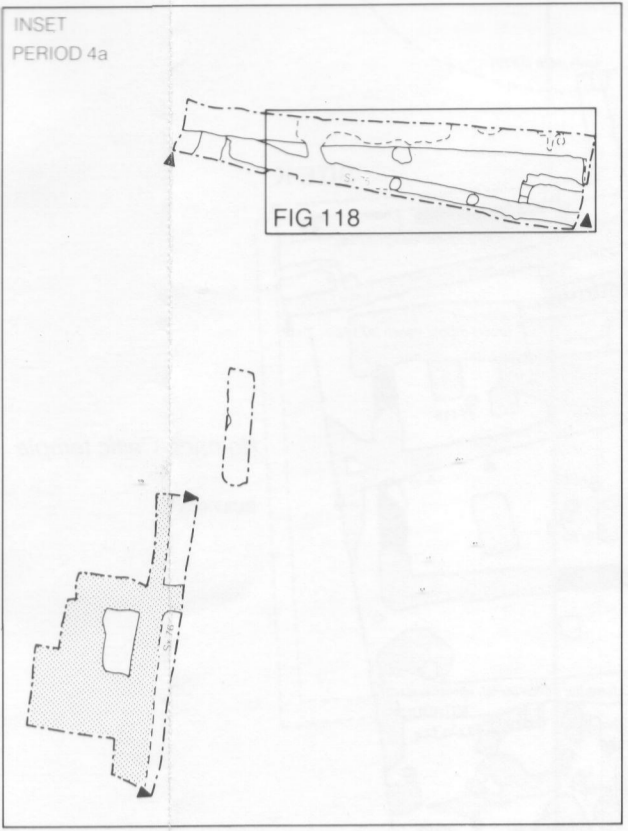


Fig 111 Building 51. 1:125. [Page 119]





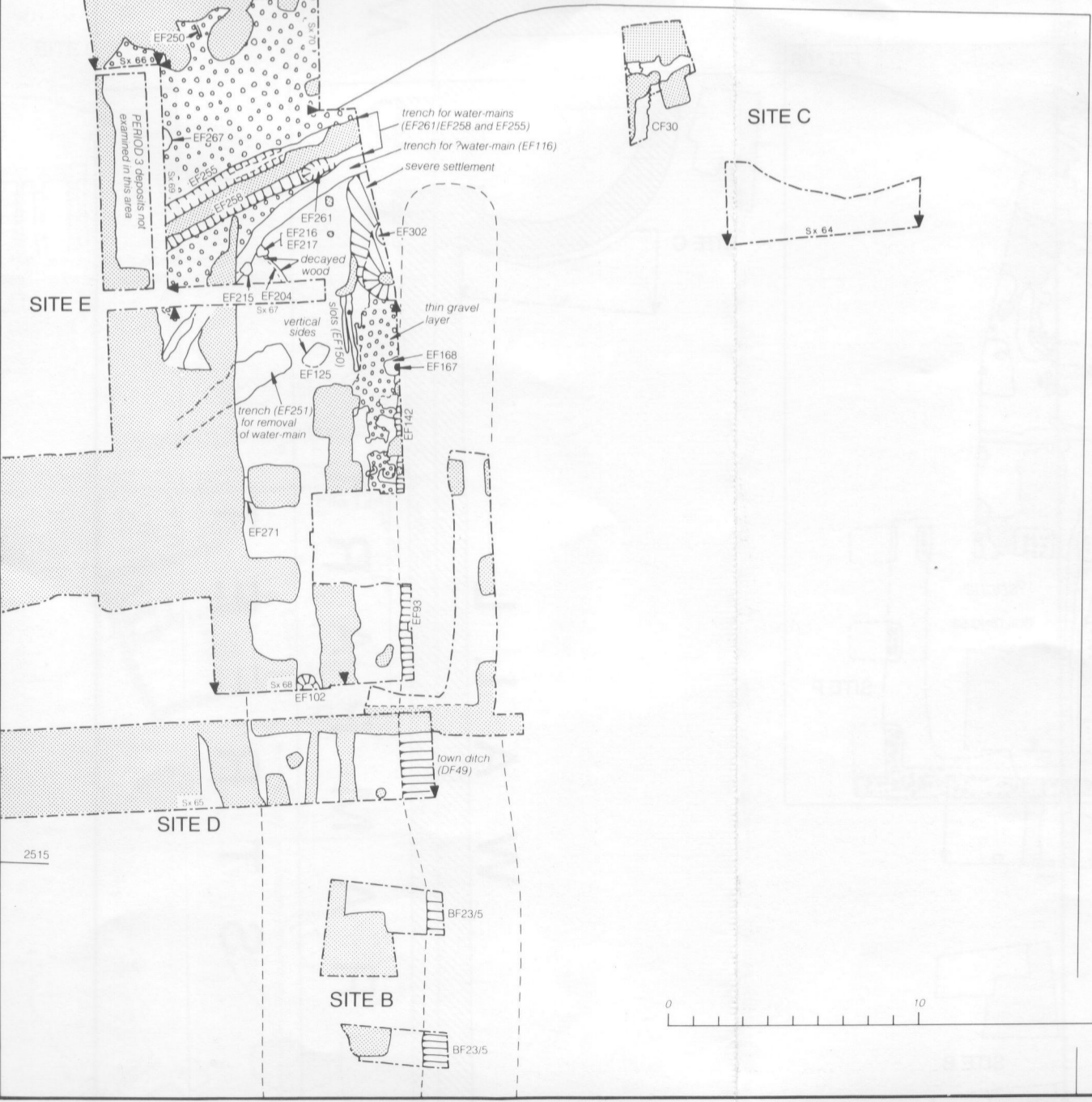




S T R E E T

2520

2520



2515

2515

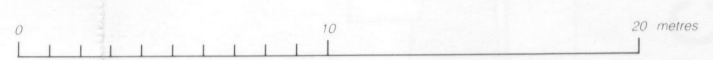
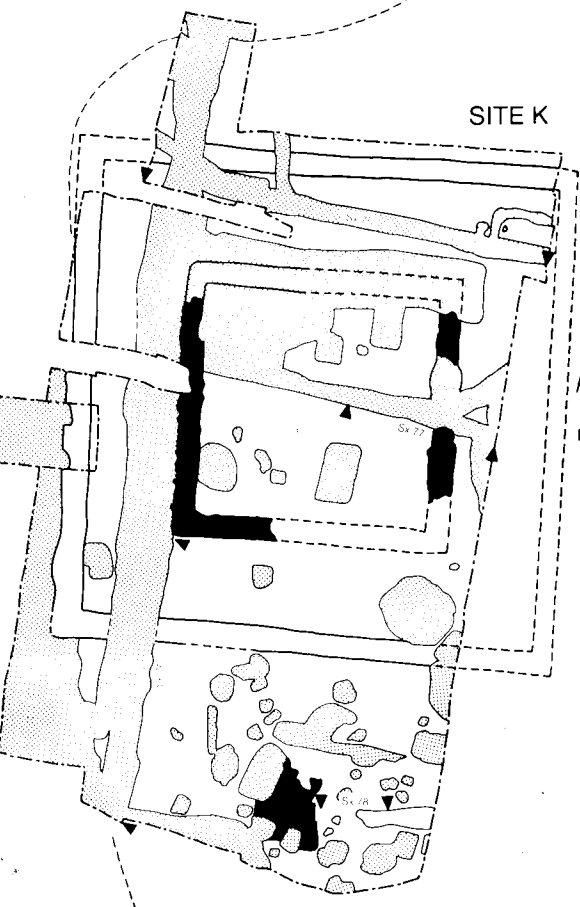


Fig 98 Balcerne Lane Period 3 (east) (AD 60/1 - c 80). [Pages 110-1 & 115]



SITE K

Romano-Celtic temple  
BUILDING 52



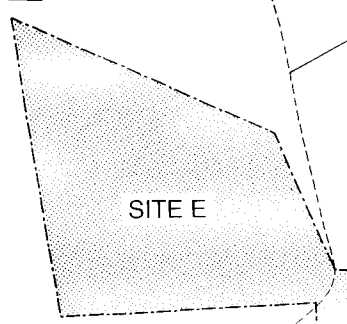
2520

2520

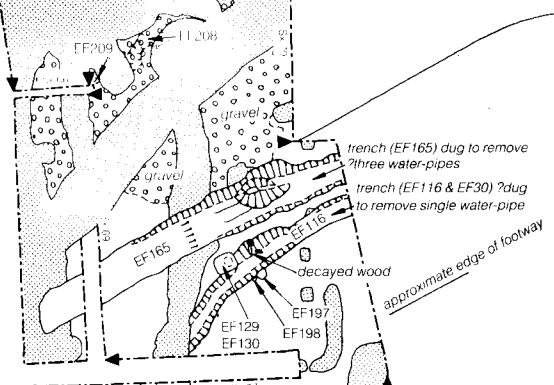
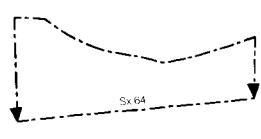
SITE E

STREET

BALKERNE GATE



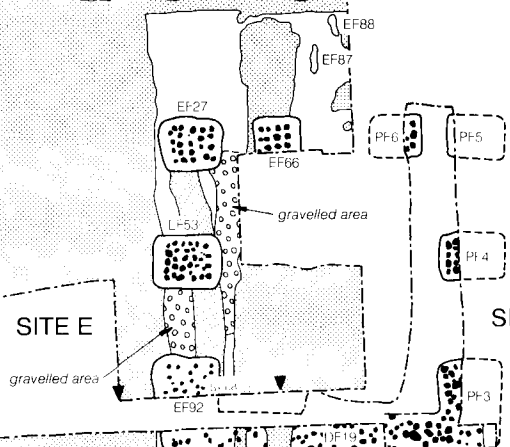
SITE C



?shrine  
BUILDING 53

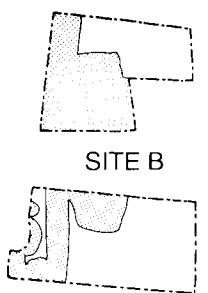
SITE E

SITE P



SITE D

SITE B



2515

2515



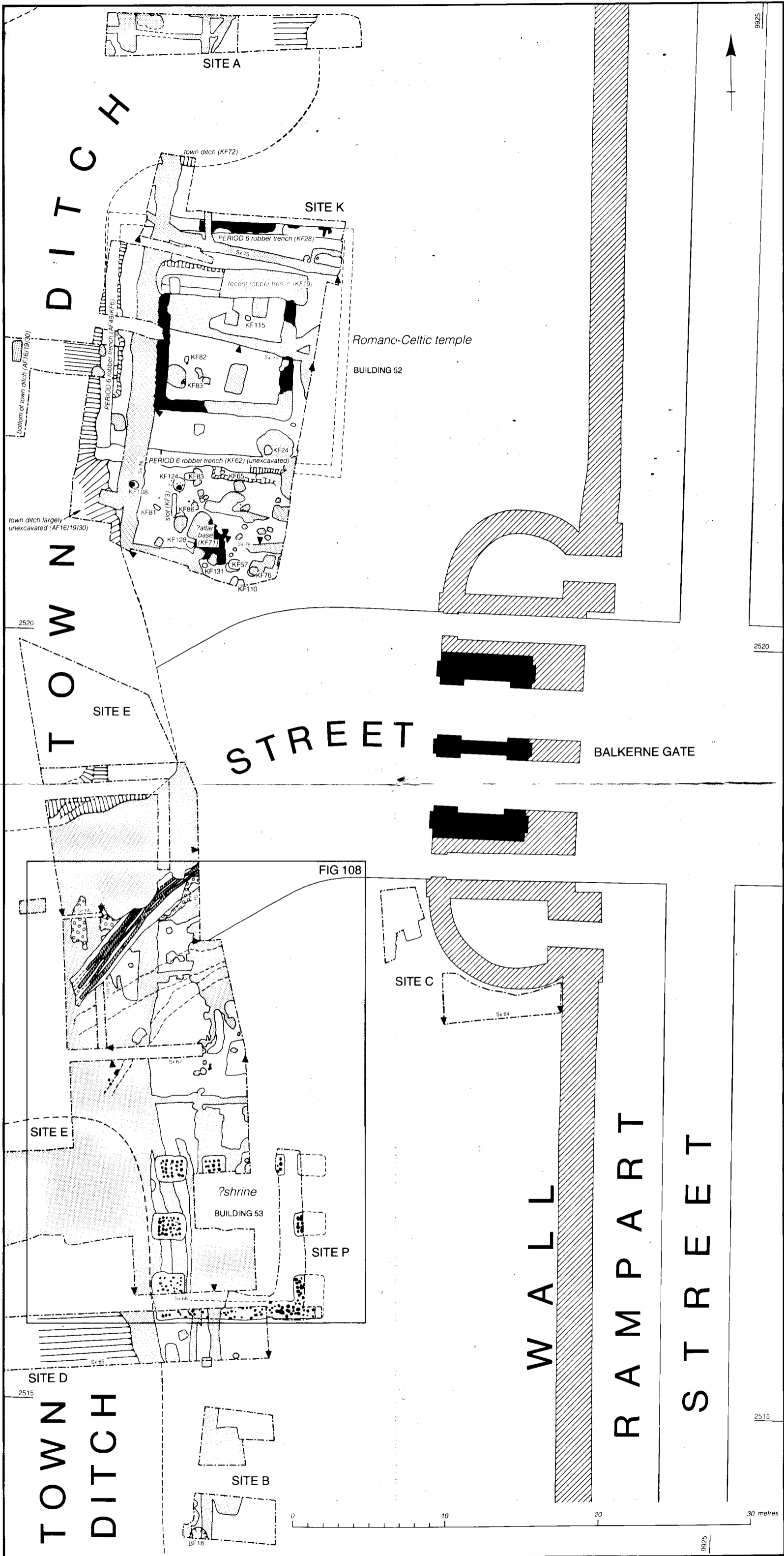


Fig 103 Balcerne Lane Period 5 (east). [Pages 111, 113, 115-7, 121-7, & 145]







FIG 127

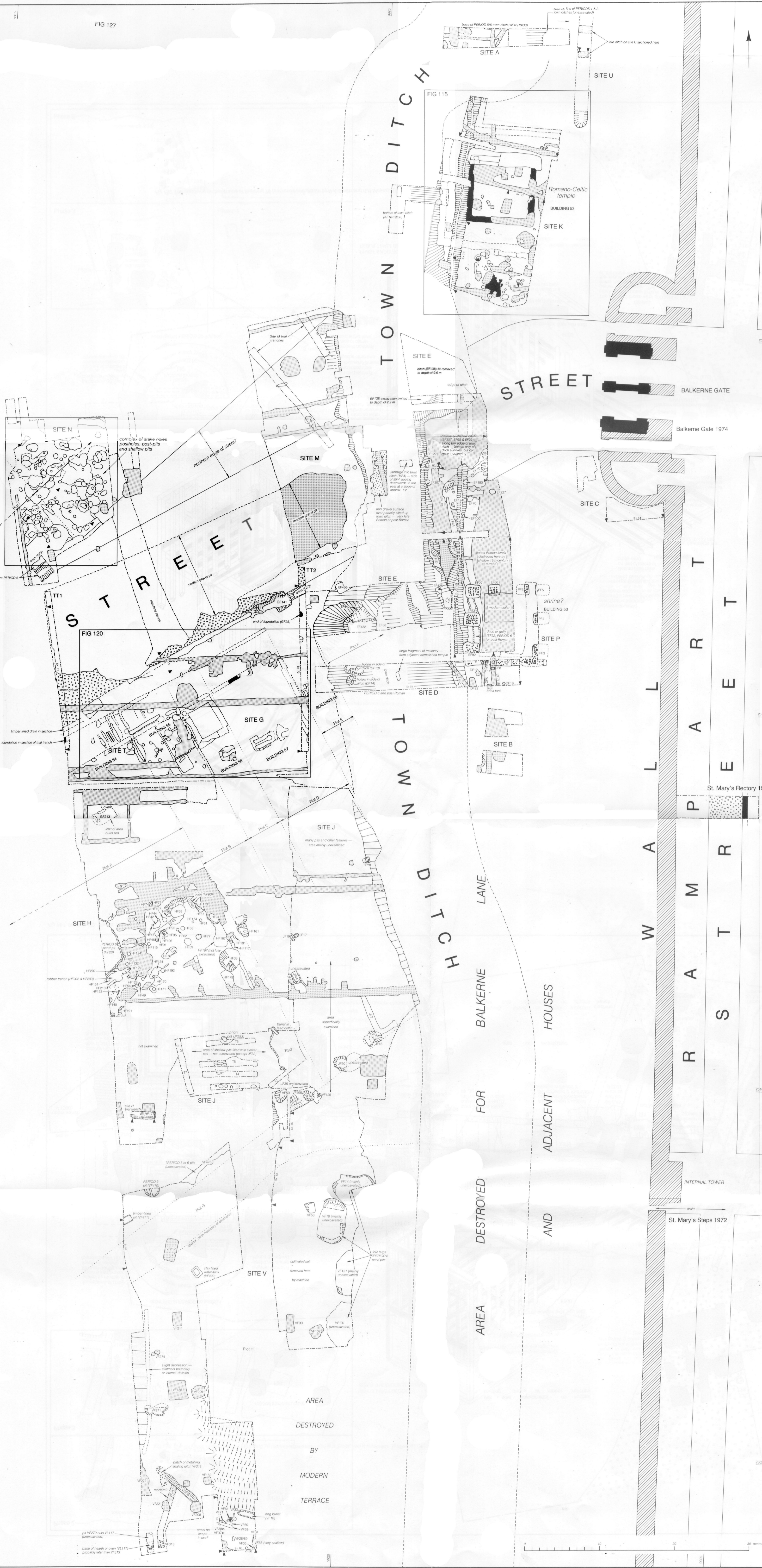
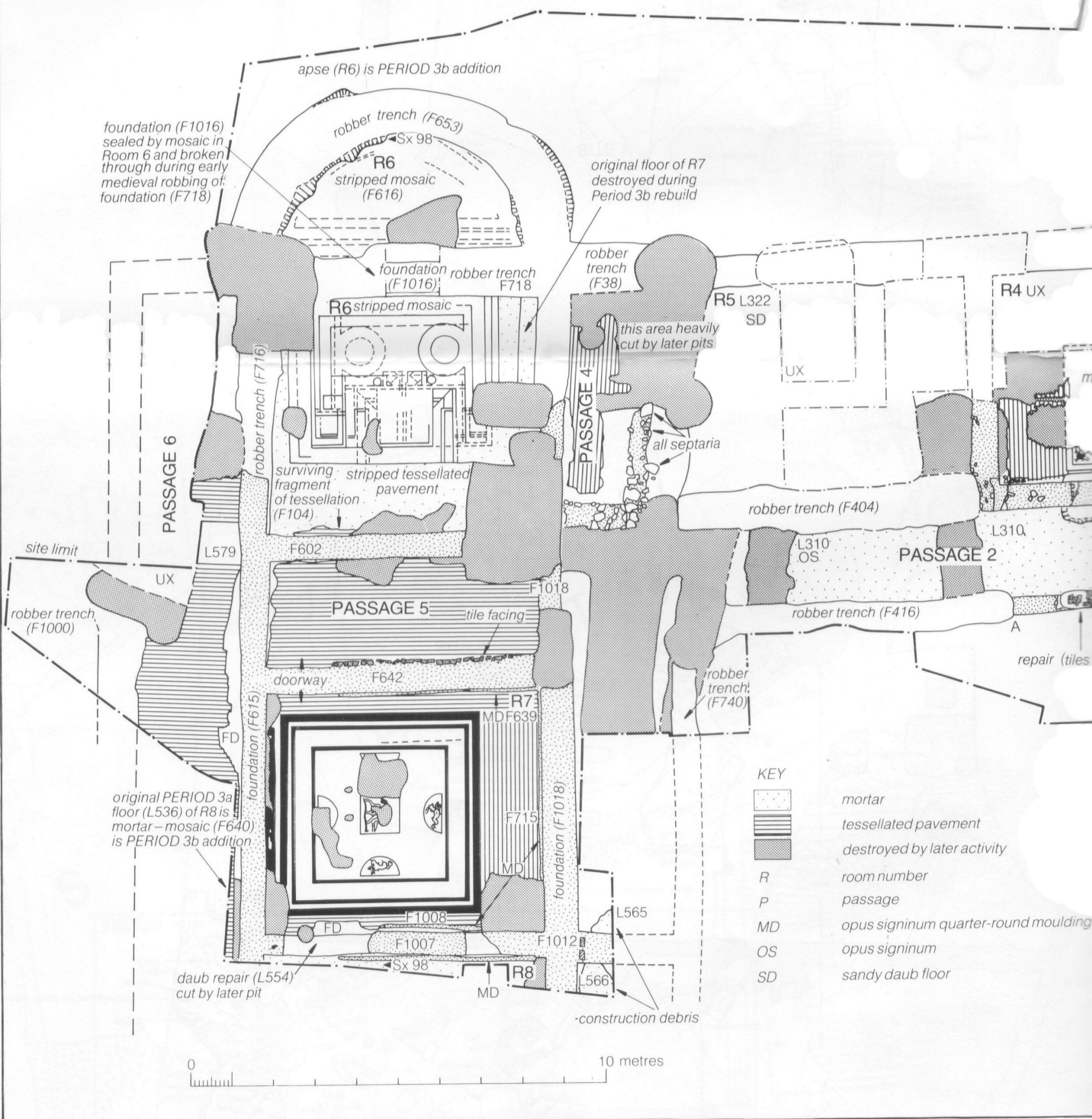
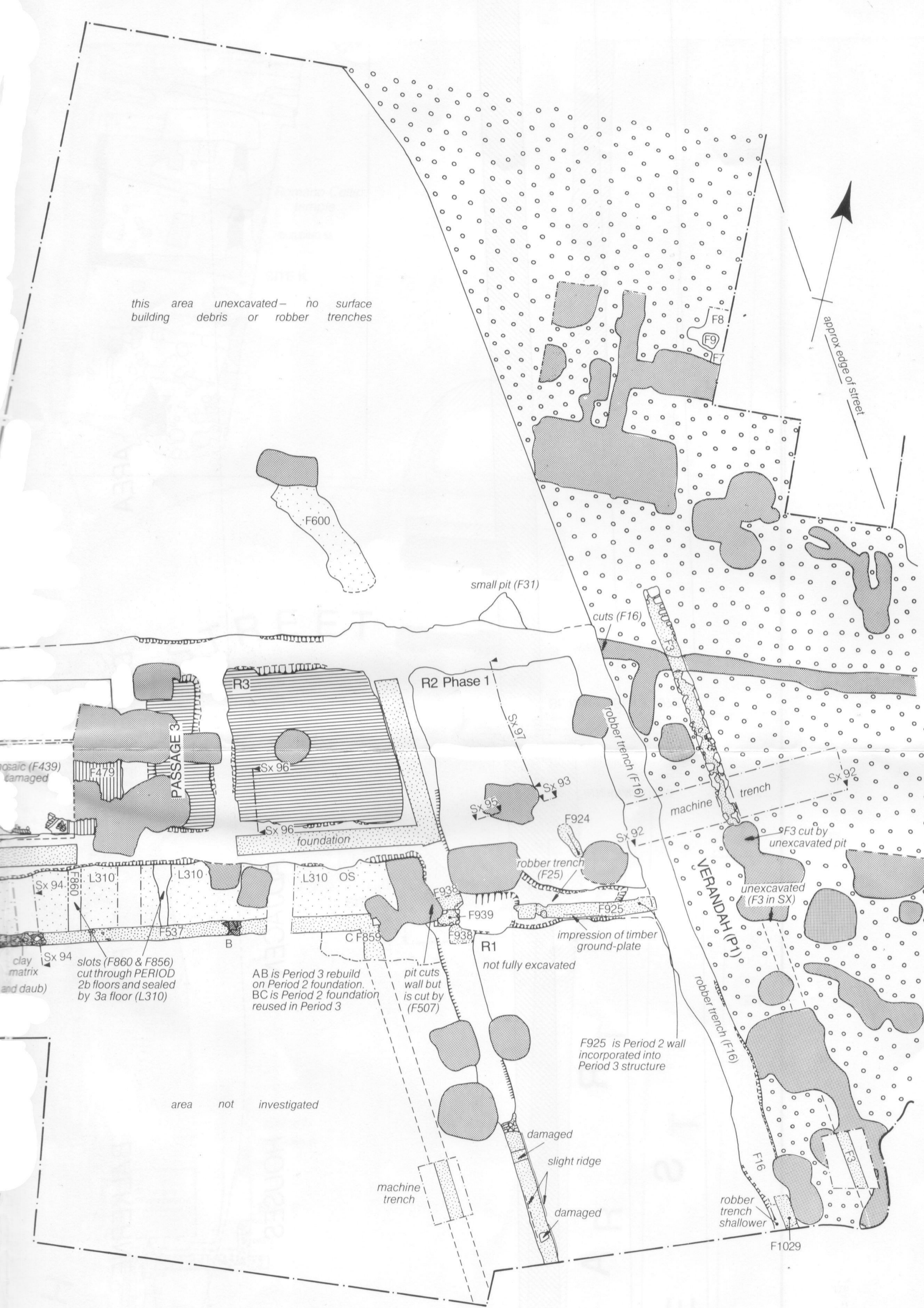
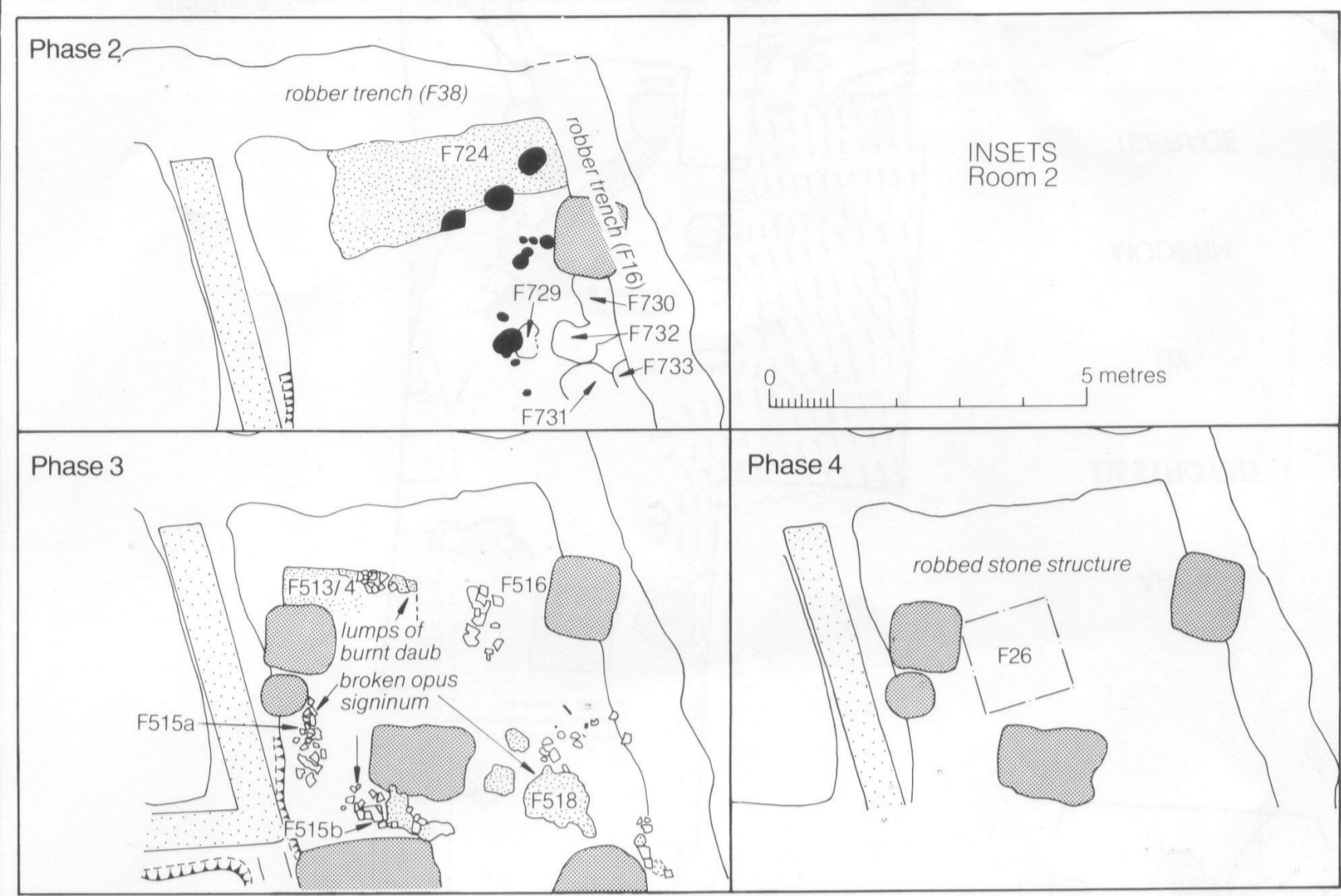


Fig 106 Balcerne Lane Periods 5c and 6 (east and west). [Pages 111, 113-7, 121-30, 137-42, 145-6]





**KEY**

	mortar
	tessellated pavement
	destroyed by later activity
<b>R</b>	room number
<b>P</b>	passage
<b>MD</b>	opus signinum quarter-round moulding
<b>OS</b>	opus signinum
<b>SD</b>	sandy daub floor

Fig 151 Building 70. [Pages 159-66]



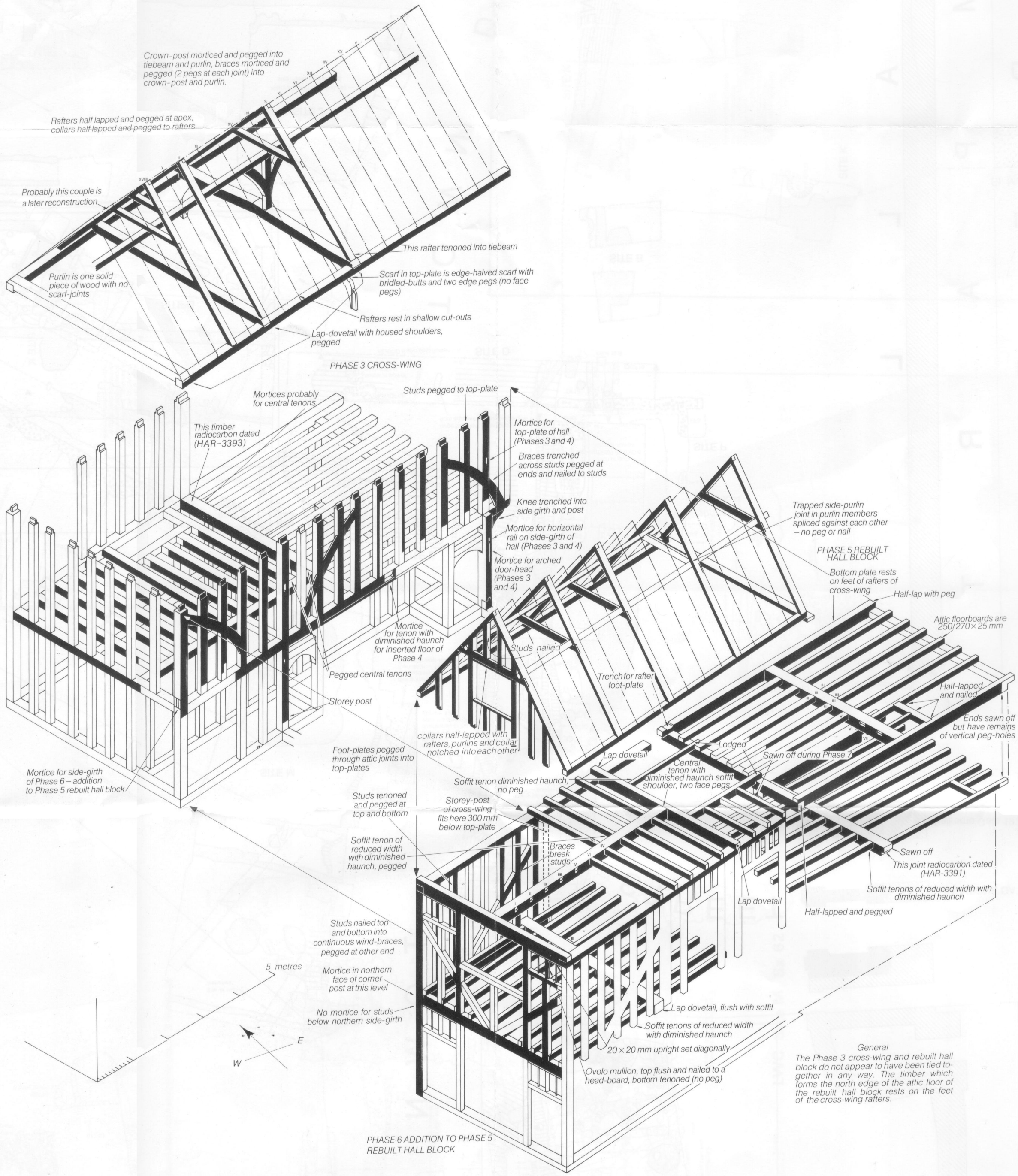
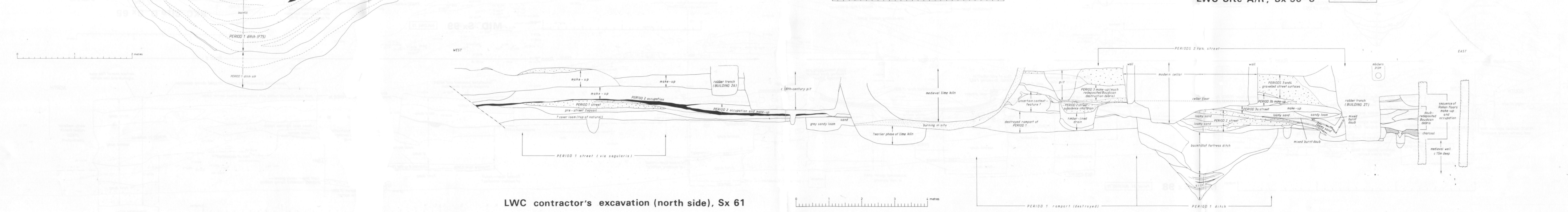
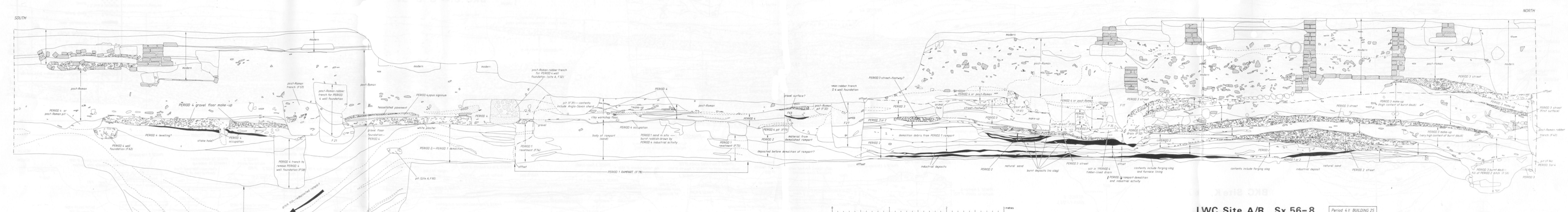
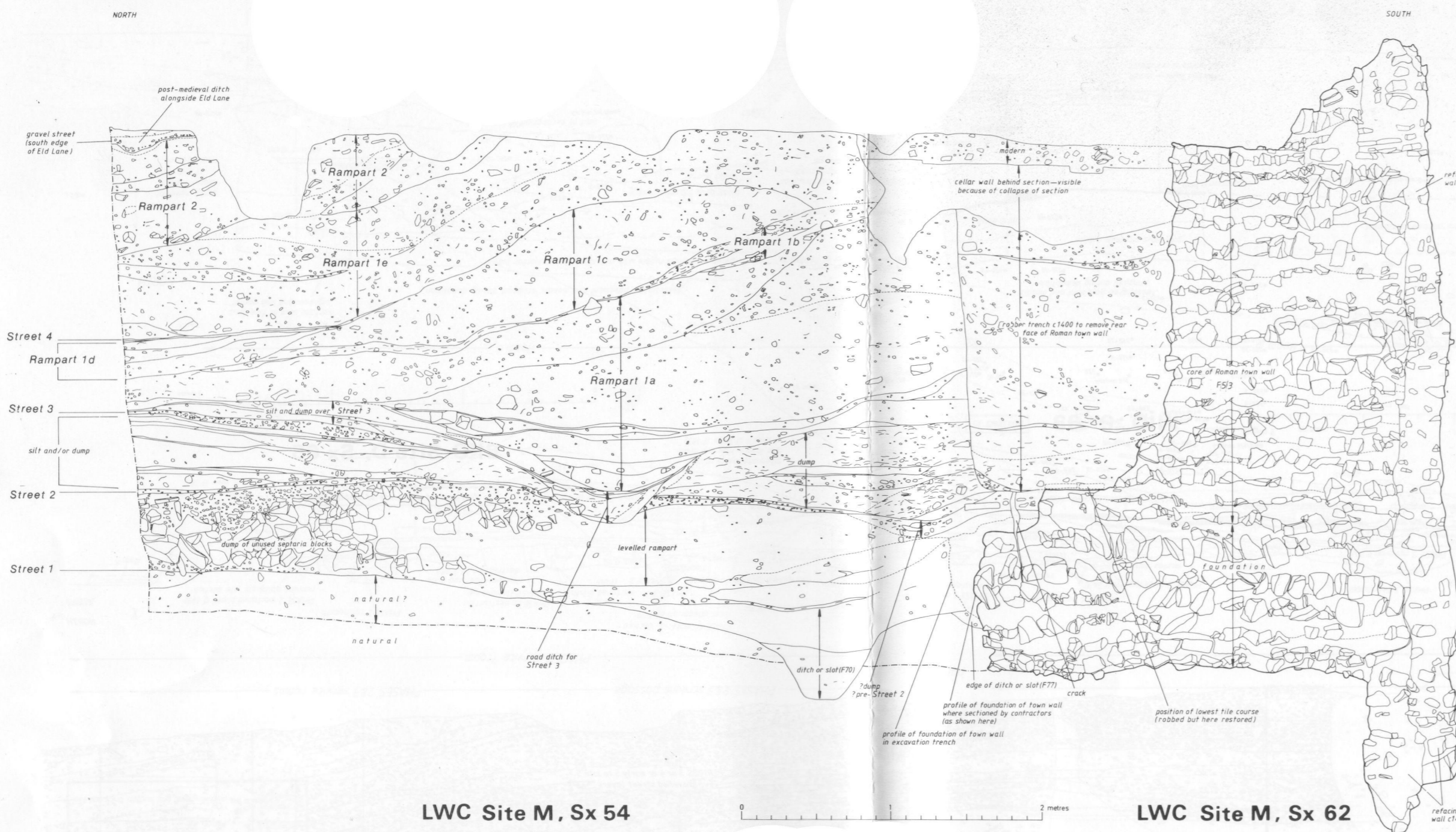


Fig 192 The surviving timber-frame of Building 76 (surveyed and drawn by N A Smith and R H Moyes). [Pages 207-8]





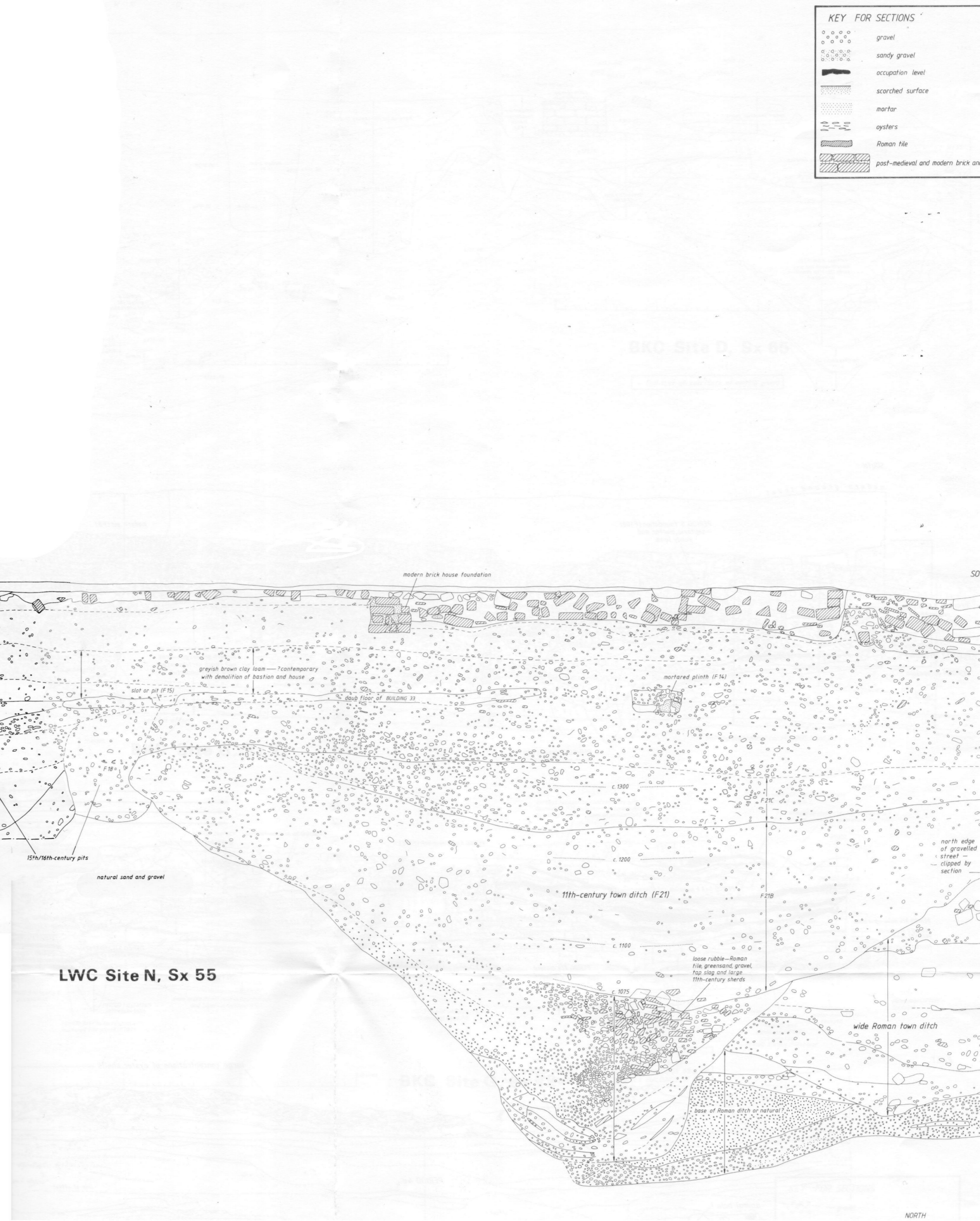




LWC Site M, Sx 54



LWC Site M, Sx 62

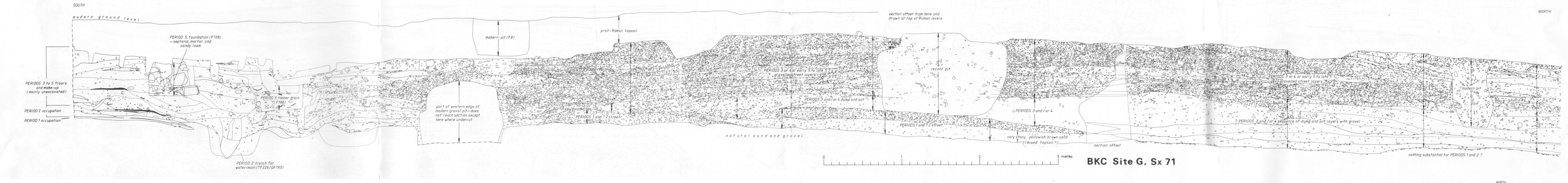
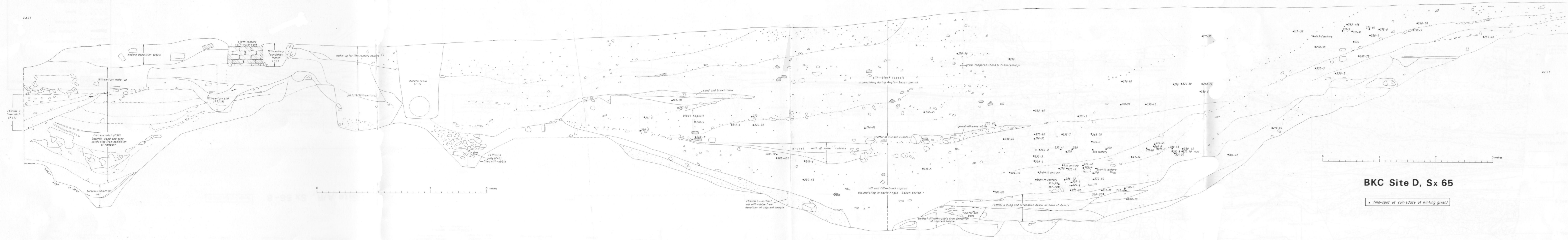


LWC Site N, Sx 55

KEY FOR SECTIONS

	gravel
	sandy gravel
	occupation level
	scorched surface
	mortar
	oysters
	Roman tile
	post-medieval and modern brick and tile















COLCHESTER ARCHAEOLOGICAL REPORT 3:

Excavations at Lion Walk, Balcerne Lane, and Middleborough,  
Colchester, Essex

by Philip Crummy

MICROFICHE SUPPLEMENT

REDUCTION: 25X

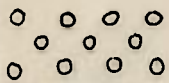


Colchester Archaeological Trust Ltd 1984

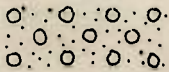
## CONTENTS

Figures relating to the printed text (Figs 3, 58, 71, 123, 130, & 134-5)	227
Appendix 1: Human remains from Lion Walk and Balcerne Lane by <u>R Luff</u>	232
Appendix 2: Examination of a lead coffin and its contents from Balcerne Lane by <u>P M Barford</u>	238
Appendix 3: The stone architectural fragments by <u>Nina Crummy</u>	260
Appendix 5: The Roman tiles by <u>Nina Crummy</u>	295
Appendix 6: Tables showing the Roman painted wall plaster from Buildings 8, 67, 69, 70, and 71	302
Appendix 8: Descriptions of complete or nearly complete buried pots by <u>Robin Symonds and C M Cunningham</u>	307
Appendix 9: A green-stained soil sample from a pit at Lion Walk, Site J by <u>S Limbrey</u>	319
Appendix 10: Summary of the ceramic dating evidence for some key areas at Lion Walk and Balcerne Lane by <u>Robin Symonds</u>	320
Appendix 11: Carbonised cereals and crop weeds from Buildings 38, 41, and 45 (Balcerne Lane) by <u>Feter Murphy</u>	341
Appendix 12: Soil monolith through the cultivated soil of Period 5 and early Period 6 at Balcerne Lane by <u>Feter Murphy</u>	358
Appendix 13: Summary of the products of the Roman kiln F1019 at the Middleborough site by <u>Robin Symonds with a contribution by K F Hartley</u>	360
Appendix 14: Miscellaneous soil samples from the Middleborough site by <u>Peter Murphy</u>	365
Appendix 15: List of significant charcoal samples <u>identified by A J Gouldwell and Maisie Taylor</u>	368
Sections 1-112 (except Sxs 43, 54-8, 61-2, 65, 71-2, 75, 98-9)	368

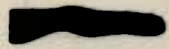
## KEY FOR SECTIONS



*gravel*



*sandy gravel*



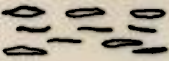
*occupation level*



*scorched surface*



*mortar*



*oysters*



*Roman tile*



*post-medieval and modern brick and tile*

Fig 3 Section conventions



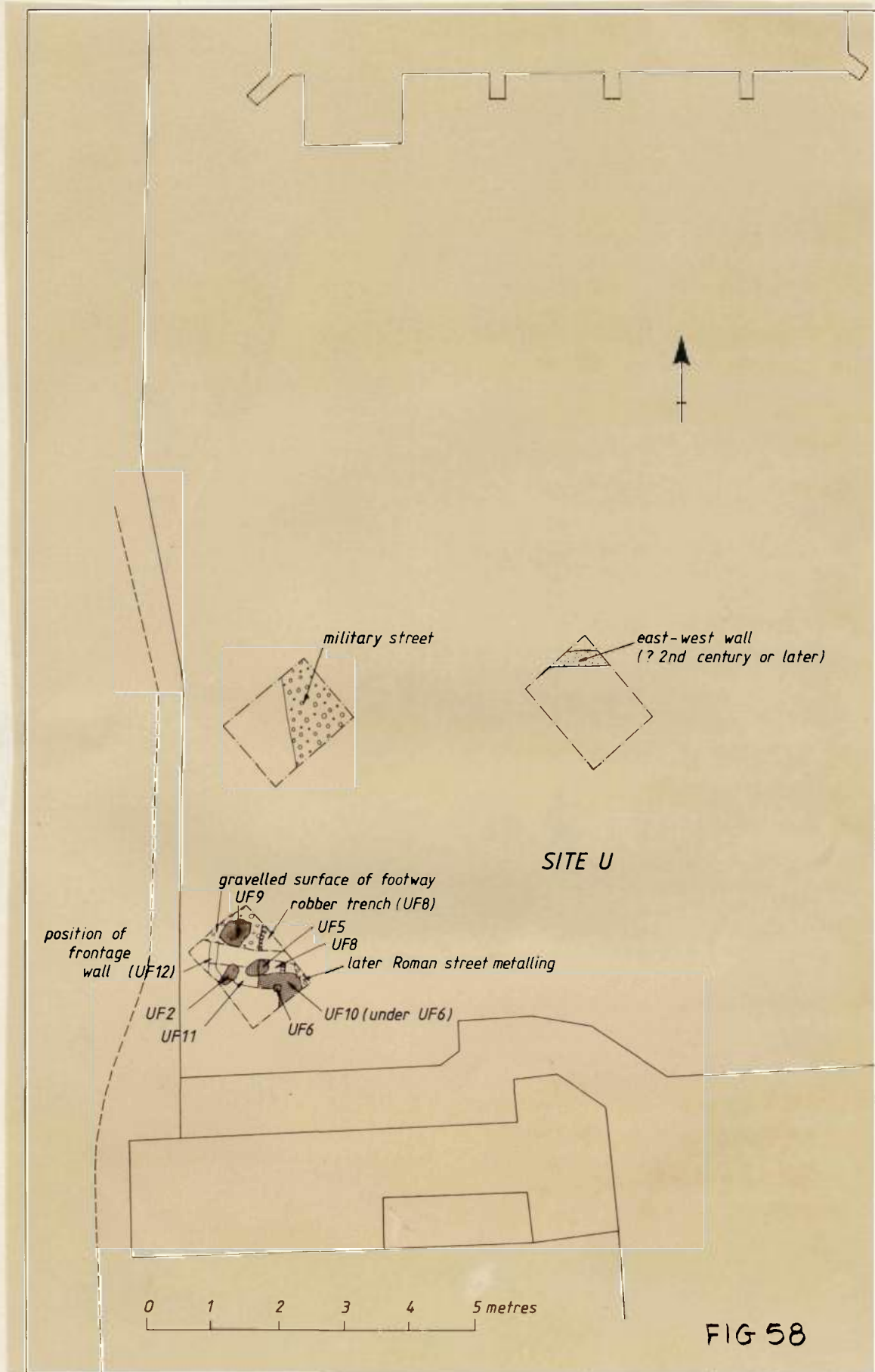


Fig 58 Location of Site U and detailed site plan

FIG 58

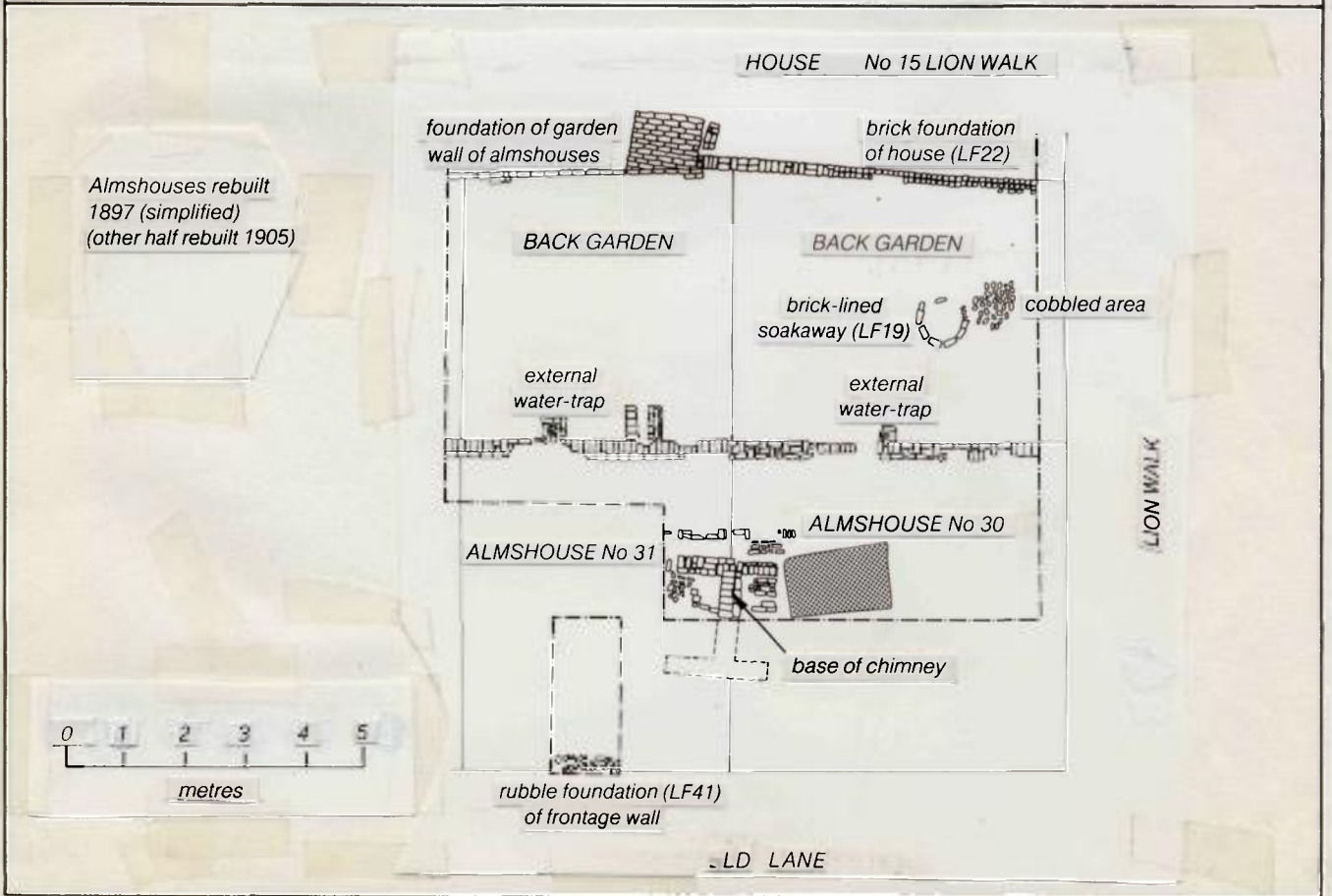
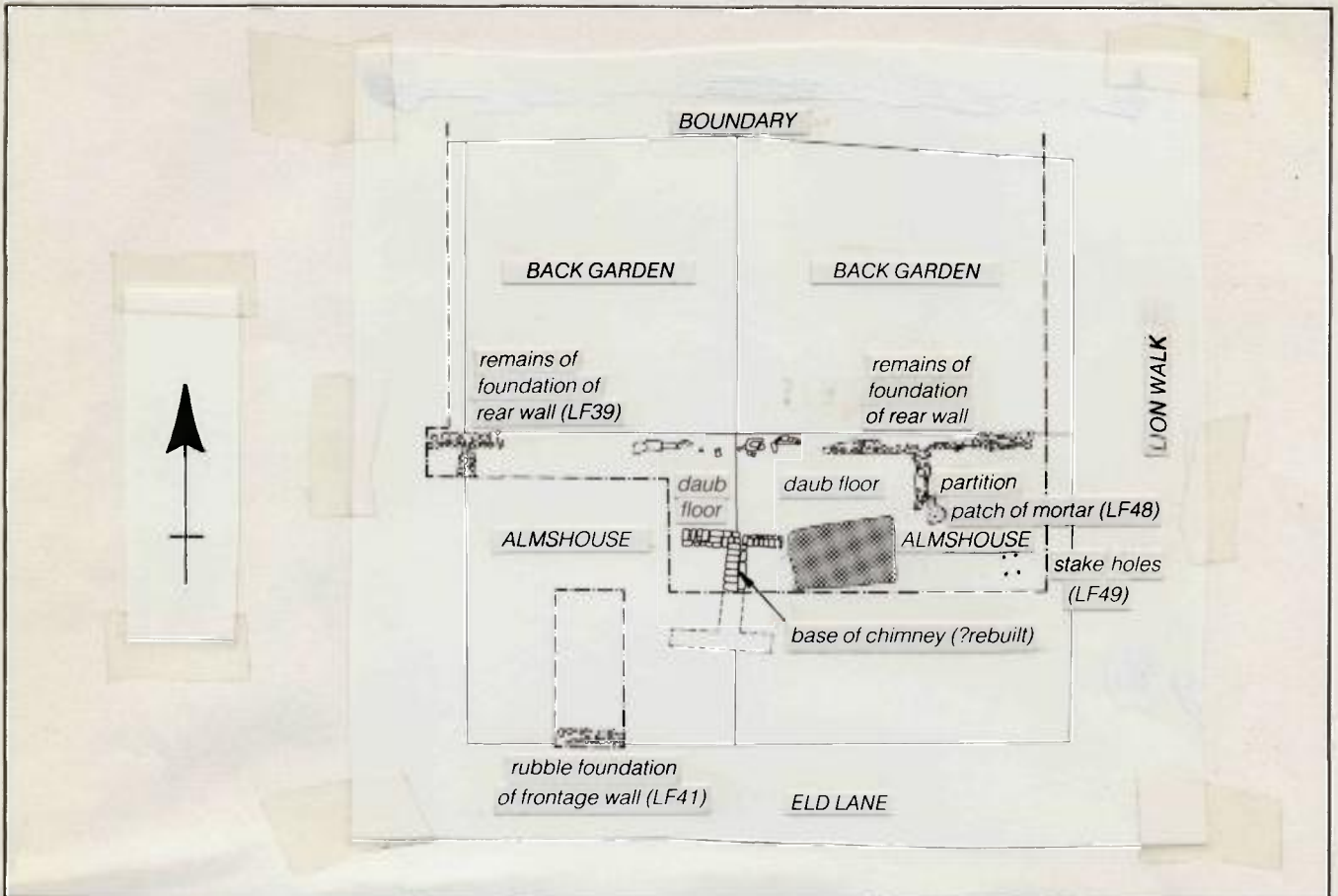


Figure 71 Buildings 31 (top) and 32 (bottom)



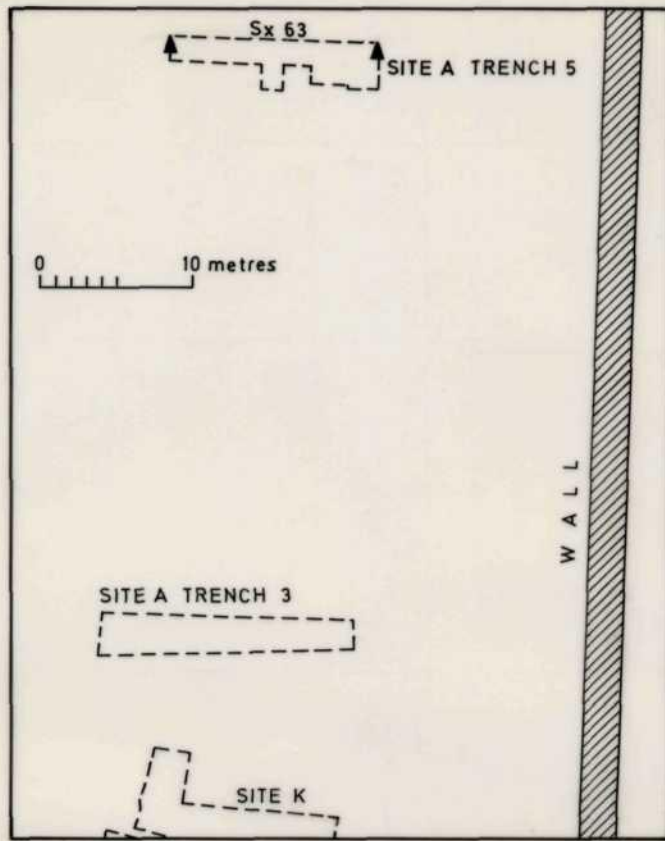


Fig 134 Location of Site A Trench 5

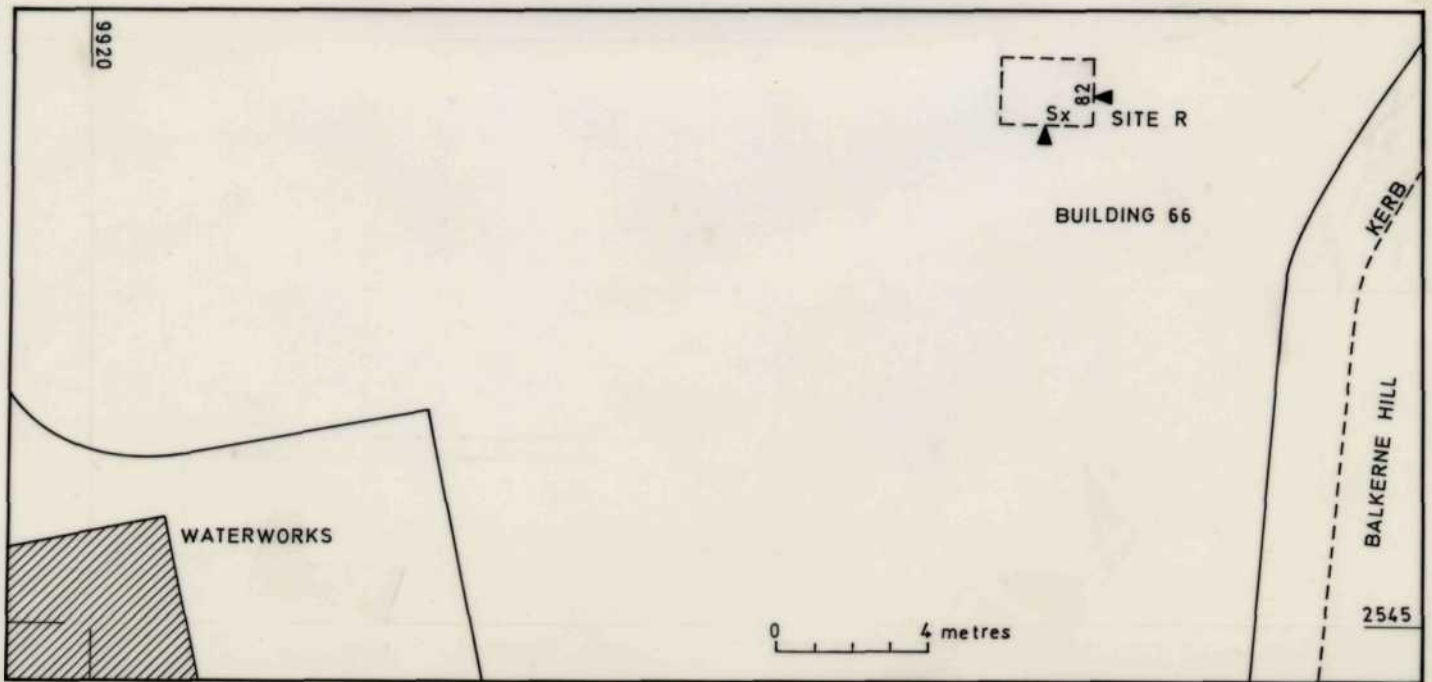


Fig 135 Location of Building 66

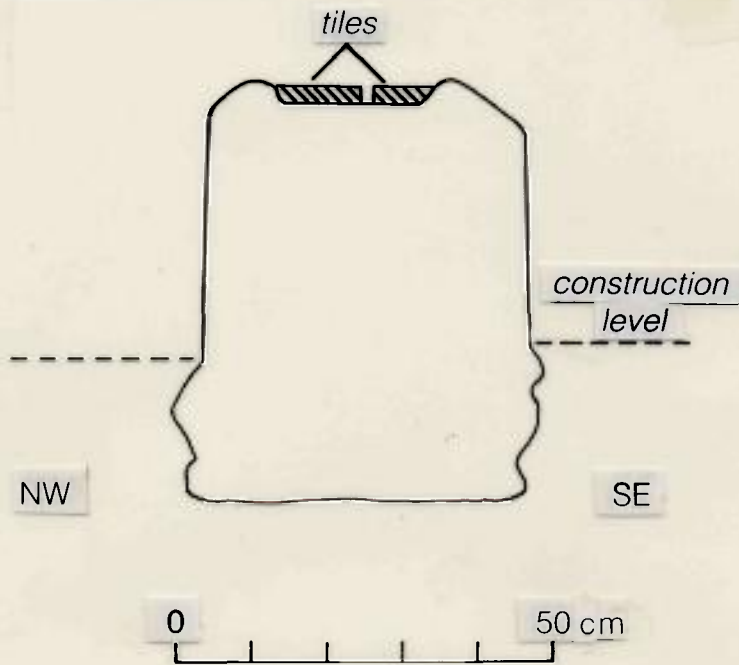


Fig 123 Profile of foundation of Building 59

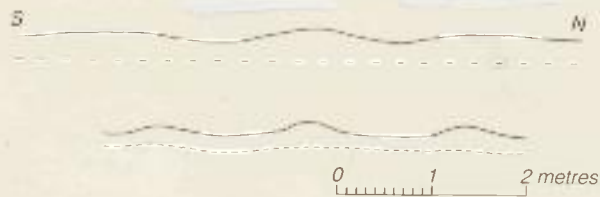


Fig 130 A profile of the allotments compared with a profile across modern asparagus beds in the Cher valley, France

## APPENDIX 1

## Provisional lists of human remains from the Lion Walk and Balcerne Lane sites

by R Luff

Additional human material is likely to come to light before completion of the study of all the bone from Lion Walk (LWC) and Balcerne Lane (BKC). The following two lists are thus provisional and reflect progress by October 1982. The human bone from the legionary ditch discussed in the printed element of this publication (pp 94-8) is included below. Full lists will be given with the bone reports which will be published in a later volume of the Colchester Archaeological Reports.

In the following lists, the find numbers are shown in brackets on the left and the dates of the contexts are shown in brackets on the right.

Neonatal remains

At the Balcerne Lane and the Lion Walk sites, a total of five, possibly six, neonatal inhumations were found in situ. All were of Roman date apart from one which was medieval. In addition, eight groups of bone were found which were in secondary contexts and had presumably derived from disturbed burials of neonatal babies. These remains of these are very incomplete. Dr Rosemary Powers of the British Museum, Physical Anthropology, has very kindly allowed the use of unpublished data in order to determine the infants' ages. However it must be stressed that since their plane of nutrition is unknown, any assessment must be viewed with caution. Most of the Roman burials appeared to be of babies prematurely born.

- + BKC HF28 (72, 75, 78) 5 bone frags, long bone epiphyses unfused (Per 6).
- + BKC JL4 (35) 7 bone frags representing 3 children, long bone epiphyses unfused (Per 5b).
- + BKC JL17 (99) 5 bone frags, long bone epiphyses unfused (Per 5c).
- + BKC JL27 (202) 11 frags representing 2 children, long bone epiphyses unfused (Per 3/4/5a).
- + BKC NL3 (35) 5 bone frags, long bone epiphyses unfused (Per 3).
- +? BKC N F34 (119) 2 long bone frags, long bone epiphyses unfused (Pers 1-5a)
- \* BKC TF58 (126, 127) 69 bone frags, long bone epiphyses unfused (Per 3) (Building 48?)
- \* BKC TL5 + TF25 (86) 7 bone frags, long bone epiphyses unfused (Per 3) (Building 48? - probably same as BKC TL5 above)
- \* BKC TF73 (167) 12 frags, long bone epiphyses unfused (Per 3) (Building 47?)
- +? BKC VL54 (497, 502) 4 frags representing 1 right leg + 34 frags representing 1 child, long bone epiphyses unfused (Per 2 &/or 4) (Building(s) 61?)
- \* LWC BF248 (678) 19 bone frags, teeth remains indicate at least two babies (Per 5) (under mortar floor of cellar of Building 22)
- \* LWC GF224 c 1150-c 1500 in floor of Room 3a in Building 28
- + LWC G (127) ?part of LWC GF224 (from layer above)
- +? LWC KF64 (141) 1 bone frag (post-Roman)
- \* LWC KF367 (627) 11 bone frags (Per 1 or 2)
- + LWC L (352) 3 bone frags (Per 4(1))

\* found in grave                      + residual in later contexts



Other remains

## Complete skeletons (inhumations)

- BKC AF47            adult (skull dug up and stolen overnight) (late Period 6 or early Anglo-Saxon) (see below for further details)
- BKC J                child in lead coffin from Period 6 pit JF32 (Fig 132, see Appendix 2 for further details)

## Partial remains in fill of legionary ditch at Balcerne Lane (c AD 50/5)

- BKC DF50 (417)            left femur shaft; right scapula
- " (434)                right femur shaft
- " (440)                right and left femur shafts with 2 frags of a female pelvis
- "                        left and right femur shafts; 3 pelvic frags; whole left femur shaft; right scapula; right femur shaft
- BKC EL324 (863)            4 mandible frags, 17 to 25 years old showing considerable alveolar resorption
- BKC EL324 (866)            left femur shaft
- BKC EF230+ (1016)        left maxilla and palatal; 2 frags of right and left mandibles, male aged 17 to 25 years old; right maxilla; right and left mandibles with right third molar impacted and incisors crowded, male aged 17 to 25 years old
- BKC EL284 (1027)        right tibia shaft; clavicle; right scapula
- BKC EL454 (1095)        right femur shaft; femur head; male pelvic frag



BKC EL10	femur shaft
BKC EL361 (1233)	pelvic frag, male
BKC EL324 (1316)	right tibia shaft
BKC P (26)	remains of a male skull aged 17 to 25 years old
Other partial remains	
BKC A (11)	femur shaft (Per 6 or later)
BKC AF16 (72)	ulna frags (Per 6 or later)
BKC AL4 (91)	3 femur shafts; 1 humerus shaft; 2 right maxillae; ulna; premolar; left femur proximal/distal; basi-occipital; tibia shaft (Per 6 or later)
BKC AL15 (110)	femur shaft; thoracic vert; mandible frag (Per 6 or later)
BKC AF50 (144)	left femur head (Per 6)
BKC AL7 (181)	3 cranial frags (post-Roman)
BKC A (185)	right proximal femur; 2 mandible frags; 2 skull frags
BKC CL44 (252)	left tibia shaft, proximally and distally gnawed by a dog (Per 2 or 1)
BKC C	2 frags of mandible from an old woman, pre-mortem loss of molars (Per 2 or 3)
BKC EL10 (16)	femur shaft
BKC EF24 (103)	right ulna, possibly male (post-Roman)
BKC E (188)	human foot including 5 metatarsals, 2 cuneiforms, 5 first phalanges, 5 second phalanges, 1 third phalanx; 7 ribs; 1 cervical vertebra
BKC EL43 (F38) (233)	right humerus shaft (Per 6 or post-Roman)
BKC EF92A (242)	tibia shaft (Per 6)

BKC EF24 (294) right distal humerus (post-Roman)  
 BKC EF108 (336) rib frag; 2 fibulae frags (post-Roman)  
 BKC EL128 (1051) cranial frag, parietal (Per 2)  
 BKC EL128 (1051) right femur shaft and head, male; right humerus shaft;  
 2 pelvic frags; cranial frag (Per 2)  
 BKC E (1244) left femur shaft and head; parietal frag (mod)  
 BKC DL2 (124a) male cranial frag, frontal/orbit (Per 6)  
 BKC G (320) cranial frag, occipital (Per 1 or 2)  
 BKC KF52 (119) femur shaft; pelvic frag; left proximal tibia; ulna  
 fragment  
 BKC K 56 (561) fibula which is abnormally bowed (Needs to be X-rayed  
 but does not appear to be a fracture. Could be  
 evidence of some nutritional disease, eg rickets.)  
 BKC KL125 (551) left femur shaft (Per 2)  
 BKC KF6 grossly deformed femur, fracture (Per 6)  
 BKC J (69) 2 cranial frags frontal (modern)  
 BKC JF36 (166) 2 cranial frags frontal/orbit (Per 5b)  
 BKC J (175) occipital bone (modern)  
 BKC JF184 (407) mandible belonging to elderly person, sockets of  
 molars 1, 2, and 3 healed over (Per 3/4/5a)  
 BKC NL3 (118) cranial fragment, frontal/orbits possibly female; right  
 tibia shaft (Per 6)  
 BKC NF34 (119) ulna (Per 5b)  
 BKC TL2 (26) thoracic vertebra (end of Per 3)  
 BKC TL19 (140) left ulna (Per 2 destruction)  
 BKC T (448) right tibia shaft (unstrat)  
 BKC T (475) cranial frag, parietal/occipital (Per 2b?)  
 BKC T (479) right humerus shaft (Per 2?)  
 BKC T (510) axis (Per 1 or 2)

BKC TF206 (567)	left whole tibia shaft (Per 1)
BKC TF230 (618)	male skull remains and left ulna which has male characteristics (Per 1)
BKC VL72 (386)	right femur shaft (Per 4)
BKC VL72 (595)	left humerus (shaft/distal); right humerus (shaft/distal) (Per 4)
BKC V (608)	left whole femur shaft (Per 5 or later)
BKC VL93 (767)	right femur shaft (Per 2)
BKC VL93 (772)	left tibia shaft; right humerus shaft, the latter is butchered (Per 2)
BKC V (1155)	cranial frags, parietal frags (Per 4)
LWC BF150 (403)	mandible, male aged 17 to 25 years (Per 2 destruction)
LWC BF70 (429)	left femur shaft, prox and dist gnawed by dog (Per 5)
LWC C (128)	6 skull fragments indicate a probable female of 15 years (post-Roman)
LWC K (421)	femur shaft (med or later)
LWC K (450)	cranial frag, parietal (med or later)
LWC M (172)	left femur shaft (1st century)

The skeleton BKC AF47

The skeletal remains from AF47 (Fig 133) consist of the post-cranial bones minus parts of the feet, hands and vertebral column. The individual was identified as a mature female. The sacrum had fused to the right and left innominate bones and there was an anomaly in the articulation between the scapula and humerus, possibly due to a dislocation. The height of the woman was calculated as 4 ft 11 in after Trotter and Gleser 1952 and 1958.



**APPENDIX 2****Examination of a lead coffin and its contents from Balkerne Lane, Colchester**

by P M Barford

[Summary: pp 144-5]

The coffin

The coffin was found in 1975 badly distorted, in what was obviously not its original position in a late Roman sand-pit (Fig 106). The coffin was rapidly cleared and lifted unopened, to prevent its possible overnight illicit removal for scrap metal. The burial was examined in Colchester, the upper fill of the coffin only being excavated, but was later packed in polyurethane foam and transported to the Institute of Archaeology, London where the writer began work on it. On receipt it was seen that only the upper fill of the coffin had been removed, and that the burial consisted of a mixed mass of fragmented plaster and disarticulated bones with an admixture of soil and sand. The surface of this layer sloped down towards the foot end.<sup>1</sup>

The lead coffin itself is 1.05 m long externally and tapers from 0.24 x 0.22 m high at the head end to 0.21 x 0.17 m high at the foot end (Fig 132). The body of the coffin is folded from one sheet of metal, the lid being separate. The sheets vary in thickness and seem to have been cast in open sand or clay moulds (Fig 195). Cooling and oxidation wrinkles on the upper surface show that pouring had been done from several positions at one time, probably indicating the use of more than one crucible (Fig 195). Decoration had been impressed in the surface of the mould, with real scallop shells, rings and solid circular motifs, and bead-and-triple reel decoration probably

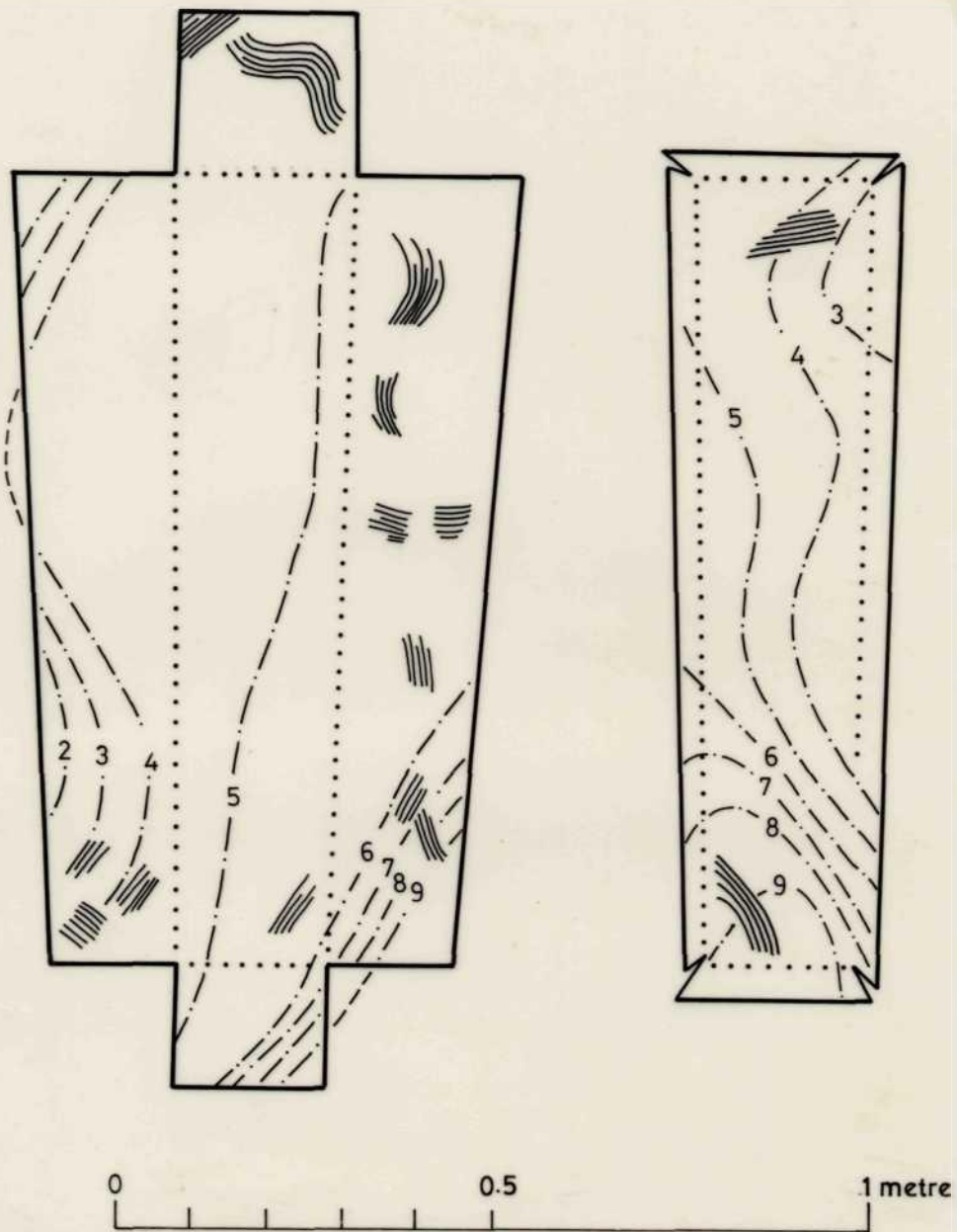


Fig 195 Thickness of the lead forming the coffin, and cooling wrinkles



made with a wooden batten 15 mm wide and about 0.7 m long. When the metal was poured, a porous effect was formed in the metal over deep parts of the decoration.

The sheet was cut up with a wide-bladed chisel which left visible tool marks, especially noticeable on the lid. The blade of the chisel was slightly curved and approximately 65 mm wide. After cutting, the edges of the sheet were hammered to thicken the edges in places. The sheet was then folded and the edges hammered together and hard-soldered. Two types of hammer marks are visible on the coffin; a round hammer (diameter about 15 mm) with a slightly convex face, and a heavy, square-faced hammer (possibly about 40 mm across) with rounded corners.

Although there were no traces of nail-holes for fastening, there was a wooden outer coffin or sarcophagus, as shown by two small areas of mineralised wood. One is on the outer surface of the foot end of the lid on the left side, the other is on the outside of the base midway from the right side. Although the wood has not been identified, it seems genuinely 'replaced' (Keepax 1975) rather than preserved by toxic metal salts. In both cases the grain of the wood runs along the axis of the coffin.

During the post-burial disturbance, the coffin was badly distorted and the corner seams burst. The damage seems consistent with excessive pressure from above. It seems that this damage occurred after exhumation (see below).

#### The body

The body was that of a child aged about five years (on the evidence of

the teeth, following Brothwell 1972, fig 24). It had been buried wrapped in several layers of textile covered in plaster. There was no sign of cause of death or any other pathological condition on the bones.

The bones were in great disorder (Fig 132). Also several bones had partially dissolved (most of the long bones, ribs and vertebrae) while the bones of the hands, feet, pelvis, and sacrum had almost totally dissolved; this was in part due to the effects of the burial environment in the coffin.

In order to follow in detail the processes taking place within the coffin (specifically the movement and disintegration of the body), a 1:1 cardboard mock-up was made of the coffin and marked with the areas of corrosion products. A measured, accurately articulated model of wood and plastic sheet was made of the body. This was used to imitate the movement of the different components of the skeleton as the coffin was tilted in different ways, in order to understand better its final disposition. It was found that this approach was very helpful in solving a number of problems. It was always apparent that the coffin had been moved in antiquity and thus interpretation of its interior produced problems not normally encountered in more static archaeological features.

The body had slid down to the head end of the coffin and mostly on the left side. From the disposition of some of the bones (the legs, ribs, and vertebrae), it appeared that this had happened prior to the completion of decay, and that some of the bones were still partially joined with flesh. It is not possible to suggest just how long a period of time this represents<sup>2</sup>; it would probably vary a lot with the conditions of burial.

During excavation of the remains, many small snail shells were noted.

They were all of the same type, ie the burrowing species cecilioides acicula (Evans 1972, 168).<sup>3</sup> This species is probably a post-Roman introduction to this country and can burrow to considerable depths. The presence of these snails in the coffin may be purely fortuitous.

During disturbance, the upper part of the body doubled up on itself so that the skull ended up resting on its right temple in the chest cavity, the vertebral column breaking up in the process. An area in the head end of the coffin some 150 mm long was almost clear of skeletal material and plaster and may possibly represent a pillow which the body had slid up against. The body seems to have broken at the waist; the hips and legs tilted over to the left and doubled-up. The arms are in a position which is difficult to account for, the right arm was behind and underneath the head, the left was bent round the back of the head. Probably decay had loosened the shoulder joints and the arms were no longer attached to the body. The final position of the other bones were consistent with the break-up of a body in the condition outlined above.

#### Plaster and impressions

It was always apparent that the plaster was much fragmented, but only on completion of excavation could it be seen that there was in fact very little remaining. Only near the foot end was one fragment found, still probably near its original position, though much broken up. The rest of the plaster was scattered as fragments among the bones in Layer (4) of the fill.<sup>4</sup>

Reassembly of the plaster was made difficult by many missing fragments, the amount of plaster that had been comminuted was shown by the high content of crushed plaster in Layer (4) of the fill. It was for this reason that it



was impossible to re-assemble the entire body-cast as had originally been hoped. (Compare RCHM York, 108-9 & pl 33.) Only one largish area could be reassembled, and even on this, the impression is incomprehensible.

Elementary chemical analysis of several random samples showed that the plaster was a gypsum plaster.<sup>5</sup> There was evidence of several layers of plaster with marked interfaces, representing the application of several different mixes of liquid plaster. Some of these mixes differed markedly in texture, and, had more plaster been preserved, this would have helped sorting and re-assembly of the fragments. The first mix added was cream-coloured and full of small air bubbles. This had been poured directly on to textiles covering the body; where these were creased the plaster penetrated the textile. The rest of the plaster was whiter and mostly more compact, but some areas which were rather soft and porous, seemed to come from the right hand side of the coffin.

The plaster varies greatly in thickness from 30 mm to 10 mm, but averaging 15 mm thick. Many pieces, mostly thin, show smooth upper surfaces although the largest assembled fragment has a very uneven surface, which has been given a thin slurry of white plaster. This surface has a groove on it (Fig 199). On another fragment are two, possibly three, impressions on the surface opposite to the textile impression. Their meaning is unclear, though they are apparently not finished surfaces (Fig 196).

The textile impressions are very poor and the effect disappears under magnification making examination and cleaning very difficult. Two textile types were observed. In no case were edges or seams apparent.

Textile A. This seems to be a fine plain weave fabric. The thread count is

one way 16 threads and the other 10 threads (warps?) to the centimetre, but this varies a bit where the fabric seems to be under tension. This textile was laid with the 'warps' running along the axis of the coffin. Since it occurs on the majority of fragments with impressions, it seems likely that this textile represents a shroud laid over the body.<sup>6</sup>

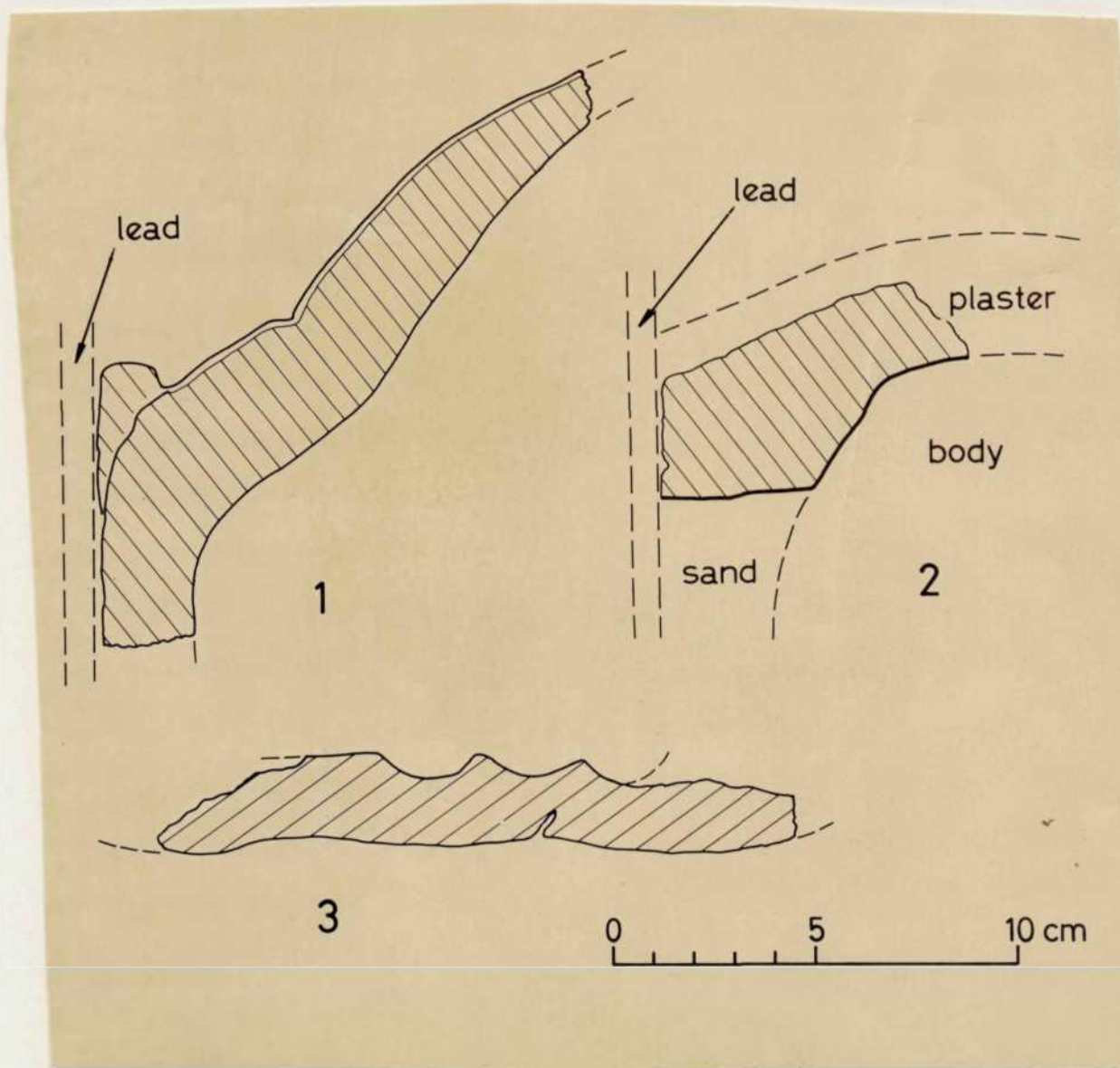


Fig 196 Sections through plaster fragments found in the lead coffin



In several places 'replaced' textile was found, especially round the feet. Here Textile A could be seen to be made in Z-twist yarn. Although the feet were lifted in a soil block little sense could be made of the replaced textiles due to their extreme fragility but there were obviously several different weaves present. Dissolution of a small sample in a strong solution of disodium EDTA<sup>7</sup> showed that this was a true case of 'replacement' and not simple encrustation, as no organic residue remained. The mechanism of formation of mineral replacements of organic material remains unknown.

Apart from the material around the feet, small fragments of 'replaced' textile were found loose in the fill of the coffin (mainly in Layer (4)). One largish fragment was found on the underside of the largest assembled fragment of the plaster, though not actually attached to it. This consisted of a small piece of Textile A lying on a larger fragment of Textile B.<sup>8</sup>

Textile B. This was present as small areas on the largest assembled plaster fragment, the plaster penetrating the folds of the cloth sometimes. The impression is poor and the textile heavily creased. Textile B is also plain weave and gives the impression of being a coarser cloth, but is in fact finer than A, having 20 threads per centimetre one way and 16 the other.<sup>9</sup> This fabric was not detected in the textile around the feet. Possibly Textile B was from the child's clothing.

Other textiles. As noted above, little sense was made of the fragments of replaced textile around the feet, but it did seem that other textiles not apparently registered in impressions on the plaster were present here.

Red stains. Some of the fragments of plaster with smooth upper surfaces had on these surfaces reddish-brown patches, resembling paint, but it was

originally thought that this could represent libations applied to the surface of the prepared burials. These patches were in the nature of an accidental stain rather than that of a pigment, and occurred on the bones also, including the inside of the cranium. The random nature of the staining suggests a natural origin, probably this is lead monoxide precipitated from soluble lead salts derived from the corrosion of the coffin.

#### The coffin fill

Observation of the several layers within the coffin was hampered greatly by the quantities of fragile plaster and bone in the coffin, a situation made worse by the mixing and compression of the contents. Thus it was difficult to examine large areas of soil matrix at any one time.<sup>10</sup> The stratigraphy seems to have been:

- 1) The coffin itself.
- 2) Compact clean yellow sand, few small pebbles resting on the bottom and thickening considerably to the head end and right side of the coffin. Contains no plaster or bones.
- 3) Compact clean orange sand, few small pebbles and a few iron concretions, containing few plaster fragments or bones. Overlies (2).
- 4) Medium brown with few small pebbles. Contains the majority of the bones and most of the plaster. Overlies (2) and (3).
- 5) Dirty yellow sand with no pebbles, occurs as small patches over and mixing with Layer (4). Contains little plaster and bone.
- 6) This layer was removed by the excavators and was probably soil that had leaked into the coffin through the burst seams. Layers (2) to (5) had slid down to the head end of the coffin (the surface at a gradient of 1:7 relative to the base), leaving a vacant space at the foot end of the coffin which had filled with soil.<sup>11</sup>

Interpretation of these soil layers is not, however, solely concerned with establishing superposition. This is no help in studying a dynamic situation, both in terms of disturbance of the soil layers, and changes in soil composition due to burial environment within the coffin (see discussion below).

#### Lead corrosion products on the coffin

The lead of the coffin exhibited several different types of corrosion products on its surfaces (Fig 197). It was apparent that a careful consideration of these could give valuable archaeological information, since they are a product of the burial environment. They will be numbered sequentially with the soil layers as they can arguably be regarded as archaeological deposits in their own right. It is unfortunate that no chemical analyses have yet taken place to confirm the visual identification of these corrosion products.

Lead is generally regarded as a fairly stable metal, since its common atmospheric corrosion products are insoluble and tend to form a protective coating on the metal surface. Some lead salts are, however, unstable and tend to be converted into basic lead carbonate<sup>12</sup> or lead monoxide. Some of these lead salts are also soluble and do not form protection films, and it is to these that we must look for an explanation of some of the observed phenomena. Lead is particularly badly attacked by organic acids, also ammonia and nitrates. These can be produced from the decay of animal tissue under certain conditions. For general details of the corrosion of lead, see Stambelov 1968 and Watson 1976.



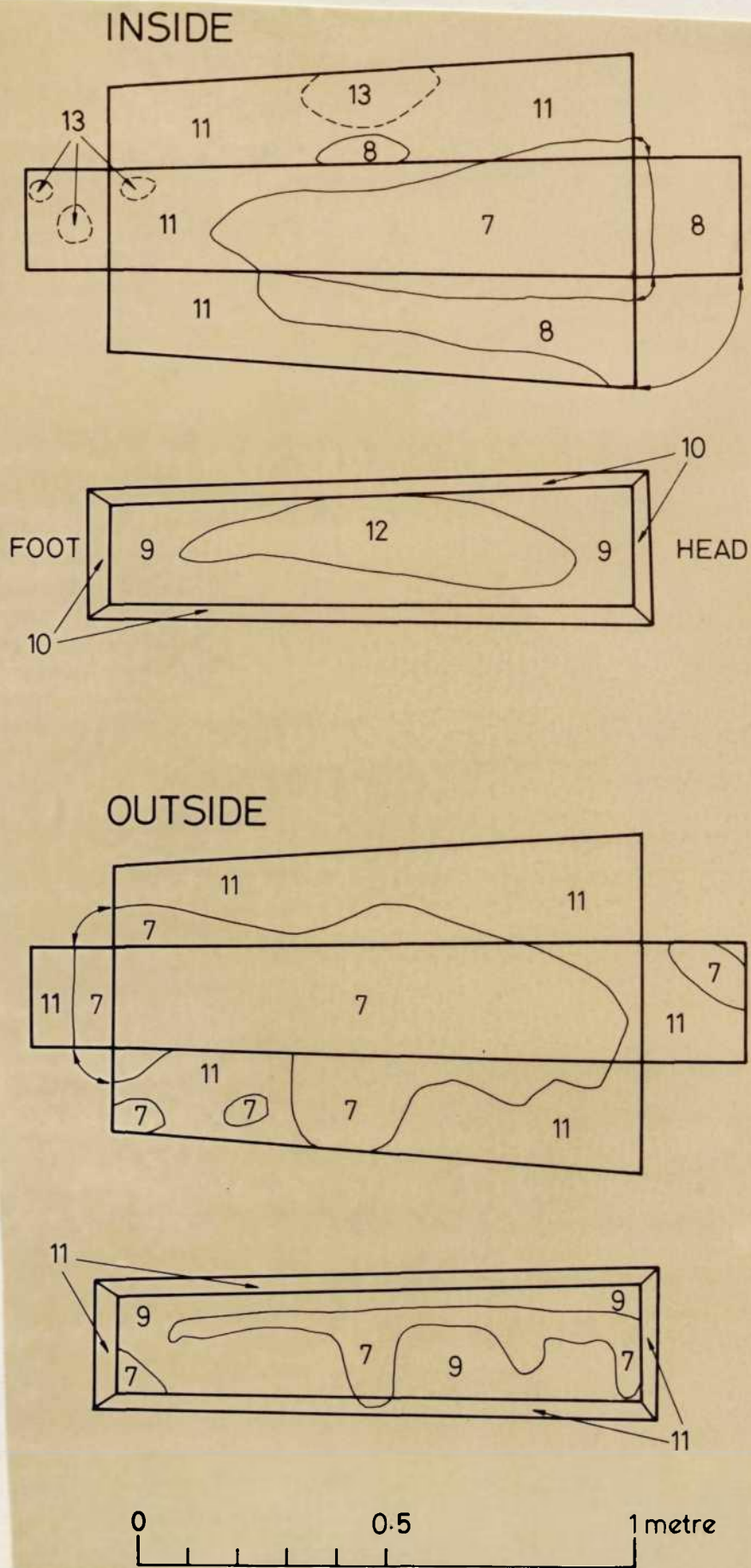


Fig 197 Pattern of corrosion products on the outside and the inside surfaces of the lead coffin

The observed corrosion products on the coffin were as follows:

- 7) Hard grey-white layered corrosion products. Often the metal beneath has been very badly dissolved. This corrosion product would seem to be basic lead carbonate, which can form from the breakdown of lead salts of organic acids (J Applied Chem, 8, 5 (1958), 341-8). The large area inside the coffin on the base at the head end (Fig 197) would seem to represent a pool of corrosive liquids from the (probably anaerobic) decay of the body. It seems from the shape of the layer that this had occurred while the coffin was tilted. Some areas of (7) on the outside of the coffin probably are due to the release of organic acids by the wood of the outer coffin.
- 8) Hard white-grey gritty layer over a red lead monoxide layer. The distribution of this corrosion product also seems to match the disposition of skeletal remains in the coffin, as does (7). In certain cases this red monoxide can form from the breakdown of unstable lead salts and has possibly formed as above.
- 9) Very thin, smooth purplish-red monoxide layer containing small random black patches which may be lead dioxide or sulphide. Occurs on the outside and inside of the lid only. Texture slightly gritty outside the coffin.
- 10) Hard white gritty layer over red monoxide, similar to (8). Occurs in areas of the lid where it is in close contact with the upper edge of the coffin. This suggests that it formed under reducing conditions.
- 11) Thin grey compact and smooth layer, thicker and layered in places. Occurs over most of the outside of the coffin and inside on the right side and foot end. The red monoxide layer seems to be absent.
- 12) Very hard grey-green 'glassy' textured layer cementing sand and plaster. Overlies a red monoxide layer. Found inside the lid in the centre where



it had been depressed to come into contact with the plaster. A small sample removed and tested for sulphates<sup>13</sup> proved positive, but due to the presence of the gypsum plaster, this is not surprising.

13) Very similar to (12), but the colour is grey-blue. Occurs as small patches inside the coffin on Layer (11).

Corrosion products (8), (9), and (10) seem to be related, probably formed in reducing, perhaps only slightly acid conditions. Corrosion product (11) is similar, but perhaps conditions were not so reducing. Product (7), on the other hand, was probably produced under an extremely corrosive environment formed by an organic 'soup' at the bottom of the coffin. Possibly corrosion products (12) and (13) are patches of lead sulphate, an insoluble, usually white, substance formed when sulphate ions react with lead salts such as lead nitrate.

#### Discussion: mode of burial

In this section it is proposed to draw together the evidence presented above, itself necessarily somewhat interpretative in places, in an attempt to determine the original mode of burial and, in the subsequent section, examine the events leading up to its deposition in the feature in which it was found.

The sand (Layers (2) and (3)) under the remains of the body was originally thought to have washed into the coffin during disturbance. However, in order for this to have happened, the coffin would have had to have been upside-down to leave space for it here. Tests with the model indicated that this need not have happened to explain the disposition of the human remains. Furthermore, work on the plaster indicated that, all things considered, there was not enough to encase the body totally. It seems likely

that the body had been partially packed in sand before being covered in gypsum plaster. The section of one plaster fragment seems to support this suggestion (Fig 196.2). The volume of sand involved was calculated by making a heap in the base of the cardboard model coffin in the same configuration as Layers (2) and (3) and then measuring its volume, which comes out as just under 0.3 cubic metres. Near the foot end of the coffin was a small thin patch of soft white plaster without body or textile impressions, which had the appearance of being in situ. This need not, however, invalidate the idea of sand packing, as it might have been an accidental spillage, or may have been a secondary precipitate from a solution at the interface between two different environments formed during decay of the body.

During construction of the models, it was noted that the body would have been far smaller than the coffin, even allowing for the possible pillow. The height of the child would have been about 0.82 m (2 ft 8 in). It is unlikely that the coffin was custom-built and that this space was intentional. Possibly the vacant space was packed with sand, or maybe folded garments or other textiles would have been placed at the feet.

In the disturbance of the burial, the coffin was tilted and the body slid down towards the head end and towards the left. The sand slid down with it, presumably wet with body fluids and would thus have been heavy enough to flow freely. The sand spilled around the remains of the body, forming a thick lens on the right of the coffin, some of it spilling on top of the remains (Layer (5)).

The body had probably been shrouded in Textile A before the plaster (and sand?) were applied; Textile B could either have been another (or the same ?) shroud or the child's clothing. There was no evidence of bandaging of the

corpse.

The sand and shroud were then covered with several layers of liquid plaster. Green (1977) has suggested that the purpose of the plaster in plaster burials was to absorb liquids. The sand may have substituted for the, presumably expensive, gypsum plaster for the same purpose, though the corrosion products of the coffin seem to suggest that a corrosive wet slurry formed on the base of the coffin anyway. Toller (1977, 14-6) has discussed the 'mineral content' of coffins and suggests that rare gravel and sand fills have infiltrated the coffin naturally<sup>14</sup>, but in the case of the Balkerne Lane coffin, it seems likely that the sand was a deliberate packing. The purpose of the plaster capping is uncertain; perhaps it was an undertaker's deceit, or perhaps the plaster was to seal the coffin to keep out air or, more likely, water.

It seems most probable that the purpose of plaster burial was to preserve the body for a physical resurrection (Green 1977). It is not known whether the Colchester burial was embalmed or not. Certainly if it had been embalmed, this could have some bearing on the amount of time between burial and disturbance of the burial. Similarly toxic lead salts from the coffin might have had some effect in retarding decay, as might natural dessication, though this latter alternative seems to be argued against by the sliding of the body upon disturbance.

Toller (1977, 14-16) found that, apart from burials at York and Poundbury in Dorset, true gypsum plaster in plaster burials is rare. Most of the analysed plaster burials in the Essex area have contained lime plaster. The Chalkwell and Lullingstone burials in Kent also contained gypsum plaster (*id.*, 14). This distribution is partly explained by the distribution of



sources of gypsum. Toller suggests that this pattern could be studied with references to wall plaster. However it seems that much Romano-British wall plaster is lime plaster and Pliny (Nat Hist) specifically advises against the use of gypsum plaster in architectural work.<sup>15</sup> The gypsum of the Colchester burial could have come from the wealden Purbeck deposits (Gallois 1965, 18) but a more local source cannot be excluded. Selenite<sup>16</sup> crystals sometimes occur in the London Clay (Sherlock 1960, 33). In the Colchester region there are extensive deposits of London Clay in the low cliffs of the east coast of Tendring Hundred. These cliffs were probably exploited in the Roman period for building material (Morant 1748, 5). At Wrabness, quantities of selenite crystals can still be recovered from certain parts of the cliffs. Selenite was formerly found in the Harwich cliff (Dale 1732, 275) and former sources at Walton and Frinton are possible. Collection of selenite is not a particularly good source of gypsum for plaster, and possibly this is the reason for its economical use in the Colchester coffin.

Due to the disturbed remains, it is not possible to be definite about the original position of the body, but from tests with the model there is nothing inconsistent with it having been in an extended, supine position, possibly with the arms crossed over the body.

Within Layers (2) and (3) were found: a large brown flint pebble 60 mm long at the head end on the right hand side, three medium-sized pebbles, and a large (approx 50 mm across) ironstone nodule about 400 mm from the foot end of the coffin roughly in the centre. From Layer (4) came four oyster shells, present as single eroded and abraded valves and thus unlikely to be food offerings. It is hard to escape the conclusion that all of this material had originally been included in the burial, whether deliberately or not. The large pebble at least is too large to pass through the holes at the corner of

the coffin caused by the bursting of the seams and is thus unlikely to have come from the outside.<sup>17</sup>

The decomposition products of the body, with the addition of the products of decomposition of the decomposer macro- and micro-flora/fauna, produced Layer (4) presumably from the sand packing of the body (Layers (2) & (3)). Several black 'earthy' patches were found in Layer (4) which were at first thought to have been degraded animal tissue, but are more likely to have been the remains of roots. Many black soft decayed roots were found in the coffin. They could have been ancient, but are much more likely to have been comparatively modern.<sup>18</sup> Despite close scrutiny, no trace was found of hair, skin, adipocere or any other human tissue.

#### Dating

Generally, lead coffins tend to be late Roman and the custom of plaster burial seems to be a late introduction to Roman Britain. The Colchester burial contained no grave goods, and few of the other decorated lead coffins in the Thames mouth area have grave goods either, making close dating difficult. There are some similarities between the decoration of this coffin and that from Holborough, Kent, dated by Toynbee (1954, 34) to the early 3rd century. However, this was not a plaster burial. Some of the other Colchester lead coffins in Colchester and Essex Museum have similar decoration to that of the Balkerne Lane burial, but none of these have reliable dates either.



### Exhumation

From the evidence presented above, it seems that in the late Roman period a young child was buried in a plaster burial in a lead coffin contained in at least one wooden outer coffin. Presumably this burial was made in one of the town's cemeteries. It seems probable that the burial would have been roughly horizontal in its grave or tomb, and that it was only tilted after substantial decomposition of the body had taken place, thus allowing the body to break up and slide down to the head end of the coffin.

There is a strong possibility that the initial burial had been in an airy vault or mausoleum rather than a grave in the soil. This would, in certain circumstances cause only partial decay<sup>19</sup>, which did not produce the corrosive substances that later attacked the lead of the coffin. These, especially the organic acids, are more likely to have formed in the anaerobic decay of animal tissue. Furthermore, the demolition or reuse of a mausoleum could provide some explanation of the coffin's subsequent history. The coffin was violently lifted from its grave. The wooden outer coffin at this time was probably still fairly intact, as the lead coffin otherwise would probably have buckled. This would have probably burst the seams preventing the subsequent build-up of a reducing environment in the coffin and would also have allowed leakage of the corrosive liquids, rather than allowing them to build up in the coffin. In this lifting and subsequent transport of the coffin, the plaster of the burial fragmented and was comminuted, and the body, reduced to bones held together by partially decayed flesh and cloth, slid down to the head end of the coffin in a jumble.

As pointed out above, it is not possible to be certain of the length of time elapsing between burial and exhumation. It seems probable that some

form of embalming had been attempted in addition to the plaster and sand packing. It is unknown whether the coffin had been opened at the time of exhumation and anything removed. If it was, it may be noted that the lid of the coffin had been replaced carefully before the coffin was dumped.

The coffin was deposited in a large irregular pit, probably originally dug for sand or gravel extraction. The head end of the coffin, which contained most of the weight of the remains of the body, rested lower than the empty foot end of the coffin. The coffin was also tilted over slightly to the left. At this stage, anaerobic conditions probably developed and the lead of the coffin was attacked by corrosive substances derived from the decay of the remainder of the tissues of the body. The development of anaerobic conditions might imply that the coffin had been buried by the partial infilling of the pit. It is unknown whether this immediately followed the dumping of the coffin.

The burial probably remained in this condition for some time before the coffin was partially crushed. The pressure seems to have come from above, causing the coffin to collapse sideways to the left, and the ends to be crushed down on to themselves. The lid was depressed in the centre and the base buckled upwards, presumably the wooden outer coffin having now rotted. The main result of this was compression of the burial, and the bursting of the corner seams of the lead coffin. This would have allowed more free drainage for the first time and might have lessened the reducing conditions in the coffin. Thus, had any human tissue been initially preserved, it would now be broken down. This would bring the coffin up to the condition in which it was found in 1975.



### Conclusions

The discussion above has not added a great deal to what is already known about late Romano-British burial practice. The disturbed nature of the burial has, furthermore, reduced the reliability of the conclusions reached. However it is clear that a consideration of the changing burial environments within the coffin and their effects on the materials in the burial was able to resolve details of interpretation of the burial. The results of a study along these lines of the Poundbury burials (L Biek pers comm) should produce useful comparative data for the Colchester burial.

### Appendix: conservation

It was originally intended that the coffin would be cleaned after excavation. The corrosion products of the coffin were kept under observation and did not seem to be unstable. Cleaning was restricted to washing with tap water and gentle dry-brushing to remove most of the adherent soil to examine the corrosion products. This is because removal of the layers of corrosion products would have damaged the object since these layers contain information of possible archaeological significance and also much of the decoration especially on the lid.

It was unfortunately found necessary to consolidate both the plaster and bones from the burial after excavation. Both were very badly softened by conditions within the coffin. They were vacuum impregnated with the pressure (30 psi) decreased slowly, in 10% 'Paraloid' B72 (co-polymer of polymethyl methacrylate and methacrylate) and dried on coarse plastic mesh in an atmosphere of toluene vapour.<sup>20</sup> Some fragments were stuck with HMG (cellulose nitrate adhesive).

## Notes

1. In the descriptions throughout this report, 'left', 'right', 'head', and 'foot' refer to that of the body in its presumed original position as a supine extended inhumation.
2. Since the study of the decay of complete animal bodies has never been a particularly popular pastime!
3. This identification was kindly made by Dr K Thomas.
4. There was no plaster sealing the lid or on the outside of the coffin.
5. Lime plaster is calcium carbonate ( $\text{CaCO}_3$ ), while gypsum plaster is calcium sulphate ( $\text{CaSO}_4$ ). Simple test for presence of sulphate ion: 10% hydrochloric acid and a few drops of barium chloride solution, a white precipitate of barium sulphate indicates the presence of sulphates.
6. Dr J P Wild has commented that the term 'shroud' applied to Textile A may be misleading. He informed me that Roman burials did not as a rule have purpose-made shrouds but that the body was wrapped 'in all kinds of linen, complete items or rags, new and reused. The commonest item was like a modern tea-towel. It was often called a sabanum, a word borrowed into some Slav languages with the meaning shroud.'
7. Ethylene-diaminotetracetic acid.
8. This remains in position, consolidated in the soil on the plaster.
9. The impression was so poor that it was difficult to differentiate warp from weft.
10. Micro-excavation, as much as large-scale excavation, produces problems in spoil removal.
11. Space for this would be provided, even if the coffin had been completely filled originally, by the settling of fragmented plaster into the space left by the decay of the body.



12.  $2\text{Pb}(\text{CO}_3) \cdot \text{Pb}(\text{OH})_2$ . The proportions of the hydroxide to the carbonate varies.
13. See note 4 above for sulphate test.
14. His numbers 67, 88 (wrongly placed on his map 3), and 118.
15. It is not likely, however, that gypsum burials were the sole reason for the exploitation of this resource, but if architectural work is to be excluded, what was the gypsum being used for?
18. Crystalline gypsum.
19. The oyster shells may have had a similar symbolic meaning as the scallops may have had some more prosaic use in the preservation or preparation of the body.
20. These demonstrated that even after some 1500 years, there was probably still remaining some nutrients from the decay of the body.
21. As in the case of the bodies of certain Royal or ecclesiastical personages noted in the opening of their tombs in subsequent years, setting the seal on many a potential canonisation, but mostly due to the burial environment.
21. I would like to acknowledge the help and advice of members of the staff at the Institute of Archaeology, particularly Dr N J Seeley and Mrs K W Tubb, also Dr K Thomas; Mr L Biek gave details of his work on the Poundbury burials, Dr J P Wilde has commented on the reporting of the textiles, and Miss J Watson gave advice on the cleaning of the lead. All errors and opinions expressed are the responsibility of the writer. I would also like to thank Carole Schlarb for sorting out and typing a very confused manuscript.



### APPENDIX 3

#### Stone architectural fragments

by Nina Crummy

[Summary: pp 28-91]

The quantity and variety of stone architectural fragments recovered have meant that identification of each piece by a geologist would be prohibitively expensive and time-consuming. Martyn Owen of the Institute of Geological Sciences, London has kindly identified several pieces and from this basis I have described the rest. A few remain with no identification offered.

Most of the architectural fragments derive from post-Roman contexts. This is the result of the medieval robbing of the Roman levels for building stone, there being none locally. Therefore unless a fragment is obviously post-Roman or is found incorporated in a post-Roman structure, it is included here.

The following lists are in two forms. First the fragments are listed in numerical order according to their catalogue numbers as set out in CAR 2. This list also appears in fiche in CAR 2. Second the fragments are grouped according to the dates of the contexts in which the various pieces were found. In all cases the figures on the left are the catalogue numbers.

2546 SF LWC 359, A14 F6. Pit. Second half of the 17th century. Africano marble. Veneer, 6.5 mm thick. No edges.

2547 SF LWC 71, A16. Probably modern. Purbeck marble. Inscription 'DEO'. Hollow chamfer along top edge. Fig 198.

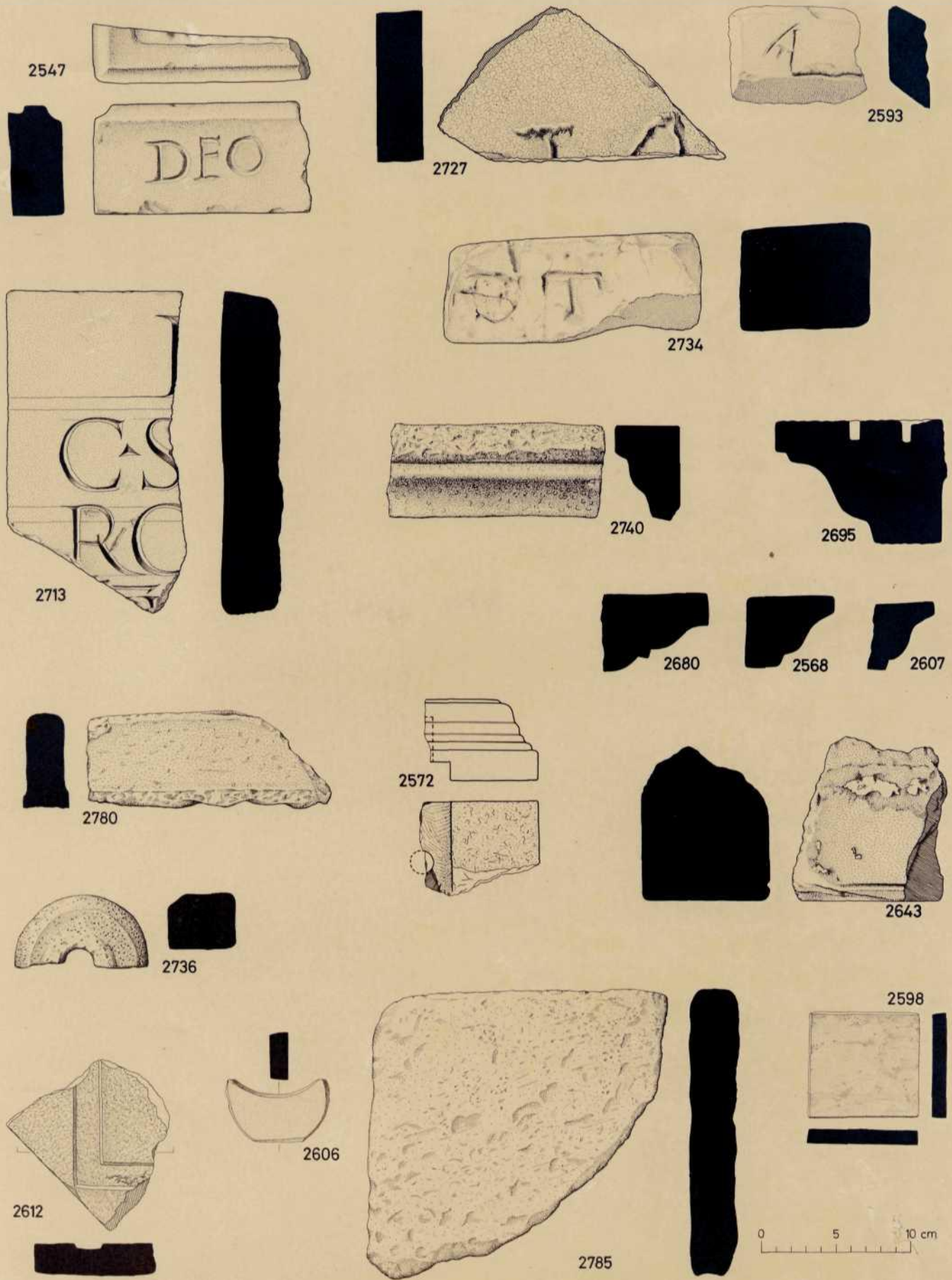


Fig 198 Inscribed, moulded, and other architectural stone fragments



- 2548 SF LWC 3666, A19. Probably modern. Imperial (red) porphyry. Veneer, 6.0 mm thick. No edges.
- 2549 SF LWC 1607, A36 F20. 15th century. Brecciated white and pink marble. Veneer, 8.5 mm thick. No edges.
- 2550 SF LWC 360, A48. Modern. Greek green porphyry. Veneer strip 6.0 mm thick, 19.0 mm wide.
- 2551 SF LWC 375, A49 F29. 16th century or later. Brecciated white and pink marble. ?Veneer. Lower surface unworked, maximum thickness 23.0 mm. No edges.
- 2552 SF LWC 1061, A64. Topsoil. Post-Roman to post-medieval. Veneer strip, 13.0 mm thick, 38.5 mm wide.
- 2553 SF LWC 1238, A79. Post-Roman to modern? Small chip of white marble. Veneer, 10.5 mm thick. No edges.
- 2554 SF LWC 1219, A81. Late Roman to early medieval. White marble. Veneer strip, 11.0 mm thick, 35.5 mm wide.
- 2555 SF LWC 1239, A96. Late Roman to early medieval. Small chip of white marble. Veneer, 8.5 mm thick. No edges.
- 2556 SF LWC 1216, A102. Post-medieval or later. Very small chip of brecciated black/green and white marble. Possibly Verde Antico. Veneer, 5.0 mm thick. No edges.
- 2557 SF LWC 1222, A103. Topsoil over tessellated pavement. Probably late Roman but possibly early medieval. Cipollino marble. Veneer, 11.0 mm thick. No edges?
- 2558 SF LWC 1223, A119. Topsoil over tessellated pavement. Probably late Roman but possibly early medieval. Strip. Hollow chamfers along all four edges. 19.0 by 11.5 mm.
- 2559 SF LWC 852, A266 F44. Robber trench. 13th century. Pavonazetto marble. Veneer, 9.0 mm thick. No edges.
- 2560 SF LWC 4344, B7 F11. Robber for gravel. Early medieval. Imperial (red)

- porphyry. Veneer ?strip, 10.0 mm thick, 37.5 mm wide.
- 2561 SF LWC 35, B23 F14. Boundary ditch. 17th century. Purbeck stone.  
Strip. Hollow chamfers along all four edges. 19.5 by 12.5 mm.
- 2562 SF LWC 232, B45 F23. Road ditch. Period 4. Purbeck marble. Veneer,  
54.5 mm thick. At least one edge.
- 2563 SF LWC 222, B74 F42. 12th to 15th century. Purbeck marble. Veneer,  
43.0 mm thick. Two edges?
- 2564 SF LWC 4053, B90. Surface cleaning. Possibly modern. Purbeck marble.  
Veneer, 25.0 mm thick. No edges.
- 2565 SF LWC 1754, B192 F74. Pit. 12th to 15th century. White marble.  
Veneer, 12.5 mm thick. Two parallel edges, 73.5 mm apart. Possibly a  
third edge.
- 2566 SF LWC 2042, B305. Floor and occupation material. Periods 3-5.  
Africano marble. Veneer, 23.0 mm thick. No edges.
- 2567 SF LWC 848, B373. Pit complex. Period 4 or 5. Pavonazzeto marble.  
Veneer strip, 7.0 mm thick. One edge chamfered. 19.0 mm wide.
- 2568 SF LWC 860, B411 F147. Pit with burnt edges. Period 5. Purbeck  
marble. Moulded ?cornice. Fig 198.
- 2569 SF LWC 1235, B606. Cellar (F70) backfill, contaminated. Period 5+.  
Purbeck (?)marble. Veneer, 31.0 mm thick. No edges.
- 2570 SF LWC 1203, B645 F70. Cellar. Period 5. Strip. Hollow chamfer along  
one edge, two others slightly grooved. 10.0 by 23.0 mm.
- 2571 SF LWC 4013, B667 F240/30. Pit. 18th to 20th century. Purbeck stone.  
Veneer, 45.5 mm thick. Lower surface rough. Edges?
- 2572 SF LWC 1135, B F70. Probably cellar backfill. Period 5. Purbeck marble.  
Moulded ?cornice with external return. Fig 198.
- 2573 SF LWC 823, C85 F49. Cesspit. 16th to 17th century. White marble.  
Veneer strip, 17.0 mm thick, 37.0 mm wide.
- 2574 SF LWC 1046, C415. Occupation. Period 3a. Rectangular section strip,

- possibly associated with mosaic manufacture.
- 2575 SF LWC 1899, D224 F129. Slot. Post-Roman. Cipollino marble. Veneer, 13.0 mm thick. Lozenge-shaped, but edges very rough. Shape could be fortuitous. 82.5 by 40.5 mm point to point.
- 2576 SF LWC 1863, D280 F163+164. Pit material. Post-Roman. Cipollino marble. Veneer, 6.0 mm thick. No edges.
- 2577 SF LWC 1392, E17. Tile spread. 17th century. Brecciated white and pink marble. Veneer, 15.0 mm thick. No edges.
- 2578 SF LWC 1335, E63. Topsoil over road. Period B or C. Brecciated white and pink marble. Veneer, 13.0 mm thick. No edges.
- 2579 SF LWC 1373, E81 (F48). Sinkage? Late Roman or Anglo-Saxon. White marble. Veneer, 7.5 mm thick. Two contiguous edges.
- 2580 SF LWC 1372, E82 F47. Slot, or crack in road? Roman or post-Roman. Africano marble. Veneer, 7.0 mm thick. No edges.
- 2581 SF LWC 1464, E84 (F49). Sinkage? Late Roman or Anglo-Saxon. White marble with black veins. Veneer, 8.5 mm thick. No edges.
- 2582 SF LWC 1375, E87 F45. Pit. 15th to 16th century. Verde Antico marble. Veneer, 13.0 mm thick. Three edges. One is complete (55.5 mm) and is slightly chamfered.
- 2583 SF LWC 2790, E144 F73. Pit? Post-medieval. Purbeck marble. Veneer, 31.0 mm thick. One edge.
- 2584 SF LWC 1554, G58 F32. Shallow pit. Period 1 or 2. Dark pink marble. Veneer strip with rounded end, 6.5 mm thick, 12.0 mm wide.
- 2585 SF LWC 1552, G61 F25. Pit. Period 4 (beginning). Cipollino marble. Veneer, 12.0 mm thick. One edge.
- 2586 SF LWC 1614, G113. Demolition debris or dump? Period 4? Brecciated white, red and purple marble. Veneer, 10.5 mm thick. No edges.
- 2587 SF LWC 3893, G436 F215. Shallow depression. Period 2. Purbeck marble. Veneer strip with mitred end, 15.0 mm thick, 39.5 mm wide.



- 2588 SF LWC 3852, G471 F237. Soakaway pit. Period 1 (or 2). White marble, with some pink, possibly as 2549. Veneer strip, 13.0 mm thick, 16.0 mm wide.
- 2589 SF LWC 3851, G481 F241. Daub-lined pit. Period 2 (or 1?). White marble, with black/purple veins. Veneer, 8.5 mm thick. No edges.
- 2590 SF LWC 4051, G516 F258. Pit. Period 2. Veneer, 19.5 mm thick. Edges? Lower surface rough.
- 2591 SF LWC 3936, G541 F272. Slot. Period 2. A brecciated white and pink marble with some black. Possibly burnt. Veneer, 19.0 mm maximum thickness. Lower surface not worked. No edges.
- 2592 SF LWC 2211, H85 F15. Robber trench. Medieval. Brecciated white, red and purple marble. Veneer ?strip, 12.5 mm thick, 36.0 mm wide.
- 2593 SF LWC 2185, H110. Topsoil. 17th century or later. Veneer, 27.0 mm thick. Two parallel chamfered edges, one grooved, 67.0 mm wide. Mason's mark scratched into undersurface.
- 2594 SF LWC 2026, H186 F32. Pit. Roman?/Anglo-Saxon?/medieval?. White and orange marble. Veneer strip of ?square section. 11.5 by 12.0 mm. One face could be a break.
- 2595 SF LWC 2027, H190 F32. Pit. Roman?/Anglo-Saxon?medieval? Fine red sandstone. Veneer strip, 8.0 mm thick, 14.0 mm wide. Lower surface rough.
- 2596 SF LWC 2139, H218 F63. Hut. Anglo-Saxon. Brecciated white and pink marble. Veneer, 7.5 mm thick. One definite edge.
- 2597 SF LWC 2305, H256 F10. Road ditch. Roman. Cipollino marble. Veneer, 20.5 mm thick. Two contiguous edges at right angles.
- 2598 SF LWC 2097, J1. Rubble. Modern. Cipollino marble. Veneer tile, 71.0 by 74.0 mm, 10.0 mm thick. Fig 198.
- 2599 SF LWC 3987, J9 F4. Post-Roman to modern. Imperial (red) porphyry. Veneer, 15.0 mm maximum thickness. Lower surface very rough.

- 2600 SF LWC 3988, J18 F19. Robber trench. Early medieval. Greek green porphyry. Veneer, 5.5 mm thick. Two contiguous edges at an obtuse angle.
- 2601 SF LWC 1809, J21 F12. Pit. Post-Roman. Dark pink marble. Moulded veneer strip, 23.5 mm thick, 45.0 mm wide. Two parallel chamfered edges.
- 2602 SF LWC 2735, J271 F83. Group of Roman roof tiles. Period 4b destruction? Carrara marble. Veneer, 18.0 mm thick. One rounded edge.
- 2603 SF LWC 2601, J327 F16. Lime pit. Early medieval. Verde Antico marble. Veneer, 10.0 mm thick. No edges.
- 2604 SF LWC 2504, J367. Period 4b demolition debris. Period 4b destruction. Fine red sandstone. Rectangular section strip, 9.5 by 12.0 mm. One surface rough.
- 2605 SF LWC 2850, J369. Period 4b demolition debris. Period 4b destruction. Purbeck marble. Veneer, 31.0 mm thick. No edges? Lower surface rough.
- 2606 SF LWC 2749, J373. Period 4b demolition debris. Period 4b destruction. Pinky-cream marble. Veneer crescent with flattened base on outer curve, 13.0 mm thick. Maximum length 69.0 mm, maximum width 43.0 mm. Fig 198.
- 2607 SF LWC 3990, J384. Destruction debris. Period 4b destruction? Purbeck marble. Moulded ?cornice. Fig 198.
- 2608 SF LWC 2481, J435 F161. Posthole. Post-Roman. Cream marble with black veins. Veneer, 5.5 mm thick. No edges.
- 2609 SF LWC 4014, J453. Make-up or floor. Period 4. Purbeck marble. Veneer, 20.0 mm thick. One edge.
- 2610 SF LWC 2748, J482. Demolition debris? Period 4b destruction? Purbeck marble. Veneer, 27.0 mm thick. One edge?
- 2611 SF LWC 2736, J518 (F184). Demolition debris. Period 4b destruction. Weathered dull buff-white marble. Veneer, 39.0 mm thick. Two opposite but not parallel edges, one with a right-angled cut-out. Lower surface rough with shallow ?dowel hole.
- 2612 SF LWC 2702, J551. Tile and gravel patch. Demolished building? Period

- 5, or late Roman, or later. Purbeck marble. Veneer, 21.0 mm thick. One edge. Right-angled groove with sloping sides for inlay, 4.0 mm deep, varying from 15.5 to 19.0 mm across. Fig 198.
- 2613 SF LWC 2703, J551. Tile and gravel patch. Demolished building? Period 5, or late Roman, or later. Purbeck marble. Veneer, 28.5 mm thick. No edges.
- 2614 SF LWC 2911, J588. Tile and gravel surface of footway. Period 4. Purbeck marble. Possibly part of a column or sculpture.
- 2615 SF LWC 2864, J627. First gravelled surface of yard. Period 4a. Purbeck marble. Veneer, 31.0 mm thick. Three edges, 168.0 mm along complete edge, maximum surviving length of the other dimension 134.0 mm. Lower surface rough. Dowel hole.
- 2616 SF LWC 3070, J838 F119. Foundation. Period 4. Purbeck marble. Veneer, 37.0 mm thick. Two contiguous edges at right angles. Lower surface rough.
- 2617-18 SF LWC 3184, J951. Make-up. Period 3. Two pieces of Purbeck marble veneer. 2617) 24.0 mm thick. One edge. 2618) 28.5 mm thick. One edge.
- 2619-20 SF LWC 3327, J981. Make-up. Period 3. Two pieces of Purbeck marble veneer. 2619) 29.0 mm thick. One edge. 2620) 28.0 mm thick. No edges.
- 2621 SF LWC 3275, J981. Make-up. Period 3. Purbeck marble. Veneer. Upper surface partly sunk. 22.0 to 26.5 mm thick.
- 2622 SF LWC 3276, J987. Make-up. Period 3. Africano marble. Veneer, 26.0 mm thick. Two contiguous edges at right angles.
- 2623-26 SF LWC 3291, J992 F315. Timber-lined and burnt drain. Period 2. Four pieces of Purbeck marble veneer. 2623) 24.0 mm thick. No edges. 2624) 18.0 mm thick. Two contiguous edges at right angles. 2625) 19.0 mm thick. Two contiguous edges at right angles. Broken across a dowel hole. 2626) 27.0 mm thick. One edge.
- 2627 SF LWC 3535, J1086. Make-up (redeposited from earlier levels?).



- Period 4. Purbeck marble. ?Worked.
- 2628 SF LWC 3058, K227. Medieval or later. Purbeck marble. Veneer, 17.0 mm thick. No edges. Lower surface rough.
- 2629 SF LWC 3109, K239. ?Garden soil. Period 4? Or post-Roman? ?Verde Antico marble. Veneer, 11.5 mm thick. Two opposite, not quite parallel, edges.
- 2630 SF LWC 3956, K255 F126. Pit. Medieval or later? White ?marble. Veneer, 25.5 mm thick. No edges.
- 2631-2 SF LWC 3108, K255 F126. Pit. Medieval or later? White ?marble. Two pieces of veneer 2631) 24.0 mm thick. No edges. 2632) 24.0 to 26.0 mm thick. No edges.
- 2633 SF LWC 3667, K367. Garden topsoil. Period 4b. Africano marble. Veneer, 21.5 mm thick. No edges.
- 2634 SF LWC 3751, K415. ?Base of topsoil or make-up of Period 3. Period 3 or 4b. Africano marble. Veneer, 25.0 mm thick. ?One edge.
- 2635 SF LWC 2673, L120 F81. Pit. Period 5 or 6. Creamy-pink marble. Veneer, 10.0 mm thick. One edge.
- 2636 SF LWC 4245, L181. Topsoil. Post-medieval. Cipollino marble. Veneer strip, rectangular section, 11.0 by 8.5 mm. One face broken.
- 2637-8 SF LWC 2895, L280 F142. Shallow scoop. Period 5? 2637) Purbeck marble. Veneer strip, 14.0 mm thick, 40.5 mm wide. One end mitred. 2638) White marble. Veneer, moulded. Thickness to top of moulding 15.0 mm. No edges.
- 2639 SF LWC 2933, L294 F81. Pit. Period 5 or 6. Veneer strip, rectangular section, 14.0 by 11.0 mm. One face broken.
- 2640 SF LWC 4015, L379 F241. ?Oven. Period 4(2). Purbeck marble. Veneer, 44.5 mm thick. ?Four edges, 77.0 by 78.5 mm.
- 2641 SF LWC 3295, L406. Make-up/dump. Period 4(1). Purbeck marble. Veneer. Split, therefore thickness unknown. No edges.

- 2642 SF LWC 3352, L440 F261. Robber trench. Period 5. Purbeck marble.  
Veneer, 33.0 mm thick. Four edges, 118.0 by 120.0 mm.
- 2643 SF LWC 3367, L440 F261. Robber trench. Period 5. Purbeck marble.  
Possibly part of a column or sculpture. Fig 198.
- 2644 SF LWC 3395, L456. Cultivated soil. Period 2 + 3a. Pink marble.  
Veneer, section tapers from 10.0 to 7.0 mm thick. Edges?
- 2645 SF LWC 3989, M62. Rampart 2? Purbeck marble. Slab. Possibly from town  
wall. Opus signinum on all but two faces, which appear to be later  
breaks.
- 2646 SF LWC 3221, M109. Rampart 1d. Purbeck marble. Veneer, 21.5 mm thick.  
At least one edge.
- 2647 SF LWC 3965, R4. Topsoil and machine clearance. Post-Roman. A  
decorative granite. Veneer, 11.0 mm thick. No edges.
- 2648-50 SF LWC 4050, R4. Topsoil and machine clearance. Post-Roman. Dull  
cream marble. Three pieces of veneer. 2648) 7.5 mm thick. No edges.  
2649) 7.0 mm thick. No edges? 2650) 7.0 mm thick. One ?chamfered edge.
- 2651 SF LWC 3782, R21 F18. Trench. Post-Roman. Shelly Purbeck stone.  
Wedge-shaped fragment. Lower surface rough. Maximum thickness 53.0 mm.  
Edges?
- 2652 SF LWC 3924, R23. Metalling. Period 4b. Purbeck stone. Veneer,  
25.0 mm thick. At least two contiguous edges, at a slightly obtuse angle.
- 2653-6 SF LWC 3896, R83 F47. Robber trench? Post-Roman. Four small pieces  
of veneer. 2653) Creamy marble. 8.0 mm thick. Two contiguous edges at  
an acute angle. 2654) Brecciated white and dark purple marble. 6.5 mm  
thick. No edges. 2655) ?Africano marble. 11.0 mm thick. No edges.  
2656) Greek green porphyry. 11.0 mm thick. Two parallel edges? 28.0 mm  
wide.
- 2657 SF LWC 3917, R127 F58. Robber trench. Period 4b. Purbeck marble.  
Rectangular section strip, 34.5 by 36.0 mm.



- 2658 SF LWC 3937, R164 F70. Pit. Period 4. Cipollino marble. Veneer, 23.0 mm thick. One edge.
- 2659 SF BKC 311, A72 F16. Town ditch fill. Anglo-Saxon or Period 6. Dull white marble with some red/orange veins. Veneer, 17.5 mm thick. One edge.
- 2660 SF BKC 314, A72 F16. Town ditch fill. Anglo-Saxon or Period 6. Purbeck marble. Veneer, 18.5 mm thick. No edges.
- 2661 SF BKC 827, A86 L4. Topsoil and town ditch (F19) fill. Post-Roman. Black and white brecciated marble. Veneer, 18.0 mm thick. No edges.
- 2662 SF BKC 486, A90 F16. Town ditch fill. Anglo-Saxon or Period 6. Cipollino marble. Veneer, 12.5 mm thick. One edge?
- 2663 SF BKC 1749, A116 (L17). In F39 fortress ditch. Period 1. Purbeck marble. Veneer, 21.5 mm thick. No edges?
- 2664 SF BKC 810, D171 L2. Town ditch fill. Anglo-Saxon. Purbeck marble. Veneer, 36.0 mm thick. No edges?
- 2665 SF BKC 826, D184 L2. Town ditch fill. Anglo-Saxon. Greek green porphyry. Veneer, 4.5 mm thick. One edge.
- 2666 SF BKC 1871, D205. Town ditch fill. Late Period 6 or Anglo-Saxon. Purbeck marble. Veneer, 15.5 mm thick. One rough edge with ?dowel hole. Lower surface rough.
- 2667 SF BKC 1753, D243 F13/L13. Town ditch fill. Anglo-Saxon. Purbeck marble. Veneer, 34.5 mm thick. No edges. Lower surface rough.
- 2668 SF BKC 1750, D290 L16. Town ditch fill. Anglo-Saxon. Purbeck marble. Veneer, 23.5 mm thick. One edge. Lower surface very rough.
- 2669 SF BKC 5850, D367. Town ditch fill. Late Period 6 or Anglo-Saxon. Dark pink marble. Veneer strip, 12.5 mm thick, 17.5 mm wide. Both ends survive, one is mitred. Maximum length to tip of mitred corner, 85.0 mm.
- 2670 SF BKC 1751, D372. Town ditch fill. Late Period 6 or Anglo-Saxon. White, pink and orange brecciated marble. Veneer, 14.5 mm thick. Two

contiguous edges at right angles.

- 2671 SF BKC 5096, D388. Town ditch fill. Late Period 6 or Anglo-Saxon. Veneer, 24.0 mm thick. One edge. Lower surface rough.
- 2672 SF BKC 1752, D unstratified. Purbeck marble. Veneer, 38.0 mm thick. One edge, roughly chamfered.
- 2673 SF BKC 1801, E140 F24. Gravel pit. Post-Roman. Purbeck marble. Veneer, 13.5 mm thick. One edge.
- 2674 SF BKC 6065, E205 F27. Backfill of robbed pier base. Period 6. Purbeck marble. ?Veneer, probably reused (mortared on polished surface), 33.0 mm thick. Lower surface very rough. No edges.
- 2675 SF BKC 1450, E230 L31. Make-up. Period 5. ?Carrara marble. Veneer, 29.0 mm thick. One edge.
- 2676 SF BKC 1663, E242 F92/A. Backfill of robbed pier base. Period 6. Purbeck marble. Veneer, 15.5 mm thick. No edges? Lower surface rough.
- 2677 SF BKC 1284, E280 L445. Town ditch (F138) fill. Late Period 6 or Anglo-Saxon. Dark pink marble. Veneer strip, 14.0 mm thick, 21.0 mm wide. One mitred end survives. Maximum length to tip of mitred corner 91.0 mm.
- 2678 SF BKC 1383, E302 L447. Town ditch (F138) fill. Late Period 6 or Anglo-Saxon. Cipollino marble. Veneer, 13.0 mm thick. No edges. Lower surface rough.
- 2679 SF BKC 1652, E475 L130. Make-up. Period 5. Purbeck marble. Veneer, 19.0 mm thick. No edges.
- 2680 SF BKC 5097, E769 F227. Pit. Period 6. Purbeck marble. Moulded ?cornice.
- 2681 SF BKC 2012, E1286 F432, contaminated. Period 5 to modern. Creamy-white marble. Veneer, 24.0 mm thick. One edge, perhaps another.
- 2682 SF BKC 2210, G101 F11. Timber-lined drain. Period 5c. Greek green porphyry. Veneer, 4.0 mm thick. Two contiguous edges.

- 2683 SF BKC 5098, G349. Uncertain. Period 5? Veneer, 28.0 mm thick. One edge.
- 2684 SF BKC 5047, G392. Backfill in pipe trench(es). Period 3 or 2. Purbeck marble. Veneer, triangular section, maximum dimensions 73.0 by 43.5 by 60.0 mm.
- 2685 SF BKC 2461, G401 F11. Timber-lined drain. Period 5c. Purbeck marble. Veneer (brick-shaped), 70.0 mm maximum thickness, 139.5 mm wide. One end survives. One side face is moulded. Lower surface is covered with marks of a walling hammer (Hodges 1976, fig 23, 1).
- 2686 SF BKC 5841, H14 L2. Topsoil. Modern. Purbeck marble. Veneer, 13.5 mm thick. No edges.
- 2687 SF BKC 5836, H104 F34? Post-medieval? Veneer, 15.0 mm thick. Two contiguous edges at right angles.
- 2688 SF BKC 5839, H104 F34? Post-medieval? Pink marble. Veneer, 20.5 mm thick. One edge.
- 2689 SF BKC 5046, H263 F68. Hearth over pit. Period 5c. Imperial (red) porphyry. Veneer, 21.0 mm thick. No edges.
- 2690 SF BKC 4905, J83 L16. Dump. Period 3/4/5a. Purbeck marble. ?Two worked faces.
- 2691 SF BKC 4907, J167. Unstratified. Strip, rectangular section, 16.0 by 28.0 mm. Tapering groove along one edge.
- 2692 SF BKC 4904, J176 F32. Pit. Period 5c/6. Veneer, 18.0 mm thick. Two contiguous edges at right angles. Lower surface rough.
- 2693 SF BKC 5101, J183 F41. Pit. Period 5b (or 5c/6). Veneer, 14.5 mm thick. Edges?
- 2694 SF BKC 5837, J183 F41. Pit. Period 5b (or 5c/6). Veneer, 15.0 mm thick. No edges.
- 2695 SF BKC 5221(ii), J214 F50. Pit and midden. Period 5c/6. Purbeck marble. Moulded ?cornice. Fig 198.



- 2696 SF BKC 5044, J218. Pit material. Modern or Period 5-6? Purbeck marble. Veneer, 22.0 mm maximum thickness. One edge. Lower surface very rough.
- 2697 SF BKC 5084, J238 F13. Large pit. Period 5b. Pavonazetto marble. Veneer, 14.0 mm thick. Edges?
- 2698 SF BKC 5080, J273. Period 4 or 5c/6. Purbeck marble. Veneer (in two fragments), 47.5 mm maximum thickness. Three edges, one complete, 282.0 mm long. Maximum surviving length of the other dimension 163.5 mm.
- 2699 SF BKC 5085, K69 L1. Overburden. Modern. Veneer strip, square section, 27.0 by 26.5 mm.
- 2700 SF BKC 5078, K103 F12. Robber trench. Modern. Purbeck marble. Veneer, 33.0 mm thick. No edges.
- 2701 SF BKC 5158, K108 F13. Pit. Modern. Africano marble. Veneer, 10.0 mm thick. One edge.
- 2702 SF BKC 5088, K208 F36. Pipe trench. Modern. ?Veneer, no faces, but two contiguous edges at right angles.
- 2703 SF BKC 6064, K240 F44. Pit. Modern. Purbeck marble. Veneer, 22.5 mm thick. One chamfered edge. Upper surface weathered, lower rough.
- 2704 SF BKC 5077, K246 F15. Gully/ditch. Period 6. Purbeck marble. Veneer, 30.0 mm thick. One rough edge, possibly another.
- 2705 SF BKC 5081, K257 F50. Pit. Modern. Creamy-pink marble. Veneer, 15.0 mm thick. One edge. Lower surface rough.
- 2706 SF BKC 5079, K323 L26. Make-up. Period 4c. Purbeck marble. Veneer, 44.5 mm thick. One chamfered edge. Lower surface rough.
- 2707 SF BKC 6047, K415 L69. Dump. Period 5/6. Veneer, 17.5 mm thick. One edge?
- 2708 SF BKC 5086, K436 L78 (F113). Modern. Pavonazetto marble. Veneer, 12.0 mm thick. Two edges.
- 2709 SF BKC 3568, K442 L60. Make-up or dump. Period 5/6. Purbeck marble. Veneer, 8.5 mm thick. One chamfered edge.

- 2710 SF BKC 5082, K521 L119. Dump/make-up. Period 4a/b. Brecciated white and dark purple marble. Veneer, 11.5 mm thick. No edges.
- 2711 SF BKC 6039, M28. Periods 3/4-6. Purbeck marble. Veneer, section split. No edges.
- 2712 SF BKC 6050, M28. Periods 3/4-6. Purbeck marble. Veneer, 14.5 mm thick. No edges?
- 2713 SF BKC 4106, N19. Period 6. Dull white marble. Veneer, 40.0 mm thick. Two contiguous edges at right angles. Lower surface rough. Inscribed. Fig 198. This piece was described in its preliminary publication (Hassall & Tomlin 1977, 427-8, no 8) as probably being from a funerary monument but since the find spot is not within or near to a cemetery, this is uncertain.
- 2714 SF BKC 5220, N19. Period 6. Purbeck marble. Veneer, 32.0 mm thick. No edges.
- 2715 SF BKC 5340, N22 L1. Topsoil. Modern. White-grey marble. Veneer, 13.0 mm thick. One edge?
- 2716 SF BKC 5219, N65. Period 5 or 6? Pinky-cream marble with black veins. Veneer, 18.5 mm thick. No edges. (Fits 2720.)
- 2717 SF BKC 5316, N85 L3. Topsoil. Period 6. Brecciated white and dark purple marble. Veneer, 13.0 mm thick. One edge.
- 2718 SF BKC 5220(ii), N103. Period 5 or 6. Purbeck marble. Veneer, 30.0 mm thick. No edges.
- 2719 SF BKC 5313, N233 F84. Pit. Period 6. Veneer strip, rectangular section, 17.0 by 27.5 mm. Hollow chamfers on two edges, slight plain chamfers on the other two.
- 2720 SF BKC 5317, N314 F97. Trench/slot. Period 5b2. Pinky-cream marble with black veins. Veneer, 20.0 mm thick. At least one edge. (Fits 2716.)
- 2721 SF BKC 5339, N321. Surface cleaning. Modern. Purbeck marble. Veneer,



- 32.5 mm thick. Three edges, one complete 123.5 mm long. Maximum surviving length of the other dimension 66.0 mm. Lower surface uneven but smooth, possibly keyed.
- 2722 SF BKC 5341, N633 L59. Dump. Period 5b2. Purbeck marble. Veneer (in two fragments), thickness varies from 32.5 to 36.0 mm. Two contiguous edges.
- 2723 SF BKC 5360, N644 F113. Slot. Period 5b2. Purbeck marble. Veneer, 53.0 mm thick. One edge. Upper surface weathered, lower rough.
- 2724 SF BKC 6040, P12 F3. Robber trench. Period 6. Brecciated white and dark purple marble. Veneer, 12.5 mm thick. One edge.
- 2725 SF BKC 5318, T111 L33. Destruction debris of Period 2. Period 3. ?Cornice fragment.
- 2726 SF BKC 5298, T207. Destruction debris. Period 2. Pavonazetto marble. Veneer, 7.5 mm thick. One chamfered edge.
- 2727 SF BKC 5301, T223 F99. Uncertain. Purbeck marble. Veneer, 31.0 mm thick. No edges. Inscribed. Fig 198.
- 2728 SF BKC 5302, T223 F99. Uncertain. Purbeck marble. Veneer, 20.0 mm thick. One edge. Lower surface rough.
- 2729 SF BKC 5299, T617. Period 1 or 2. Africano marble. Veneer, 19.0 mm thick. No edges.
- 2730 SF BKC 6049, V71. Unstratified. Greek green porphyry. Veneer, 7.0 mm thick. One edge.
- 2731 SF BKC 6052, V240 L46. Make-up? Period 5. Purbeck marble. Veneer, 26.0 mm thick. No edges.
- 2732 SF BKC 6046, V385 F28/89. Pit. Period 5, 6, or modern. Purbeck marble. Veneer, 27.0 mm thick. No edges. Lower surface very rough.
- 2733 SF BKC 6048, V563 L59. Dump. Period 4. White marble. Veneer, 14.5 mm thick. Two edges?
- 2734 SF BKC 6028, V727. Unstratified. Chalk. Veneer (brick-shaped

- fragment), 90.0 mm thick. Upper face inscribed. ?Mason's marks on lower face. Fig 198.
- 2735 SF BKC 6054, V727. Unstratified. Purbeck marble. Moulded veneer.
- 2736 SF BKC 6053, V731 F185. Pit. Modern (post-medieval?). ?Pilaster fragment. Fig 198.
- 2737 SF BKC 6051, V809 F252. Ditch. Period 2. Pinky-cream marble. Veneer, 23.0 mm thick. No edges.
- 2738 SF BKC 6057, V813 L22. Dump. Late Period 5. Purbeck marble. Small fragment of one surface. ?Veneer, 99.5 mm thick. No edges.
- 2739 SF BKC 6058, V932 L11. Dump. Late Period 5. White marble with some pink and orange, and grey veins. Veneer, 14.0 mm thick. Two opposite but not parallel edges.
- 2740 SF BKC 6062, V1070 F423. Postpit. Period 4. Purbeck marble. Moulded ?cornice. Fig 198.
- 2741 SF BKC 6056, V1114 F434+F437. Period 4. Purbeck marble. Veneer, 41.0 mm thick. Edges? Lower surface rough.
- 2742 SF BKC 6059, V1140 F441. Post pit with posthole. Period 4. Veneer, 20.5 mm maximum thickness. Moulded upper surface, lower surface rough.
- 2743 SF BKC 6060, V1262. Unstratified. Periods 2 to 6? Purbeck marble. Veneer, 26.5 mm thick. One edge.
- 2744 SF BKC 6061, V1279 F497. Pit. Period 2. Greenstone. Veneer, section split. One edge.
- 2774 SF MID 18, A49 F22. Pit. Post-medieval to modern. Purbeck stone. Veneer, 15.0 mm thick. One edge.
- 2775 SF MID 430, A145 F36. Pit. Post-medieval to modern. Purbeck marble. Veneer (in two fragments), from 12.0 to 24.0 mm thick. Three rough edges, one complete 175.0 mm long. Maximum surviving length of the other dimension, 85.5 mm. Lower surface rough.
- 2776 SF MID 26, B152 L4. Topsoil. 4th century or later. Purbeck marble.

- Veneer, 18.0 mm thick. Three edges, none complete.
- 2777 SF MID 39, A160 L5. Topsoil. 4th century or later. Greek green porphyry. Veneer, 6.5 mm thick. No edges.
- 2778 SF MID 59, A270 F64. Pit. Post-medieval to modern. White marble. Veneer strip, one face rough, 14.5 by 14.5 mm.
- 2779-80 SF MID 146, C476 F159. Gully. Period 3 destruction or later Roman. Furbeck marble. 2779) Veneer (in two fragments), 14.0 mm thick. No edges. 2780) Flange? Rectangular, with one rounded edge (?top), and traces along the length of the base of one large face of a projection at right angles to the plane of the face. Possibly from a gutter. 25.5 mm thick, 61.5 mm high. Fig 198.
- 2781 SF MID 120, C480 F160. Shallow pit. 2nd century to early medieval. Furbeck marble. Veneer strip, 12.5 mm thick, 36.0 mm wide. Mitred.
- 2782 SF MID 143, C483 L26. Site clearance, mainly topsoil. Modern. Furbeck marble. Veneer, 17.0 mm thick. One edge. Lower surface rough.
- 2783 SF MID 205, C542 L25. Topsoil accumulation of Site C Phase 2. Furbeck marble. Veneer, 33.0 mm thick. One edge.
- 2784 SF MID 215, A739 F25. Robber trench. Early medieval. Furbeck marble. Veneer, 17.5 mm thick. No edges.
- 2785 SF MID 246, A878 L598. Site clearance in A north. (Mainly topsoil, with modern material.) Furbeck marble. Veneer, 41.0 mm thick. Lower surface rough. All edges intact, quarter circle in shape. Fig 198.
- 2786 SF MID 268, C1018 F323. Pit. Site C Phase 1. Furbeck marble. Veneer, 16.0 mm thick. No edges.
- 2787 SF MID 299, C1141 L143. Metalling of Site C Phase 2 backyard. White marble. Veneer, 9.0 mm thick. Edges?
- 2788 SF MID 573, A1244 F43. Pit. Post-medieval to modern. White marble. Veneer, 8.5 mm thick. Three edges, one complete 41.5 mm long. Maximum surviving length of the other dimension, 25.0 mm.



- 2789 SF MID 352, A1268 F399. Robber trench. Early medieval. Purbeck marble. Veneer, 10.5 mm thick. No edges.
- 2790 SF MID 355, A1322 F44. Robber trench. Early medieval. Purbeck marble. Veneer, 15.0 mm thick. Two contiguous edges at right angles.
- 2791 SF MID 354, A1332 F38. Robber trench. Early medieval. Cipollino marble. Veneer, 14.0 mm thick. One edge?
- 2792 SF MID 414, C1504 L213. Patch of charcoal. Site C Phase 1. Purbeck marble. Veneer, 36.5 mm thick. At least two edges.
- 2793 SF MID 422, B1651 L215. Demolition debris. Period 3 destruction. Pavonazetto marble. Veneer strip, 13.5 mm thick, 35.0 mm wide.
- 2794 SF MID 511, A1668 F495. Kiln. 12th century. White marble. Veneer strip, 8.0 by 10.0 mm.
- 2795 SF MID 830, B1691 L223. Topsoil. Period 3 to early medieval. Purbeck marble. Veneer, 33.0 mm thick. At least one edge.
- 2796 SF MID 831, B1691 L223. Topsoil. Period 3 to early medieval. Purbeck marble. Veneer, 14.5 mm thick. Edges?
- 2797 SF MID 526, B1725 F508. Post-medieval floor and pit. Purbeck marble. Veneer, 32.0 mm thick. One edge? Lower surface rough.
- 2798 SF MID 468, A1753 F44. Robber trench. Early medieval. Carrara marble. Veneer strip, 12.5 by 17.0 mm.
- 2799 SF MID 460, C1766 F490. Pit. Early medieval. Purbeck marble. Veneer, 10.5 mm thick. One edge.
- 2800 SF MID 450, A1812 L228. Demolition debris. Period 3 demolition. Purbeck marble. Veneer, 19.5 mm thick. No edges.
- 2801 SF MID 609, A1844 F554. Gully. Medieval? White marble. Veneer, 22.5 mm thick. One edge.
- 2802 SF MID 525, C1885 F349. Kiln. 12th century. Purbeck marble. Veneer, 15.5 mm thick. No edges.
- 2803 SF MID 566, C2083 L21. Site clearance, mainly topsoil. Site C Phases 4

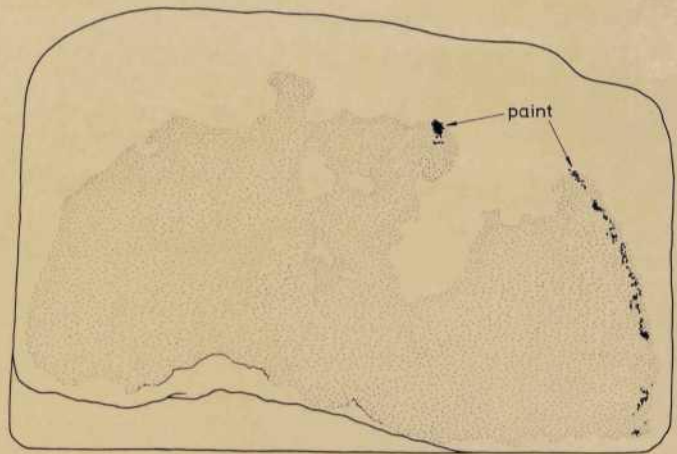
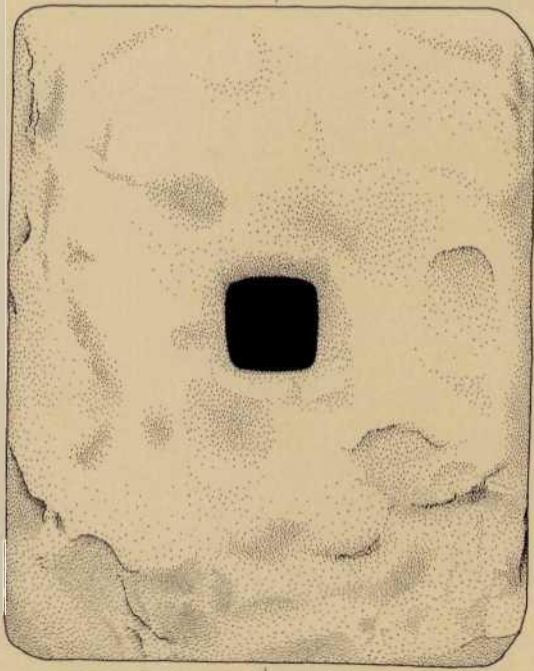
and 5. Purbeck marble. Veneer, 17.0 mm thick. No edges?

- 2804 SF MID 594, G2160 (F416?). Early medieval robber trench. Purbeck marble. Veneer, 39.0 mm thick. Two edges, both rough.
- 2805 SF MID 668, G2167 L239. Demolition debris. Period 3 destruction. Base for ?pilaster (see p 163). Traces of paint. Fig 199.
- 2806 SF MID 648, A2476. Unstratified, but medieval or later context. Veneer, 22.0 mm thick. Two opposite and parallel edges.
- 2807 SF MID 678, E2563 L389. Metalling of backyard. Site E Phase 2. Purbeck marble. Veneer, section split. No edges.
- 2808 SF MID 712, A2725 L263. Demolition debris. Period 3. Strip, possibly associated with mosaic manufacture.
- 2809 SF MID 829, A3011 L445. Demolition debris of Period 3 hypocaust. Purbeck marble. Veneer, 44.5 mm thick. One edge?
- 2810 SF MID 727, E3066 L428. Metalling. Medieval but pre Site E Phase 1. Purbeck marble. Veneer, 11.5 mm thick. No edges.
- 2811 SF MID 828, A3372 F1023. Pit. Period 1. Purbeck marble. Veneer, 32.5 mm thick. One edge.

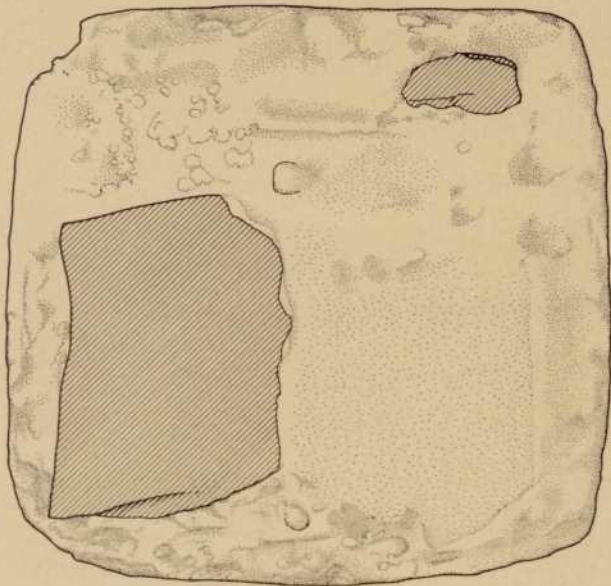
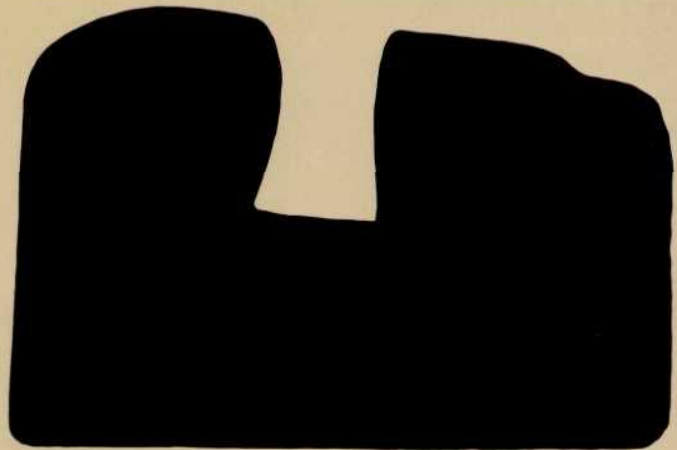
#### Concrete and tile column fragment

SF MID 792, G2830. Demolition debris. Period 3 destruction. A rectangular piece of concrete into which is set a fragment of a flat tile. Possibly from a column (see p 163). Fig 199.

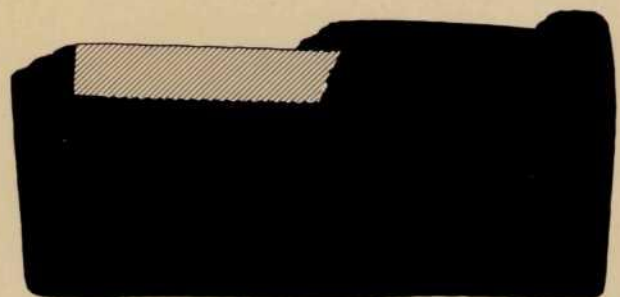




2805



SF792



0 10 20 cm

Fig 199 Two architectural fragments from Middleborough

**The stone architectural fragments listed by period****LION WALK****Period 2**

2623 J992 F315. Timber-lined and burnt drain. Purbeck marble veneer.

2624 J992 F315. Timber-lined and burnt drain. Purbeck marble veneer.

2625 J992 F315. Timber-lined and burnt drain. Purbeck marble veneer.

2626 J992 F315. Timber-lined and burnt drain. Purbeck marble veneer.

**Periods 2 to 3**

2644 L456. Cultivated soil. Pink marble veneer.

**Period 3 (Periods 3 & 4 on Site B)**

2562 B45 F23. Road ditch. Purbeck marble veneer.

2574 C415. Occupation. ?Veneer strip. Stone unidentified.

2617 J951. Make-up. Purbeck marble veneer.

2618 J951. Make-up. Purbeck marble veneer.

2619 J981. Make-up. Purbeck marble veneer.

2620 J981. Make-up. Purbeck marble veneer.

2621 J981. Make-up. Purbeck marble veneer.

2622 J987. Make-up. Africano marble veneer.

**Periods 3 to 4 (Periods 3 to 5 on Site B)**

2566 B305. Floor and occupation material. Africano marble veneer.

2567 B373. Pit complex. Pavonazetto marble veneer strip.

2634 K415. ?base of topsoil or make-up of Period 3. Africano marble veneer.

Period 4 (Period 5 on Site B; Periods 4 & 5 on Site J)

2568 B411 F147. Pit with burnt edges. Purbeck marble moulded ?cornice.  
Fig 198.

2569 B606 (F70). Cellar backfill, contaminated. Purbeck (?)marble veneer.

2570 B645 F70. Cellar. Veneer strip. Stone unidentified.

2572 B F70. Probably cellar backfill. Purbeck marble moulded ?cornice with  
external return. Fig 198.

2602 J271 F83. Group of Roman roof tiles. Carrara marble veneer.

2604 J367. Period 4b demolition debris. Fine red sandstone veneer strip.

2605 J369. Period 4b demolition debris. Purbeck marble veneer.

2606 J373. Period 4b demolition debris. Pinky-cream marble veneer crescent.  
Fig 198.

2607 J384. Destruction debris. Purbeck marble moulded ?cornice. Fig 198.

2609 J453. Make-up or floor. Purbeck marble veneer.

2610 J482. Demolition debris? Purbeck marble veneer.

2611 J518 (F184). Demolition debris. Dull buff-white marble veneer.

2612 J551. Tile and gravel patch. Demolished building? Purbeck marble  
veneer with groove for inlay. Fig 198.

2613 J551. Tile and gravel patch. Demolished building? Purbeck marble  
veneer.

2614 J588. Tile and gravel surface of footway. Purbeck marble, possibly part  
of a column or sculpture.

2615 J627. First gravelled surface of yard. Purbeck marble veneer.

2616 J838 F119. Foundation. Purbeck marble veneer.

2627 J1086. Make-up (redeposited from earlier levels?). Purbeck marble,



?worked.

- 2629 K239. ?Garden soil. ?Verde Antico marble veneer.
- 2633 K367. Garden topsoil. Africano marble veneer.
- 2640 L379 F241. ?Oven. Purbeck marble veneer.
- 2641 L406. Make-up/dump. Purbeck marble veneer.
- 2645 M62. Rampart 2? Purbeck marble slab. Possibly from town wall.
- 2646 M109. Rampart 1d. Purbeck marble veneer.
- 2652 R23. Metalling. Purbeck stone veneer.
- 2657 R127 F58. Robber trench. Purbeck marble veneer strip.
- 2658 R164 F70. Pit. Cipollino marble veneer.

#### Roman

- 2597 H256 F10. Road ditch. Cipollino marble veneer.

#### Roman or Post-Roman

- 2554 A81. White marble veneer.
- 2555 A96. White marble veneer.
- 2557 A103. Topsoil over tessellated pavement. Cipollino marble veneer.
- 2558 A119. Topsoil over tessellated pavement. ?Veneer strip. Stone unidentified.
- 2579 E81 (F48). Sinkage? White marble veneer.
- 2580 E82 F47. Slot, or crack in road? Africano marble veneer.
- 2581 E84 (F49). Sinkage? Veneer of white marble with black veins.
- 2594 H186 F32. Pit. White and orange marble veneer strip.
- 2595 H190 F32. Pit. Fine red sandstone veneer strip.

## Post-Roman

- 2546 A14 F6. Pit. Africano marble veneer.
- 2547 A16. Purbeck marble veneer. Inscribed 'DEO'. Hollow chamfer along top edge. Fig 198.
- 2548 A19. Imperial (red) porphyry veneer.
- 2549 A36 F20. Brecciated white and pink marble veneer.
- 2550 A48. Greek green porphyry veneer.
- 2551 A49 F29. Brecciated white and pink marble veneer.
- 2552 A64. Topsoil. Veneer strip. Stone unidentified.
- 2553 A79. White marble veneer.
- 2556 A102. Small chip of brecciated black/green and white marble veneer, possible Verde Antico.
- 2559 A266 F44. Robber trench. Pavonazetto marble veneer.
- 2560 B7 F11. Robber for gravel. Imperial (red) porphyry veneer ?strip.
- 2561 B23 F14. Boundary ditch. Purbeck stone veneer strip.
- 2563 B74 F42. Purbeck marble veneer.
- 2564 B90. Surface cleaning. Purbeck marble veneer.
- 2565 B192 F74. Pit. White marble veneer.
- 2571 B667 F240/30. Pit. Purbeck stone veneer.
- 2573 C85 F49. Cesspit. White marble veneer strip.
- 2575 D224 F129. Slot. Cipollino marble veneer.
- 2576 D280 F163+F164. Pit material. Cipollino marble veneer.
- 2577 E17. Tile spread. Brecciated white and pink marble veneer.
- 2578 E63. Topsoil over road. Brecciated white and pink marble veneer.
- 2582 E87 F45. Pit. Verde Antico marble veneer.
- 2583 E144 F73. Pit? Purbeck marble veneer.
- 2584 G58 F32. Shallow pit. Dark pink marble veneer.
- 2585 G61 F25. Pit. Cipollino marble veneer.



- 2586 G113. Demolition debris or dump? Brecciated white, red and purple marble veneer.
- 2587 G436 F215. Shallow depression. Purbeck marble veneer strip.
- 2588 G471 F237. Soakaway pit. Veneer strip of white marble with some pink.
- 2589 G481 F241. Daub-lined pit. Veneer of white marble with black/purple veins.
- 2590 G516 F258. Pit. Veneer. Stone unidentified.
- 2591 G541 F272. Slot. Veneer of brecciated white and pink marble with some black (possibly burnt).
- 2592 H85 F15. Robber trench. Brecciated white, red and purple marble veneer.
- 2593 H110. Topsoil. Veneer. Stone unidentified. Fig 198.
- 2596 H218 F63. Anglo-Saxon hut. Brecciated white and pink marble veneer.
- 2598 J1. Rubble. Cipollino marble veneer tile. Fig 198.
- 2599 J9 F4. Imperial (red) porphyry veneer.
- 2600 J18 F19. Robber trench. Greek green porphyry veneer.
- 2601 J21 F12. Pit. Dark pink marble moulded veneer strip.
- 2603 J327 F16. Lime pit. Verde Antico marble veneer.
- 2608 J435 F161. Posthole. Veneer of cream marble with black veins.
- 2628 K227. Purbeck marble veneer.
- 2630 K255 F126. Pit. White ?marble veneer.
- 2631 K255 F126. Pit. White ?marble veneer.
- 2632 K255 F126. Pit. White ?marble veneer.
- 2635 L120 F81. Pit. Creamy-pink marble veneer.
- 2636 L181. Topsoil. Cipollino marble veneer strip.
- 2637 L280 F142. Shallow scoop. Purbeck marble veneer strip.
- 2638 L280 F142. Shallow scoop. White marble moulded veneer.
- 2639 L294 F81. Pit. Veneer strip. Stone unidentified.
- 2642 L440 F261. Robber trench. Purbeck marble veneer.
- 2643 L440 F261. Robber trench. Purbeck marble, possibly part of a column or

sculpture, Fig 198.

- 2647 R4. Topsoil and machine clearance. Decorative granite veneer.  
2648 R4. Topsoil and machine clearance. Dull cream marble veneer.  
2649 R4. Topsoil and machine clearance. Dull cream marble veneer.  
2650 R4. Topsoil and machine clearance. Dull cream marble veneer.  
2651 R21 F18. Trench. Shelly Purbeck stone ?veneer.  
2653 R83 F47. Robber trench? Creamy marble veneer.  
2654 R83 F47. Robber trench? Brecciated white and dark purple marble veneer.  
2655 R83 F47. Robber trench? ?Africano marble veneer.  
2656 R83 F47. Robber trench? Greek green porphyry veneer.

#### BALKERNE LANE

##### Period 1

- 2663 A116 (L17). In F39 backfill of fortress ditch. Purbeck marble veneer.

##### Period 1 or 2

- 2729 T617. Africano marble veneer.

##### Period 2

- 2726 T207. Destruction debris. Favonazetto marble veneer.  
2737 V809 F252. Ditch. Pinky-cream marble veneer.  
2744 V1279 F497. Pit. Greenstone veneer.

Period 2 or 3

2684 G392. Backfill in pipe trench(es). Purbeck marble veneer.

Periods 2 to 6?

2743 V1262. Unstratified. Purbeck marble veneer.

Period 3

2725 T111 L33. Destruction debris of Period 2. ?Cornice fragment. Stone  
unidentified.

Periods 3/4/5a

2690 J83 L16. Dump. Purbeck marble veneer.

Periods 3/4 to 6

2711 M28. Purbeck marble veneer.

2712 M28. Purbeck marble veneer.

Period 4

2706 K323 L26. Make-up. Purbeck marble veneer.

2710 K521 L119. Dump/make-up. Brecciated white and dark purple marble veneer.

2733 V563 L59. Dump. White marble veneer.

2740 V1070 F423. Post pit. Purbeck marble moulded ?cornice. Fig 198.

2741 V1114 F434+F437. Purbeck marble veneer.

2742 V1140 F441. Post pit with posthole. Veneer with moulded upper surface.  
Unidentified stone.

Period 4 or 5c/6

2698 J273. Purbeck marble veneer.

Period 5

- 2675 E230 L31. Make-up. ?Carrara marble veneer.  
2679 E475 L130. Make-up. Purbeck marble veneer.  
2682 G101 F11. Timber-lined drain. Greek green porphyry veneer.  
2683 G349. Uncertain. Period 5? Veneer. Stone unidentified.  
2685 G401 F11. Timber-lined drain. Purbeck marble veneer, brick-shaped.  
2689 H263 F68. Hearth over pit. Imperial (red) porphyry veneer.  
2697 J238 F13. Large pit. Pavonazetto marble veneer.  
2720 N314 F97. Trench/slot. Veneer of pinky-cream marble with black veins  
(fits 2716 in Periods 5/6).  
2722 N633 L59. Dump. Purbeck marble veneer.  
2723 N644 F113. Slot. Purbeck marble veneer.  
2731 V240 L46. Make-up? Purbeck marble veneer.  
2738 V813 L22. Dump. Purbeck marble veneer.  
2739 V932 L11. Dump. Veneer of white marble with some pink/orange and grey  
veins.

Periods 5/6

- 2692 J176 F32. Pit. Veneer. Stone unidentified.  
2693 J183 F41. Pit. Veneer. Stone unidentified.



- 2694 J183 F41. Pit. Veneer. Stone unidentified.
- 2695 J214 F50. Pit and midden. Purbeck marble moulded ?cornice. Fig 198.
- 2707 K415 L69. Dump. Veneer. Stone unidentified.
- 2709 K442 L60. Make-up or dump. Purbeck marble veneer.
- 2716 N65. Veneer of pinky-cream marble with black veins (fits 2720 in  
Period 5).
- 2718 N103. Purbeck marble veneer.

Period 5 to modern

- 2681 E1286 F432 contaminated. Creamy-white marble veneer.
- 2696 J218. Pit material. Purbeck marble veneer.
- 2732 V385 F28/89. Pit. Purbeck marble veneer.

Period 6

- 2674 E205 F27. Backfill of robbed pier base. Purbeck marble veneer.  
Probably reused. There is mortar on the polished surface.
- 2676 E242 F92/A. Backfill of robbed pier base. Purbeck marble veneer.
- 2680 E769 F227. Pit. Purbeck marble moulded ?cornice. Fig 198.
- 2704 K246 F15. Gully/ditch. Purbeck marble veneer.
- 2713 N19. Dull white marble veneer. Inscribed (Hassall 1977, 427-8, no 8).  
Fig 198.
- 2714 N19. Purbeck marble veneer.
- 2717 N85 L3. Topsoil. Veneer of brecciated white and dark purple marble.
- 2719 N233 F84. Pit. Veneer strip, chamfered. Stone unidentified.
- 2724 P12 F3. Robber trench. Veneer of brecciated white and dark purple  
marble.



## Period 6 or Anglo-Saxon

- 2659 A72 F16 Town ditch fill. Veneer of dull white marble with some red/orange veins.
- 2660 A72 F16. Town ditch fill. Purbeck marble veneer.
- 2662 A90 F16. Town ditch fill. Cipollino marble veneer.
- 2666 D205. Town ditch fill. Purbeck marble veneer.
- 2669 D367. Town ditch fill. Dark pink marble veneer strip.
- 2670 D372. Town ditch fill. Veneer of white, pink and orange brecciated marble.
- 2671 D388. Town ditch fill. Veneer. Stone unidentified.
- 2677 E280 L445. Town ditch fill. Dark pink marble veneer strip.
- 2678 E302 L447. Town ditch fill. Cipollino marble veneer.

## Post-Roman

- 2661 A86 L4. Topsoil and town ditch fill. Black and white brecciated marble veneer.
- 2664 D171 L2. Town ditch fill. Anglo-Saxon. Purbeck marble veneer.
- 2665 D184 L2. Town ditch fill. Anglo-Saxon. Greek green porphyry veneer.
- 2667 D243 F13/L13. Town ditch fill. Anglo-Saxon. Purbeck marble veneer.
- 2668 D290 L16. Town ditch fill. Anglo-Saxon. Purbeck marble veneer.
- 2673 E140 F24. Gravel pit. Purbeck marble veneer.
- 2686 H14 L2. Topsoil. Purbeck marble veneer.
- 2687 H104 F34? Veneer. Stone unidentified.
- 2688 H104 F34? Pink marble veneer.
- 2699 K69 L1. Overburden. Veneer strip. Stone unidentified.
- 2700 K103 F12. Robber trench. Purbeck marble veneer.
- 2701 K108 F13. Pit. Africano marble veneer.

- 2702 K208 F36. Pipe trench. Veneer? Stone unidentified.  
 2703 K240 F44. Pit. Purbeck marble veneer.  
 2705 K257 F50. Pit. Creamy-pink marble veneer.  
 2708 K436 L78 (F113). Pavonazetto marble veneer.  
 2715 N22 L1. Topsoil. White-grey marble veneer.  
 2721 N321. Surface cleaning. Purbeck marble veneer.  
 2736 V731 F185. Pit. ?Pilaster fragment. Stone unidentified. Fig 198.

#### Unstratified and uncertain

- 2672 D unstratified. Purbeck marble veneer.  
 2691 J167. Unstratified. Veneer(?) strip. Stone unidentified.  
 2727 T223 F99. Uncertain. Purbeck marble veneer. Inscribed. Fig 198.  
 2728 T223 F99. Uncertain. Purbeck marble veneer.  
 2730 V71. Unstratified. Greek green porphyry veneer.  
 2734 V727. Unstratified. Chalk brick-shaped ?veneer. Inscribed. Fig 198.  
 2735 V727. Unstratified. Purbeck marble moulded veneer.

#### MIDDLEBOROUGH

##### Period 1

- 2811 A3372 F1023. Pit. Purbeck marble veneer.

##### Period 3

- 2793 B1651 L215. Demolition debris. Pavonazetto marble veneer.  
 2800 A1812 L228. Demolition debris. Purbeck marble veneer.  
 2805 G2167 L239. Demolition debris. ?Pilaster base. Stone unidentified.

Fig 199.

2808 A2725 L263. Demolition debris. Strip. Stone unidentified.

2809 A3011 L445. Demolition debris of hypocaust. Purbeck marble veneer.

SF 792, G2830. Demolition debris. Concrete and tile column fragment. Fig 199.

Period 3 or later Roman

2779 C476 F159. Gully. Purbeck marble veneer.

2780 C476 F159. Gully. Purbeck marble ?gutter fragment. Fig 198.

Period 3 to early medieval

2795 B1691 L223. Topsoil. Purbeck marble veneer.

2796 B1691 L223. Topsoil. Purbeck marble veneer.

2nd century to early medieval

2781 C480 F160. Shallow pit. Purbeck marble veneer strip.

4th century or later

2776 B152 L4. Topsoil. Purbeck marble veneer.

2777 A160 L5. Topsoil. Greek green porphyry veneer.

Post-Roman

2774 A49 F22. Pit. Purbeck stone veneer.

2775 A145 F36. Pit. Purbeck marble veneer.

2778 A270 F64. Pit. White marble veneer strip.

- 2782 C483 L26. Site clearance, mainly topsoil. Purbeck marble veneer.
- 2783 C542 L25. Topsoil accumulation. Purbeck marble veneer.
- 2784 A739 F25. Robber trench. Purbeck marble veneer.
- 2785 A878 L598. Site clearance, mainly topsoil. Purbeck marble veneer,  
quarter circle, complete. Fig 198.
- 2786 C1018 F323. Pit. Purbeck marble veneer.
- 2787 C1141 L143. Metalling of backyard. White marble veneer.
- 2788 A1244 F43. Pit. White marble veneer.
- 2789 A1268 F399. Robber trench. Purbeck marble veneer.
- 2790 A1322 F44. Robber trench. Purbeck marble veneer.
- 2791 A1332 F38. Robber trench. Cipollino marble veneer.
- 2792 C1504 L213. Patch of charcoal. Purbeck marble veneer.
- 2794 A1668 F495. Kiln. White marble veneer.
- 2797 B1725 F508. Floor and pit. Purbeck marble veneer.
- 2798 A1753 F44. Robber trench. Carrara marble veneer.
- 2799 C1766 F490. Pit. Purbeck marble veneer.
- 2801 A1844 F554. Gully. White marble veneer.
- 2802 C1885 F349. Kiln. Purbeck marble veneer.
- 2803 C2083 L21. Site clearance, mainly topsoil. Purbeck marble veneer.
- 2804 G2160 (F416?). Robber trench. Purbeck marble veneer.
- 2806 A2476. Unstratified, but medieval or later context. Veneer. Stone  
unidentified.
- 2807 E2563 L389. Metalling of backyard. Purbeck marble veneer.
- 2810 E3066 L428. Metalling. Purbeck marble veneer.

**APPENDIX 4**

**Colchester ware louters**

by C M Cunningham

[See pages 211-4 in the book]



## Appendix 5

### The Roman tiles

by Nina Crommy

Very few complete Roman tiles were recovered from the three sites discussed in this volume. In consequence, little more than a general review of the types of tiles represented can be given here.

#### Flat rectangular tiles

Many fragments of flat tiles were found. They are in general thicker than tegulae. Such fragments could derive from either the square tiles used to make pilae or rectangular tiles such as the two illustrated here (Fig 202.1 & 2). Flat rectangular tiles could be used for a variety of purposes, such as in wall flues (Webster 1979, fig 15.2), balanced on pilae to form floors (*ibid*, fig 15.1), or in walls, notably to form string-courses (Blagg 1979, 280).

#### Flat round tiles

A few fragments of flat round tiles were found, and one complete example (Fig 202.3). Such tiles were used in columns (Wilson 1979, 11). There are no traces of mortar on the Lion Walk example.

#### Flat hexagonal tiles

These have been found on Sites R and K at Lion Walk. They derive from

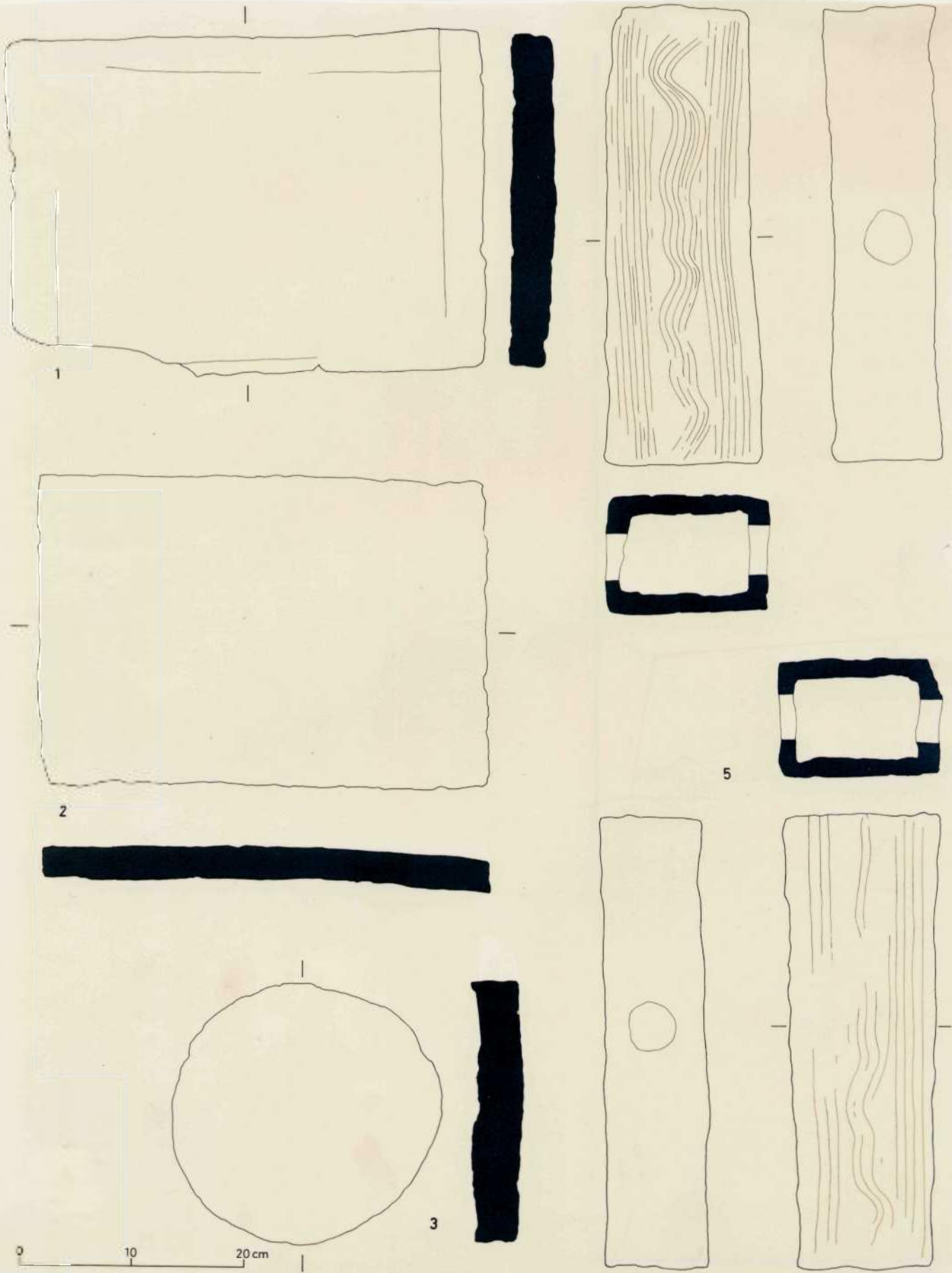


Fig 202 Roman tiles: flat rectangular and round tiles and box flue tiles

post-Roman robber trenches of Period 4 walls (KF250, RF27, RF36) and from post-Roman pits (RF31, RF34). They are almost certainly Roman. Several are illustrated here (Fig 202.4). As they vary somewhat in both plan and section, it is likely that they were cut down from larger tiles. They were probably used in a decorative floor.

#### Brick-shaped tile

One small brick-shaped tile, fired red, was found in a post-Roman context on Site K at Lion Walk. Its dimensions are 116 by 57 by 40 mm. Traces of white mortar remain on five sides, indicating that it was set on edge, almost certainly in a tile floor of herringbone pattern similar to that found in Insula 18 (Dunnett 1967, 40).

#### Hypocaust tiles

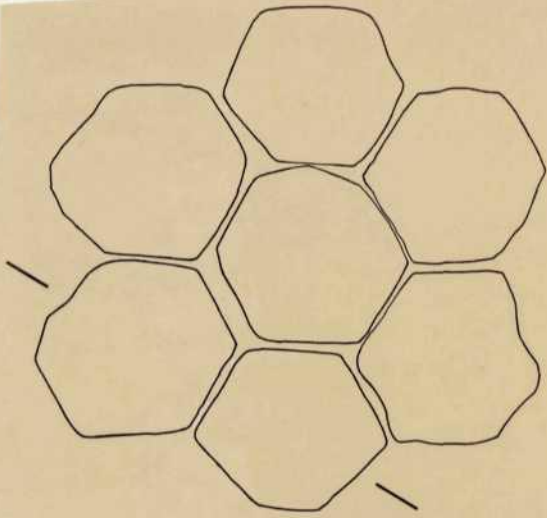
No examples of the tegula mammata were distinguished. Fragments of box tiles (tubuli) were not uncommon, with both straight and wavy comb decoration being noted. The two complete examples illustrated here (Fig 202.5) have straight comb decoration flanking wavy comb decoration.

Tile pilae were found in situ at Buildings 19 and 71. They measured approximately 200 x 200 x 40 mm (cf Rook 1977, 57). None of the tiles were retained.

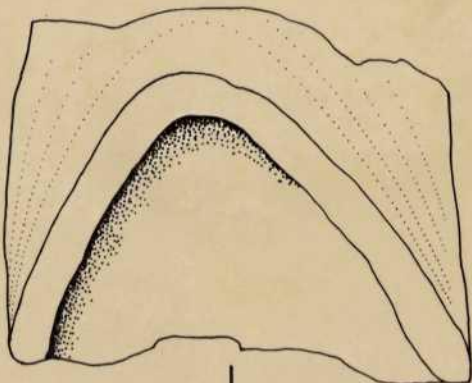
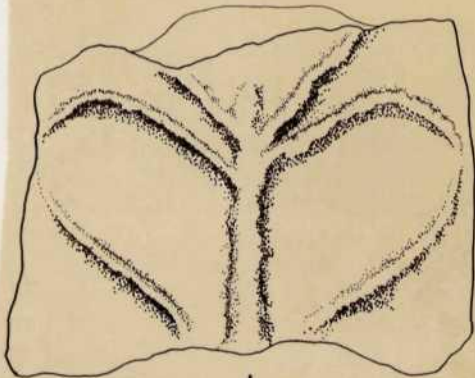
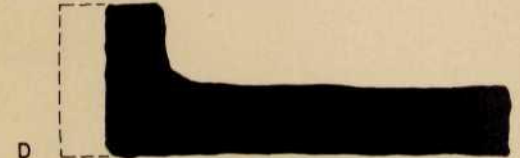
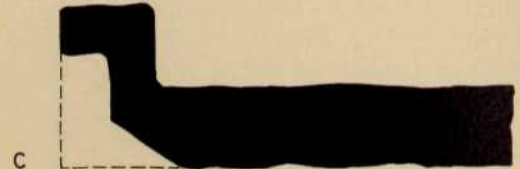
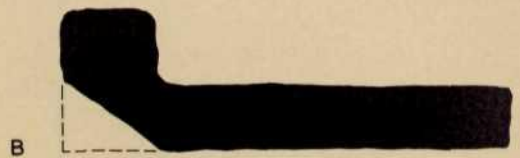
#### Antefixes

Only three fragments of antefixes were recovered; two are illustrated (Fig 203.6 & 7). The design on the front of each is similar (an ivy leaf),

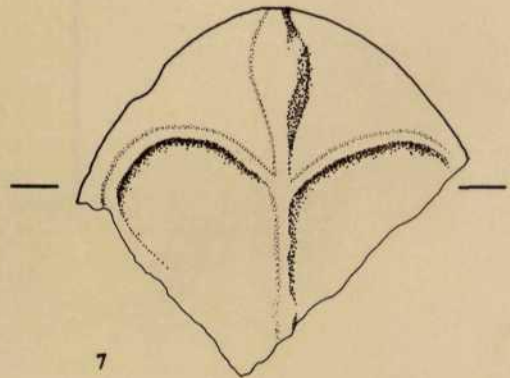




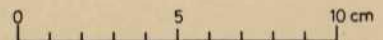
4



6



7



man tiles: antefix fragments, hexagonal tiles, and sections through lower laps of tegulae

but two have a flat back, whereas on the other there is a curved projection which probably slotted into an imbrey.

### Roof tiles

The majority of identifiable tile fragments derived from roof tiles, both flanged tegulae and curved imbrices. Most were fired red, but some (both tegulae and imbrices) were yellow (eg BKC E1329 L356, fortress ditch fill, Period 1b; BKC V1271 F350, posthole, Period 4; BKC N454 L52, floor or dump, Period 5b1), and a very few were grey. Both red and yellow tiles were noted at Braughing (Rook 1977, 57), but only imbrices, not tegulae, were yellow.

The method of manufacture of tegulae is discussed in Rook 1979. At Colchester five types of lower lap have been distinguished (Fig 203, Types A to E). Type A has only been noted in 1st and early 2nd century levels: LWC J1000 F315, timber-lined and burnt drain, Period 2; BKC J288 L35, dump and levelling deposits, Period 3/4/5a; and in the Boudican destruction levels of Building 8 on LWC J (site notes in which are listed five examples). Type B has been found in contexts throughout the Roman period: in Boudican destruction levels of Building 8 on LWC J (site notes, three examples); in Periods 4a(?) and 4b destruction debris of Building 20 at Lion Walk; and in the fill of the town ditch at Balkerne Lane. Type C (as Rook 1977, fig 22) was found in only two contexts: BKC J282 L35, dump and levelling deposits, Period 3/4/5a; and BKC H202 L12, destruction debris of Period 5b Building 59. It was absent from the Boudican destruction levels of Building 8. Type D (as Rook 1979, fig 16.3) was noted in the destruction levels of Building 8 (site notes, six examples), and a possible example (damaged) came from BKC K455 L60, make-up or dump, Period 5/6. Type E was only noted in destruction levels of



Building 8 (site notes, two examples).

As there are so few examples of each type, very little value can be placed on attempts at dating them. All have been found in immediately post-Boudican deposits, and it can therefore be assumed that all were in production by 60/1. Whether each type represents a design for a specific purpose, or is merely indicative of the style of a different manufacturer is uncertain. However, since at Braughing only one type was noted it is possible that the latter idea is correct.

Catalogue of illustrated tiles

- Fig 202.1 LWC B F70, Building 22. Probably from cellar backfill.  
Period 5. Flat rectangular tile. 305 x 425 mm (11.9 x 16.8 in).  
38 mm (1.5 in) thick.
- Fig 202.2 LWC K330 F48. Flue in Room 18 of Building 19 (Fig 45).  
Period 4b. Flat rectangular tile. 280 x 400 mm (11 x 15.8 in).  
29 mm (1.1 in) thick.
- Fig 202.3 LWC R71 F42. Pit. Period 4. Flat round tile (column brick).  
Approx 242 mm (9.5 in) diameter. 51 mm (2 in) thick.
- Fig 203.4 LWC R59 F36. Post-Roman robber trench of Period 4c foundation.  
Building 25, Rooms 7 & 8. 23 flat hexagonal tiles (seven  
illustrated). Maximum diameter 64 mm (2.5 in). 25 mm (1 in)  
thick.
- Fig 202.5 LWC R349 F119. Period 4. Building 24, Room 3. Two box flue tiles  
with combed decoration. 406 x 102 x 140 mm (1 ft 3 in x 4 in x  
5.5 in).
- Fig 203.6 BKC J188 F34. Pit. Period 5b (end?). Antefix fragment. Perhaps  
from Building 59. With ivy leaf design.

- Fig 203.7 BKC T454. Period 1. Antefix fragment. With ivy leaf design.
- Fig 203.A BKC J288 L35. Dump and levelling deposits. Period 3/4/5a.  
Tegula with lower lap of Type A.
- Fig 203.B BKC D44. Town ditch fill. Period 5/6. Tegula with lower lap  
of Type B.
- Fig 203.C BKC J282 L35. Dump and levelling deposits. Period 3/4/5a.  
Tegula with lower lap of Type C.
- Fig 203.D LWC J, Boudican destruction levels of Building 8 (site notes).  
Type D lower lap on tegulae.
- Fig 203.E LWC J, Boudican destruction levels of Building 8 (site notes).  
Type E lower lap on tegulae.

## APPENDIX 6

Tables showing the Roman painted wall plaster from Buildings 8, 67, 69, 70, and 71 (compiled by H Brooks and P Crummy)

colour	total area	percentage of total
red	27,765	65
white	4,944	12
green	1,144	3
grey	1,453	3
mustard	1,223	3
black	480	1
red & white	48	0.1
red & green	4	>0.1
red & grey	14	>0.1
red & black	5	>0.1
red & mustard	139	0.3
green & black	108	0.3
green & white	36	>0.1
mustard, grey, & red	35	>0.1
white, black, white, & green	39	>0.1
black with white line	54	0.1
red with white line	1416	3
red with darker red line	820	2
red with dark line	557	1
red with green line	88	0.2
red with darker line & white line	45	0.1
grey with white line	105	0.2
grey with dark line	20	>0.1
green with white line	50	0.1
mustard with white line	75	0.2
mustard with dark red line	72	0.2
mustard with grey line	12	>0.1
green & white with red line	4	>0.1
grey & white & darker grey line	48	0.1
grey & red & darker grey line	16	>0.1
red & mustard with white line	102	0.2
red & grey with white line	22	>0.1
red & green with black line	1264	3
red & black with white line	44	0.1
red & black with white right angle	17	>0.1
red & black with white & darker red lines	11	>0.1
black & green with white line	156	0.4
red with darker red splashes	207	0.5
red with green decoration	8	>0.1
black with white decoration	108	0.3
red with leaf & dot design	94	0.2
red with white circular design	42	>0.1
red & black with pattern	18	>0.1
red & black with pattern	36	>0.1
TOTAL	42,959	

Table 1. Painted wall plaster from Building 8, Lion Walk. Measurements in square cms.

colour	Period 1 contexts	demolished Period 1 walls	total area	percentage of total
red	279	254	533	65
white	9	140	149	18
red & white	45		45	5
black	4	35	39	5
grey		18	18	2
red & white divided by white & grey line		39	39	5
TOTAL			823	

Table 2. Painted wall plaster from Building 67, Middleborough. Measurements in square cms.

colour	<u>in situ</u>	total area	percentage of total
grey dado with yellow panels upper wall red divided into panels by green lines	48,000 (Room 4a)	48,000	75
yellow dado	5,800 (Room 5)	5,800	9
pink dado with red splashes & horizontal green band	10,500 (Passage)	10,500	16
TOTAL		65,200	

Table 3. Painted wall plaster found collapsed or in situ at Building 69, Middleborough. Measurements in square cms.

colour	Period 2 contexts	demolished Period 2 walls	total area	percentage of total
red	168	5,488	5,656	53
white	16	1,767	1,783	17
red & white	14	269	283	3
red & white with black line or pattern		855	855	8
red & white line		164	164	2
red & grey & black		17	17	0.2
red & white divided by a green line outlined white		42	42	0.4
red with green line outlined white		706	706	7
grey		82	82	1
black		24	24	0.2
green		64	64	0.6
grey & white		3	3	>0.1
white black line		8	8	0.1
white grey curve		60	60	0.6
mustard yellow		892	892	8
misc green & grey & black lines		19	19	0.2
TOTAL			10,658	

Table 4. Other painted wall plaster from Building 69, Middleborough. Measurements in square cms.

colour	<u>in situ</u>
red	3,300 (Room 7)
red	6,750 (Passage 5)
TOTAL	10,050

Table 5. Painted wall plaster in situ at Building 70, Middleborough. Measurements in square cms.



colour	Period 3 contexts	demolition of Period 3 walls	robber trenches	total area	percentage of total
red	1,040	7,649	2,837	11,526	52
white	2,352	5,766	194	8,312	37
red & white		100		100	0.6
red & white line		66	120	186	0.8
red & green line		17	345	362	2
red & grey divided by white stripe		8	2	10	>0.1
red & yellow		12		12	0.1
red & pink			78	78	0.4
red & black & white line			30	30	0.1
pink & red splashes		7		7	>0.1
yellow & red splashes		600		600	3
mustard yellow			612	612	3
yellow & white line & grey		6	4	10	>0.1
grey		99	60	165	0.7
green		54	35	89	0.4
grey/brown		16		16	0.1
white & black line	28	12	20	60	0.3
white & grey line		26		26	0.1
white & green line		22		22	0.1
TOTAL				22,223	

Table 6. Other painted wall plaster from Building 70, Middleborough. Measurements in square cms.

colour	<u>in situ</u>	demolition debris	robber trenches	later contexts	total	percentage of total
red		119		12	131	9
white	900	38	24	72	1,034	68
red & white		56		8	64	4
cream with broad & narrow red lines		85			85	6
cream with yellow line & red curve		64			64	4
mustard		80			80	5
yellow with white or grey line		47			47	3
cream with green marks				14	14	1
pink & red with black dots				4	4	0.2
TOTAL					1,523	

Table 7. Painted wall plaster from Building 71, Middleborough. Measurements in square cms.

**APPENDIX 7**

**Some technological finds from Lion Walk and Balkerne Lane**

by Justine Bayley

[See pages 214-5 in the book]

## APPENDIX 8

## Descriptions of complete or nearly complete buried pots

by R P Symonds (Roman) and C M Cunningham (post-Roman)

[Fig 205, microfiche]

## ROMAN

The form numbers cited below (prefixed by 'P') refer to the type series which will be published in a future volume of CAR devoted to the Roman pottery excavated in Colchester in the 1970s.

\* LWC BF129, 963; Fig 205, nos 1A & 1B; Building 22, Phase 2; Form no P 797a.

Bulbous jar heavy, everted rolled rim, almost without a neck, but with two grooves at the join of neck and shoulder. No decoration. Intact. Grey ware with mica visible at surface. Rim diameter 158 mm; height 209 mm. Cf CAM 268b (c. 120-2350), 'These are beyond question the commonest vessels in Roman Colchester' (Hull 1958, 285). Found upright with a large sherd of mortarium, Form no P 797b, serving as a lid. Plain mortarium with flat base, turning marks on lower body. Grey/buff fabric with buff surfaces, with clear quartz and iron ore inclusions. Sparse angular white and grey quartz grits, occasional red flints. 2nd century +.

\* LWC JF48, 100; Fig 205, no 2; in yard of Building 20, Phase 2; Form P 37.

Ovoid jar with flat base (slightly dished) and thickened everted rim rising sharply from shoulder. Light, and mostly ineffective, burnishing on rim and shoulder (on inside to smallest diameter of rim) and around base.

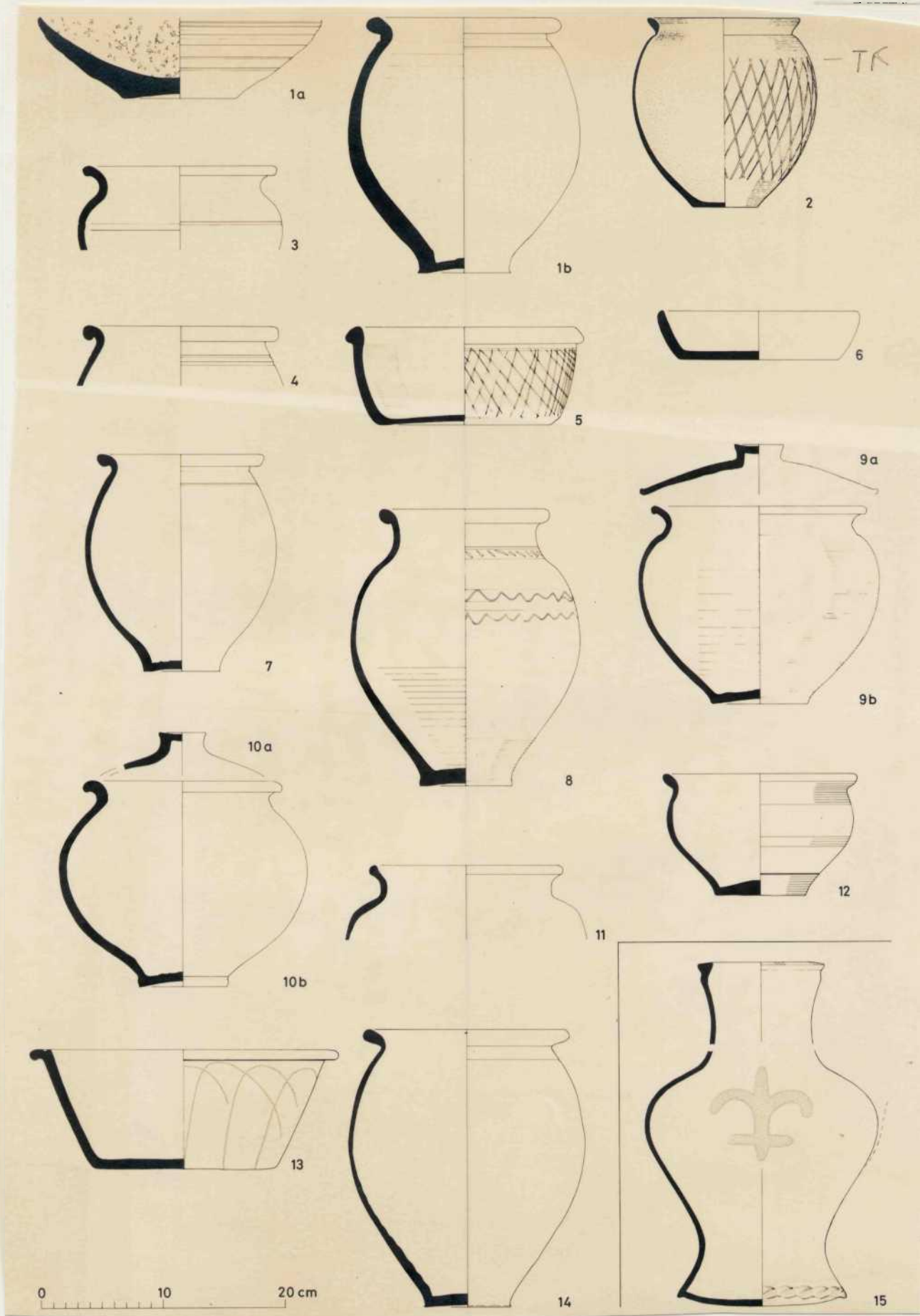


Fig 205 Pots buried or set in the ground complete or nearly complete



Acute scribed lattice on unburnished part of wall. Wire marks beneath base, turning marks on inside. Fabric BB2 (Williams 1977) with brown/grey core and dark grey surface, abundant clear and colourless quartz inclusions, with sparse black iron-ore particles, and fine mica visible at surface. Rim diameter 125 mm; height 154 mm. Parallel with Gillam 139 (AD 180-250), or CAM 278 (AD 70-350 +).

\* LWC JF73, 98; Fig 205, no 12; in yard of Building 20, Phase 2; Form P 909.

Part of small grey ware jar with restricted base, short neck and thickened, everted rim. Sandy grey ware with abundant clear and colourless quartz inclusions and sparse red iron ore particles. Rim diam. 160 mm, height 100 mm. Probably 2nd century +.

\* LWC JF74; Fig 205, no 3; in yard of Building 20, Phase 2; Form P 898.

Part of bulbous jar with slightly thickened, recurving rim. Lightly burnished above groove at shoulder, rough surface below. Medium sandy grey ware. Rim diameter 164 mm. 2nd century +.

\* LWC JF82, 158; not illustrated; in yard of Building 20, Phase 2.

A collection of sherds from a minimum of three grey ware jars. If these were originally buried whole, very little of them now survives. All are in sandy grey fabric with abundant clear and colourless quartz inclusions and occasional black iron ore particles. 1st century +.



\* LWC JF304, 908; Fig 206, no 1; Building 20, Room 2, Phase 2; Form P 899.

Base and lower body of a large storage jar, with wide flat base and slightly restricted lower body. Grey fabric with long or irregular black streaks in break; voids at surface. Parallel with CAM 273 (c 60-150 +).

\* LWC JF422, 1829; Fig 205, no 4; found in Roman layers in section; Form P 801.

Part of bulbous jar with heavy rolled rim. Two grooves at shoulder; rough surface all over. Medium sandy grey ware. Rim diameter 150 mm. 2nd century +.

\* BKC GF7, 43; Fig 205, no 5; Building 58; Form P 900.

Flat-based bowl with steep, slightly curving wall and rolled rim (triangular in section); slight basal chamfer. Burnished all over. Acute lattice on exterior wall; inside base burnished in straight lines forming triangles; this effect was therefore produced when the vessel was still, as opposed to turning on the wheel. Fabric BB2 (Williams 1977) with dark grey core and surface, moderate-to-abundant clear and colourless quartz inclusions and sparse black iron-ore particles but with no obvious mica present. Rim diameter 194 mm; height 81 mm. Mid 2nd to early 3rd century.

\* BKC GF169, 390; Building 55; not illustrated.

Base of small grey ware jar with slightly restricted base. Sandy grey fabric with abundant clear and colourless quartz inclusions and sparse red

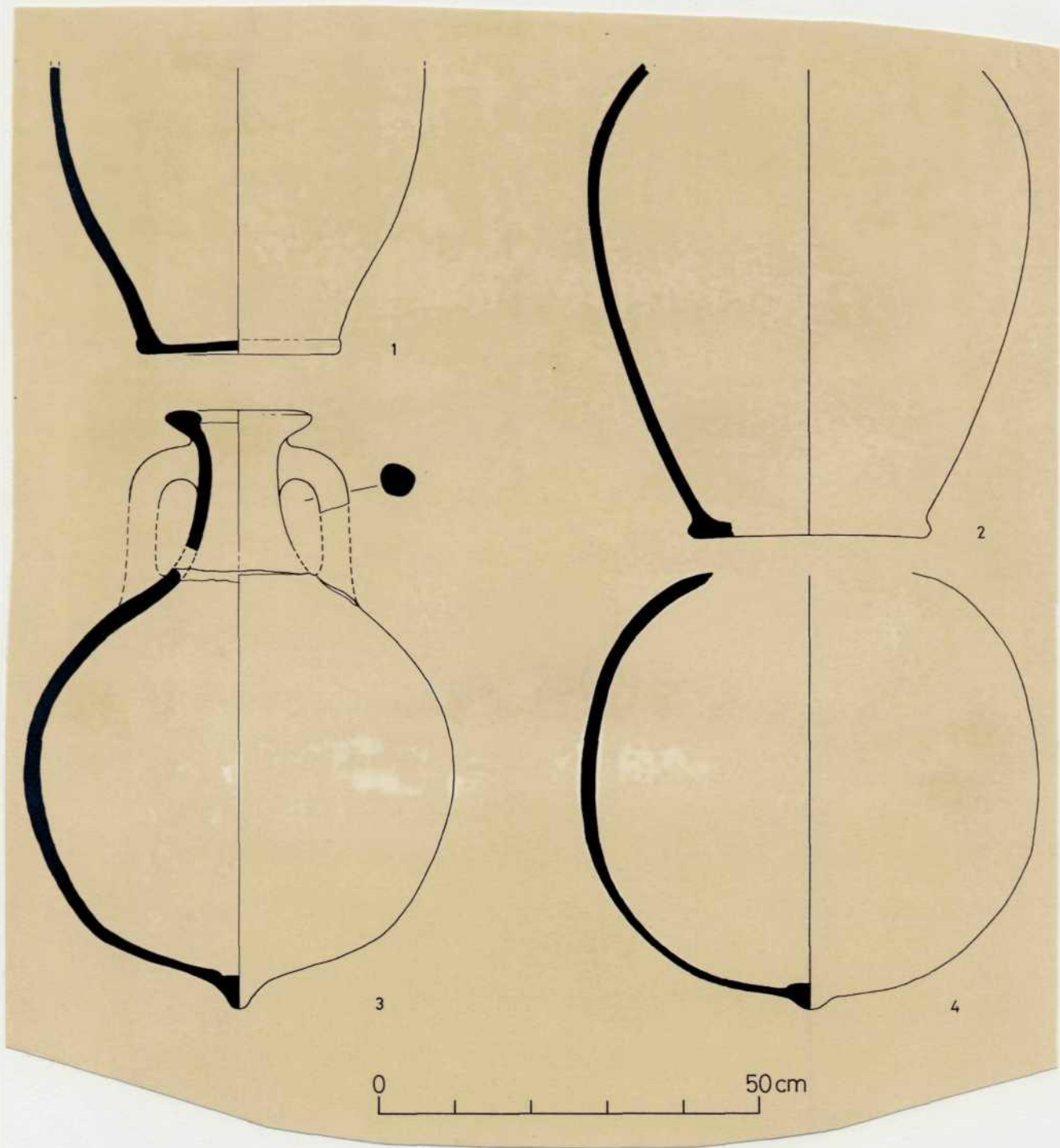


Fig 206 Pots buried or set in the ground complete or nearly complete

iron ore particles. Base diameter 50 mm. 1st century +.

\* BKC GF171, 367; Fig 205, no 6; Building 55; Form P 901.

Flat-based dish with short steep wall and plain rim. Burnished on inside wall, wiped on outside and on inside base. Intersecting arcs scribed on wall, pattern of loops on underside. Fabric BB1 (Williams 1977), with abundant clear and colourless quartz inclusions, sparse black iron ore particles, and occasional limestone and red iron ore particles. Rim diameter 164 mm; height 40 mm. 2nd to early 3rd century. Used as a lid for the pot below.

\* BKC GF171, 367; Fig 205, no 7; Building 55; Form P 902.

Bulbous jar with everted, slightly hooked rim, and very short neck, delineated by a cordon at the join of shoulder and neck. Slightly restricted base. An indentation in the middle of the wall appears to be the result of a hole having been punched in the side of the vessel before firing. Sandy grey ware with moderate-to-abundant white and colourless quartz inclusions and sparse black iron ore particles; wholly unburnished surfaces. Rim diameter approx 130 mm; height 176 mm. 2nd century +.

\* BKC GF172, 368; Fig 205, no 8; Building 55; Form P 903.

Bulbous jar with restricted base, short neck and rounded rolled rim. A pair of wavy scribed lines just above mid-body, a third wavy line just below rim; burnished rim, neck and upper body. Sandy grey ware with moderate-to-abundant white and colourless quartz inclusions and sparse black iron ore particles. Rim diameter 150 mm; height 219 mm. 2nd century +.

\* BKC JF14, 103; Fig 206, no 2; in top of pit JF13 on north side of Building 60; Form P 909.

Base and lower body of large storage jar with flat base and slightly restricted lower body. Orange/buff fabric with grey margins and surface. Moderate clear and colourless quartz inclusions with red iron ore, charcoal, and limestone flecks, and large voids. (Some of these voids appear 'fur-lined', with microscopic stalagmite-like accretions.) 2nd century +.

\* BKC JF29, 239; not illustrated; north-east of Building 60.

Body sherds of a large globular amphora, probably similar in shape to Fig 206, no 3. Buff fabric with grey core, with abundant clear and grey quartz inclusions, moderate large charcoal flecks and sparse red iron ore particles. 1st to 3rd century +.

\* BKC JF283, 254; Fig 206, no 4; pit ? under Period 6 pit JF32; Form P 908.

Part of globular amphora with small basal knob. Half the vessel missing, as if sheered away, including any evidence of handles, neck or rim. Buff fabric with grey core, with abundant clear and grey quartz inclusions and moderate red iron ore and limestone flecks. A grey accretion covers the lower part of the interior. Maximum body diameter 540 mm. Early 1st to 3rd century +.

\* BKC NF31, 107; Fig 205, no 13; in cellar of Building 65; Form P 852.

Flat-based conical bowl with steep, straight wall and slightly hooked flange. Inner rim flat and level with flange, separated by a shallow groove.



Burnished all over; intersecting arcs on wall, swirls on underside. Fabric BB1 (Williams 1977), with abundant clear and colourless quartz inclusions, sparse black iron ore particles, and occasional limestone and red iron ore particles. Rim diameter 252 mm; height 94 mm. Mid 2nd to early 3rd century. Used as a lid for the jar below.

\* BKC NF31, 108; Fig 205, no 14; in floor of cellar of Building 65; Form P 100.

Tall globular jar with restricted base and thickened, sharply everted rim. A light groove beneath the rim on the outside. Lime encrustation on the inside. Sandy grey fabric with brown core, with abundant white and colourless quartz inclusions and occasional black iron ore particles. Rim diameter 170 mm; height 229 mm. 2nd century +.

\* BKC NF116 432; Fig 206, no 3; north of Building 65, Phase 1; Form P 130.

Globular amphora with small basal knob. Rim and handles broken away and smoothed off (secondary use), but form surely as Form P 104. Brown fabric with pale grey surface, abundant clear and grey quartz inclusions with sparse limestone and white mica flecks. Rim diameter 190 mm; maximum body diameter 560 mm; height approx 800 mm. Parallel with CAM 187 (early 1st to 3rd century +).

\* BKC TF174, 420; Fig 205, 9A & 9B; Building(s) 47; Forms P 904 & 905.

Plain jar with lid. Squat globular jar with slightly restricted base, very short neck and thickened, everted rim. Rim diameter 180 mm; height 163 mm. Shallow, slightly concave lid with flattened rim, and flat-topped central knob. Rim diameter 200 mm; height 45 mm. Both in sandy grey ware with



moderate-to-abundant white and colourless quartz inclusions and sparse black iron ore particles. All surfaces smoothed but dull. 1st century +.

\* BKC TF175, 421; Fig 205, no 11; Building(s) 47; Forms P 906.

Top of wide mouthed jar with quarter-round neck and thickened, everted rim. Grey ware with sparse iron ore particles and mica, but little or no sand; harsh surface, wholly unburnished. Rim diameter 162 mm. 1st century +.

\* BKC TF176, 422; Fig 205, nos 10A & B; Building(s) 47; Forms P 841 & 907.

Plain jar with lid. Large globular jar with everted, rounded rim and short neck, thick restricted disk-base. No decoration. Rim diameter 160 mm; height 170 mm. Part of shallow, slightly concave lid, with flat-topped central knob (rim absent). Both in very hard grey fabric with moderate-to-abundant white and colourless quartz and sparse black iron ore particles; the jar having bright orange to brown surfaces, while the lid is black; all surfaces smoothed but dull. 1st century +.

\* BKC VF492, 1257; not illustrated.

Part of grey ware jar with shallow foot-ring and slightly restricted base. Sandy grey fabric with abundant clear and grey quartz inclusions and moderate mica and limestone particles. Base diameter 90 mm. 1st century +.

The following pots are missing:

LWC BF128; Building 22, Phase 2, (not located);

LWC BF130; Building 22, Phase 2 (stolen from the excavation offices);

BKC JF125; Building 44, Room 2 (stolen from the site).

## POST-ROMAN

\* MID F830; Fig 205, no 15; Building 76, Phase 1

Jug in Colchester slip-painted ware, Fabric 21A (Cunningham & Drury forthcoming). Finely thrown baluster jug with unusually bulbous body (probably imitating a metal form), thickened rim and base decorated with thumb-nail nicks. Slip painted pattern consists of the characteristic dashes on the upper rim, and three fleurs-de-lis on the upper body, that opposite the handles being covered in a bib of green glaze. The underneath of the base is also glazed. Probably late 14th or 15th century.

\* MID F242; Building 75, Phase 4.

Large storage jar, almost complete but rim broken although apparently everted. Sagging base with gently curving sides (widest towards the lower half) with two thumbed horizontal lug handles on the shoulder, and rilling between the lugs and the wide neck. A variant of Form C16 (Cunningham & Drury forthcoming). Hard orange earthenware (Fabric 40) but sandier than usual. The vessel is covered inside and out in a dark almost black glaze and is abraded internally. Circa 16th century.

The following vessels date to the 17th century (probably the second half) or the early 18th century. The two wasted vessels (F104 & F441) may represent pottery manufacture in or near Colchester at this time.

\* MID F104; Building 75, Phase 4.

Large storage jar, almost complete, with a flat base, two horizontal loop handles and a heavy collared rim (Form C16), in red earthenware, covered internally in a plain lead glaze. This vessel is a second or a waster, as it has cracked during firing along lines of weakness at the base and shoulder. This form is found at Chelmsford in the late 17th century (Cunningham & Drury, forthcoming).

\* MID F112; Building 75, Phase 4.

Base of a tripod pipkin in red earthenware and glazed internally. This vessel is worn on the inside and soot-blackened outside. Circa 17th century (Form C13).

\* MID F271; Building 75, Phase 4.

Similar base, but glazed outside and inside, and with perforations in the base, ie a press or colander (Form X12, cf ibid).

\* MID F140; Building 75, Phase 4.

Fragments from the base and lower body of a storage jar, probably Form C16A. Flat base tapering out towards a high shoulder. Fabric 40, covered internally with a clear lead glaze, much abraded externally. Similar to the two pots above.

\* MID F441; Building 75, Phase 4.

Base of an identical storage jar, which has been overfired so that the glaze has turned black.



**APPENDIX 9****Green-stained soil sample from a pit at Site J, Lion Walk**

by S Limbrey, Ancient Monuments Laboratory, Department of the Environment

A sample from one of the 'green-stained' pits in Rooms 2 and 3 of Building 20, Phase 2 (printed report p 000), was examined in an attempt to establish the cause of the discolouration.

The sample, light yellowish brown to pale olive, 2.5Y6/4-5Y6/3 moist, 5Y7/2 dry in its 'greenest' parts, was sandy clay. Otherwise it was olive yellow to very dark greyish brown, 2.5Y6/6- 10YR3/2 moist, 2.5Y6/2 dry, with ferruginous mottling and flecks of charcoal.

The phosphate content was high but not extremely so and without comparative samples from other parts of the site cannot be adequately assessed. The deposit has been waterlogged, partly or intermittently, resulting in reduction of iron, due to oxygen depletion under microbiological activity, implying a high content of organic matter. The olive colours suggest the presence of ferrous salts, a product of high anion content which could be derived from cess or urine. No test was made for tanning.

Summer 1972



## Appendix 10

### Summary of the ceramic dating evidence for some key areas at Lion Walk and Balcerne Lane by R P Symonds

The following abbreviations are used below:

#### Context type:

\* = key feature or layer

#### Quantification:

NP = no pottery

1 = 1 vessel

2 = 2 vessels

VSQ = very small quantity, 3 to 5 vessels

SQ = small quantity, 6 to 20 vessels

Q = quantity, 21 to 50 vessels

LQ = large quantity, 50 to 100 vessels

#### Dating:

CL = Claudian

NR = Neronian

PF = pre-Flavian

VP = Vespasianic

FL = Flavian

TJ = Trajanic

HA = Hadrianic

AN = Antonine

LA = late Antonine

1st = 1st century AD

2nd = 2nd " "

3rd = 3rd " "

4th = 4th " "

**Fabrics:**

AA = all amphoras (includes some datable types)

BA = Terra sigillata, with the following subdivisions where appropriate:

SG = South Gaulish

CG = Central Gaulish

EG = East Gaulish

MT = Montans (1st - early 2nd)

EL = early Lezoux (1st)

MV = Les Martres de Veyre (c 100 - 120)

CO = Colchester (mid - late 2nd)

RH = Rheinzabern (3rd)

CB = Colchester colour-coated ware (2nd - 3rd)

CE = Oxford colour-coated ware (mid 3rd - 4th), or white slipped ware with brown painted decoration (1st - 4th)

CH = Hadham ware (mid 3rd - 4th)

CL = 'Rhenish' ware (central Gaulish: c 120 until the end of 2nd, east Gaulish: c 200 - 275)

CS = 'Pompeian'-red ware (1st)

- CZ = colour-coated ware, red fabric (includes some datable types)
- DA = fine and/or decorated unslipped red ware (includes some datable types)
- DB = coarse, undecorated unslipped red ware (includes some datable types)
- EA = Nene Valley colour-coated ware (mid 3rd - 4th)
- EB = Lyon colour-coated ware (pre-Flavian)
- EC = early Colchester colour-coated ware (pre-Flavian)
- EZ = colour-coated ware, white or buff fabric (includes some datable types)
- FA = unslipped white ware, except mortaria (includes some datable types)
- FJ = Brockley Hill white ware (late 1st - early 2nd)
- FM = mortaria, general (includes some datable types)
- GA = BB1 (early 2nd - early 3rd)
- GB = BB2 (mid 2nd - early 3rd)
- GH = 'London' ware (late 1st - early 2nd)
- GY = fine or decorated grey ware (includes some datable types)
- GZ = coarse grey ware (includes some datable types)
- HD = shelly ware (4th)
- HZ = tempered ware, general (includes some datable types)
- PR = post-Roman pottery
- 
- D = 'dolium' (early 1st)
- T = tazza (2nd - 3rd)
- U = unguentarium (2nd+)
- X - indicates a vessel included in the form type series

## THE ROMAN WALL AND RAMPART AT LION WALK (SITE M)

The dating of the pottery from the rampart at Lion Walk (LWC M) was at first problematic, because of the presence of a series of sherds which must be either later intrusions or early products of industries whose floruits are usually considered to be later. These sherds constitute a very small percentage of the total (five sherds or 0.21% by weight, to be precise), but because each context is dated according to the normal date-range of what are taken to be the latest dateable elements present, a number of contexts were thought at first to be much later than the date indicated by the stratigraphy and the rest of the pottery. But a careful examination of the pottery dating evidence for each of these apparently later contexts showed that the number of sherds necessarily responsible for the late dating was very small, that all of the sherds in question were suspiciously untypical of their types, and that if all are removed the pottery within these contexts immediately becomes much more homogeneous in date.

The problematic sherds are labelled in the summary which follows by an asterix (\*). The fabrics involved are apparently Hadham ware (CH) and Nene Valley ware (EA), neither of which normally is found at Colchester before the middle of the third century. The Hadham ware sherds (Rampart 1a, Find nos 114 & 116, & Rampart 1d, Find no 109) were examined by C J Going and found to be untypical examples, possibly as early as the middle of the second century. The Nene Valley sherd (Rampart 1c, Find no 100) is an untypical bowl form: Nene Valley beakers are more abundant than the competing Colchester wares from the latter part of the third century onwards, but bowls are always rare. Among the rest of the pottery are a number of elements whose production might have continued into the third century, such as black-burnished wares (BB2)(GB), but

the examples present in the rampart do not include the forms which normally appear in later contexts, such as flanged bowls and plain-rimmed bowls. Some of the mortarium and colour-coated forms represented could also have continued in production into the third century, but no examples are necessarily late. The one other element which is quite clearly intrusive is one sherd of Medieval pottery (Rampart 1e, Find no 93), dated by C M Cunningham as 14th - 15th century.

Find no:      Quantity:      Date:      Dating evidence, by fabrics:

**Animal or spurious features in natural sand: 1st**

183	2	1st	CZ (mica gilt: 1st)
180	VSQ	Roman	
184	NP		
185	NP		

**Road 1: 1st**

174	NP		
175	NP		
173	SQ	1st	BA (SG: 1st)
182	1	Roman	
179	NP		
181	NP		

**Levelled rampart & dump of septaria for Roman town wall: probably 1st**

168	NP		
169	2	1st+	
170	VSQ	1st	BA (SG: 1st)
171	VSQ	1st	BA (SG: 1st)
172	SQ	1st - ?early 2nd	BA (SG: 65 - 80/1st), DA (1st - early 2nd)
175	NP		
177	NP		
178	NP		

**Road 2 & make-up (= construction level for Roman town wall): 1st**

162	NP		
163	NP		
164	NP		
165	NP		
166	VSQ	prob 1st	
167	1	Roman	



**Silt or dump over Road 2 and under Road 3: early 2nd+**

145	2	Roman	
146	2	Roman	
150	SQ	early 2nd - early 3rd	BA (SG: 1st), GA
151	SQ	late 1st - early 3rd	BA (SG: FL - 100), GB, GY
152	SQ	1st+	BA (SG: FL - 1st)
154	SQ	Roman	
155	SQ	late 1st - early 2nd	BA (SG: FL - 1st), GY
157	NP		
158	1	1st+	BA (SG: 1st)

**Road 3: 2nd+**

123	SQ	early 2nd - early 3rd	CZ (mica gilt: 1st), GA, GY
131	SQ	prob. 2nd+	BA (SG: FL), CZ

**Dump between Road 2 & Roman town wall & over Road 2: late 1st to early 2nd**

129	NP		
132	SQ	1st+	HZ (D: 1st)
133	SQ	Roman	
134	VSQ	late 1st - early 2nd	FJ
135	VSQ	2nd+	BA (SG: 1st) FM (2nd+)
136	NP		
137	NP		
138	SQ	2nd - 3rd	BA (SG: FL - 1st), CB, FA (disk-mouthed flagon), FM (2nd+), GY
139	SQ	late 1st - 2nd+	BA (SG: 1st), CZ (mica gilt: 1st), FJ, FM (2nd+), GY
140	NP		
141	VSQ	2nd+	DB (T: 2nd+)
142	SQ	2nd+	DB (T: 2nd+), FJ
143	Q	2nd	EA (SG: FL - 1st, MV: 100 - 120, CG: HA - AN), CZ (mica gilt: 1st), DB (T: 2nd+), FJ, GY
144	SQ	mid 2nd - early 3rd	BA (SG: FL - 100), GB, GY
147	SQ	late 1st - early 2nd+	BA (SG: 75 - 1st), GY
149	SQ	late 1st - early 2nd+	BA (SG: 1st), GY
159	SQ	1st+	BA (SG: 80 - 100)

**Dump between Road 3 & Roman town wall: late 1st - early 2nd**

125	Q	late 1st - early 2nd	BA (SG: FL - 1st, MV: 100 - 120) CZ (mica gilt: 1st), GY
-----	---	----------------------	---

**Ditch (F60) for Road 3: mid 2nd+**

126	Q	early 2nd+	BA (SG, MT: FL - TJ, EG: HA), CZ (mica gilt: 1st), FJ, FM (2nd+), GA (X), GY
120	SQ	mid 2nd - 3rd	BA (SG: FL - TJ, MV: 100 - 120, CG: HA - AN), CB, ?CE, CZ (mica gilt: 1st), GB
156	VSQ	1st+	EA (SG: 1st)

**Silt & dump over Road 3: 2nd+**

127	SQ	late 1st+	<b>GY</b>
-----	----	-----------	-----------

128	NP		
130	SQ	2nd+	BA (SG: FL - 1st, MV: 100 - 120, CG: HA - AN), FM (2nd+), GY
<b>Rampart 1a: mid 2nd+</b>			
111	Q	2nd+	BA (SG: FL - 1st, MV: 100 - 120, CG: HA - AN) CE (not Oxford ware), FJ, FM, GB
113	SQ	mid 2nd - early 3rd	BA (SG: FL - 1st, MV: 100 - 120, CG: HA, EG: HA - AN), FM (2nd+), GB
114	Q	mid 2nd+	BA (SG: FL, MT: early 2nd, CG, EG: HA - AN) CH*, CZ, FA (X) (U: 2nd+), FJ, FM (2nd+), GA (X), GB
115	Q	2nd - 3rd	BA (SG: FL - 1st, MV: 100 - 120, CG, EG: HA - AN, RH: AN), ?CE (not Oxford ware), CZ (mica gilt: 1st), DB (cheese-press: 2nd+), FA (T: 2nd+), FJ, GA, GB, ?HD
116	SQ	2nd+	BA (CG: HA), ?CH*
117	NP		
118	SQ	late 1st - early 2nd	EB, GY
119	SQ	prob 2nd+	BA (SG: 1st), ?CE (not Oxford ware)
120	SQ	mid 2nd - 3rd+	BA (SG: FL - TJ, MV: 100 - 120, CG: HA - AN), CB, ?CE (not Oxford ware), CZ (mica gilt: 1st), GB
121	SQ	mid 2nd - early 3rd	BA (SG: FL - TJ, CG: ?HA), GA, GB
124	NP		
<b>Rampart 1b: mid 2nd+</b>			
102	Q	mid 2nd - 3rd	BA (SG: 1st, CG: 2nd), CL, EZ, GA, GB
110	SQ	mid 2nd - early 3rd	BA (SG: FL - 1st, CG: HA - AN), GB
<b>Rampart 1c: mid 2nd+</b>			
100	Q	2/2 2nd+	BA (SG: 1st, CG: HA - AN), CB, EA*, EZ, GB
<b>Rampart 1d: mid 2nd+</b>			
103	SQ	mid 2nd - early 3rd	BA (SG: 1st, CG/EG: 2nd), GB
105	SQ	late 1st - mid 2nd	BA (SG: 1st), CZ (mica gilt: 1st), FJ, GY
106	NP		
107	VSO	Roman	
108	SQ	mid 2nd - early 3rd	BA (SG: FL?), GB
109	SQ	late 2nd - 3rd	BA (SG: 1st, CG: HA - AN), CH*, GA, GB, GY
112	SQ	130+	BA (SG: 1st, EG: HA), CE (not Oxford ware), EZ, GA, GB, GY (X)
<b>Road 4: mid 2nd+</b>			
99	SQ	early - mid 2nd+	BA (CG: HA - AN), CB, GA
101	VSO	2nd+	BA (CG: AN)
104	VSO	Roman	
105	SQ	late 1st - mid 2nd	BA (SG: 1st), CZ (mica gilt: 1st), FJ, GY

**Rampart 1e: mid 2nd+**

76	Q	2nd - early 3rd	BA (MV: 100 - 120), CG: HA - AN), CB, CZ, DB (T: 2nd+), GA, GB
77	Q	2nd+	BA (SG: FL - TJ, CG: 2nd), EZ, FM (X: 2nd+), GB (X), GH
78	Q	2nd - early 3rd	BA (SG: FL, CG: HA - AN, EG: AN), CB, FM (2nd+), GA
84	1	Roman	
85	Q	2nd - early 3rd	BA (CG: AN, EG: AN), CB, CZ, DB (T: 2nd+), EZ, FM (2nd+), GB
86	Q	2nd - early 3rd	BA (SG: 1st, CG: HA - AN), CB, FM (2nd+), GA, GB
92	SQ	2nd+	BA (SG: FL - 100, CG: HA - AN), CS, DA, EZ, GB
93	SQ	2nd - early 3rd, PR*	BA (SG: FL - 100), CB, FM (2nd+) PR = 1, 14th - 15th*
95	Q	mid 2nd - early 3rd	BA (SG: 1st, CG, EG: HA - AN), CZ, GB
96	SQ	mid 2nd - early 3rd	BA (SG: FL), GB
97	SQ	mid 2nd - early 3rd	BA (CG: 2nd), GB
98	SQ	mid 2nd - early 3rd	BA (SG: 1st, CG: HA - AN), CZ (X), GA, GB
99	SQ	early - mid 2nd+	BA (CG: HA - AN), CB, GA

**Rampart 2: 3rd to 4th**

61	VSQ	Roman	
62	VSQ	2nd - 3rd+	CZ, EZ, HD
71	VSQ	Roman	
87	2	mid 2nd - early 3rd	<b>GB</b>
88	NP		
89	1	2nd+	<b>GY</b>
90	SQ	2nd - 3rd	CL, CZ, GB
91	SQ	early - mid 3rd	BA (CG: TJ - HA), CE, FJ, GB (flanged bowl)
94	SQ	3rd - 4th	BA (CG: AN), FM (3rd - 4th), GB
187	SQ	2nd - 3rd	BA (SG: 1st), CZ
188	SQ	3rd+	CZ, GA, GB
189	SQ	3rd - 4th	BA (SG: 1st, CG/EG: 2nd), CH, CZ, DA (3rd), FM (Nene Valley, 250 - 350), GA, GB

**SUMMARY OF THE CERAMIC DATING EVIDENCE FOR BKC SITE K**

Although the pottery dating evidence for Periods 1 & 2 is relatively thin, with only a handful of closely datable sherds, the group as a whole is probably pre-Boudican. The pottery in Period 3 appears to be Flavian, containing mostly residual pre-Boudican wares, but also including white wares from Brockley Hill which are unlikely to have reached Colchester before about AD 65-70. Period 4a also contains Brockley Hill wares, as well as what



appears to be a very early example of BB1 (Williams 1977), which might have reached Colchester just at the end of the 1st century. Period 4b contains too little pottery to be certain, but it appears contemporary with 4a, while 4c may also be contemporary, but with the increasing incidence of BB1, albeit early examples, 4c might be as late as c 120. The single sherd of Nene Valley ware in Period 4b/c, L111, find no 508 is almost certainly intrusive. Periods 5/6 & 6 appear to be Antonine and late Antonine, respectively, the latter being possibly as late as mid 4th century, as it includes some Oxford ware and shelly ware, but the five incidences of modern pottery must be the result of contamination.

#### Period 1

F120 no finds

F126*	544	SQ	?early 1st	DB, GY
	561	VSQ	1st	GY
	562	NP		
	563	NP		
	613	NP		
	628	2	Roman	-

#### Period 1/2

F20	127	VSQ	Roman	-
F111	400	VSQ	1st+	BA (SG: 1st)
	401	SQ	Roman	-
	414	SQ	1st+	CS
F133	no finds			
F134	no finds			
F126*	477	SQ	1st	GY
	478	SQ	Roman	-
	527	SQ	1st	BA (SG: 1st), GY
	529	NP		
	531	SQ	1st	BA (SG: 1st)
	532	NP		
	575	NP		
F126*	543	SQ	1st	BA (SG: 1st)
L66	399	SQ	1st+	CZ
L120*	684	NP		

L122*	537	SQ	1st	BA (SG: 1st)
L123*	546	SQ	1st	BA (SG: 1st), CS
L124*	547	SQ	?1st	-
L129	no finds			
L130*	553	VSQ	Roman	-
L131*	549	SQ	Roman	-
L132*	550	2	Roman	-
L133*	582	1	Roman	-
L136*	565	NP		
	566	VSQ	Roman	-
	658	NP		
	674	SQ	prob pre-Flavian	BA (SG: PF, ?FL), CZ, GY
	682	NP		
	683	NP		

## Period 2

F119	586	VSQ	Roman	-
L77*	433	NP		
	444	NP		
	462	NP		
	463	NP		
	464	NP		
	465	NP		
	534	1	Roman	-
L125*	535	NP		
	541	VSQ	pre-Flavian	BA (SG: CL - NR)
	551	SQ	?pre-Flavian	BA (SG: PF - 1st), GY
L127*	540	VSQ	Roman	-

## Period 3

F121*	631	Q	Flavian - Trajanic	FJ, GY
	632	NP		
	634	SQ	Roman	-
	651	Q	Flavian - Trajanic	FJ, GY
	652	NP		
	653	NP		
	654	NP		
	655	SQ	Flavian	GY
	676	NP		
	677	NP		
	678	Q	Flavian - Trajanic	GY
	681	NP		



F125*	530	VSQ	prob late 1st - early 2nd	GY
	548	SQ	Flavian	BA (SG: FL), CS
	592	NP		
	593	Q	prob pre-Flavian	BA (SG: PF - ?FL), EC, FA (Hofheim), GY
	600	NP		
	612	SQ	Flavian	BA (SG: PF - 1st), FM, GY
	615	SQ	1st	BA (SG: PF - 1st), DB, GY
L31*	476	SQ	prob 1st	GZ
	356	1	pre-Flavian	BA (SG: PF)
	359	1	pre-Flavian	BA (SG: PF)

#### Period 4a

F45	362	1	Roman	-
F103	560	VSQ	prob 1st	GZ
F125*	384	SQ	Flavian - early 2nd	BA (SG: FL), FJ
	385	SQ	Flavian	GY
	386	Q	Flavian	BA (SG: FL, MT: 1st), GY
	408	SQ	Flavian	BA (SG: PF - 1st), GY
	409	NP		
	374	SQ	?Boudican	BA (SG: 1st - inc. burnt sherds)
	423	SQ	Flavian - early 2nd	BA (SG: FL - 1st), FJ
	424	NP		
	425	Q	Flavian - early 2nd	BA (SG: PF - FL), CS, EC, FJ, GY
	426	NP		
	450	SQ	Flavian	BA (SG: PF - 1st), CS, DA
	457	SQ	Flavian	BA (SG: PF - 1st), CS, GY
	410	SQ	1st	BA (SG: PF - 1st), GY
	427	SQ	1st+	BA (SG: PF - 1st)
	449	SQ	Flavian - Trajanic	BA (SG: PF - 1st), GY
	458	VSQ	1st	BA (SG: 1st)
	459	SQ	pre-Flavian	BA (SG: PF - 1st), EC
Sinkage into top of F121	569	NP		
	570	SQ	prob 2nd	CZ
	588	SQ	Flavian - Trajanic	BA (SG: PF - 1st), GY
	590	NP		
	610	SQ	Flavian - Trajanic	GA (?early), GY
	616	NP		
	617	SQ	pre-Flavian	BA (SG: PF)
	618	NP		
	629	NP		
	630	SQ	Flavian - Trajanic	BA (SG: VP - 1st), GY

#### Period 4b

F84	no finds			
L28*	346	SQ	pre-Flavian	BA (SG: PF - 1st), GY
	348	SQ	?pre-Flavian	CZ
L97*	494	NP		

	501	SQ	prob 1st	-
<b>Period 4c</b>				
F132	665	2	Roman	-
L5	224	VSO	Roman	-
	280	VSO	Flavian	BA (SG: FL)
	305	SQ	1st	BA (SG: 1st)
L6	203	VSO	1st	BA (SG: PF)
	279	1	?pre-Flavian	CZ (mica gilt)
	352	SQ	prob 1st	DB, GY
L26*	322	SQ	late 1st - early 2nd	BA (SG: PF - 1st, ?MV: FL - TJ), GY
	323	SQ	1st	BA (SG: FL), GY
	324	VSO	1st	CS
	308	VSO	Roman	-
L42	432	NP		
	471	VSO	?pre-Flavian	BA (SG: PF)
L43	380	SQ	1st	FM
	533	SQ	Flavian - Trajanic	BA (MV: FL - TJ), FA
	538	VSO	Roman	-
	586	VSO	Roman	-
L96	383	SQ	Flavian - Trajanic	BA (SG: 1st), GY
L47	393	VSO	Roman	-
L61*	394	NP		
	395	SQ	Flavian	BA (SG: FL), DB, FA
	396	NP		
	456	VSO	Roman	-
	460	SQ	?1st	GY
	461	SQ	late 1st - early 2nd	GY
	467	SQ	Flavian - Hadrianic	BA (SG: PF - FL), CZ, FM, GY
505	1	Roman	-	
L68	405	1	1st	BA (SG: 1st)
	469	VSO	Roman	-
L82	472	SQ	Flavian	BA (SG: FL), EC, GY
	509	SQ	pre-Flavian	BA (SG: PF - 1st)
	672	SQ	Flavian - Trajanic	BA (SG: PF - 1st), GY
L83	473	2	1st	BA (SG: 1st)
L84	474	VSO	Roman	-
	480	NP		
L86	475	VSO	Roman	-
L89	481	1	Roman	-
	492	SQ	1st+	BA (SG: 1st), GY

L90	479	VSQ	Roman	-
L91	482	SQ	Roman	-
	483	SQ	Roman	-
	484	SQ	Roman	-
	485	SQ	?1st	DB
	490	SQ	?1st	-
	498	SQ	Roman	-
	636	1	Roman	-
L92	489	VSQ	early 2nd - early 3rd	GA (BB1)
L94	488	VSQ	Roman	-
L95	486	SQ	pre-Flavian	BA (SG: PF)
	493	SQ	?pre-Flavian	BA (SG: PF - 1st), EC
L96	491	SQ	Flavian - Trajanic	BA (SG: FL), GY
L98	495	SQ	Flavian - Trajanic	FM, GY
	502	2	Roman	-
L99	496	SQ	Flavian+	BA (SG: PF - 1st)
	503	VSQ	Flavian+	BA (SG: FL - 1st)
	514	VSQ	Roman	-
L100	497	VSQ	1st+	BA (SG: prob. 1st)
	515	2	Roman	-
L102	517	2	Roman	-
L105	499	SQ	Flavian - Trajanic	BA (SG: 1st), GY
L106	500	SQ	Flavian	BA (SG: FL - 1st)
L114	512	NP		
L115	513	NP		
L116	516	SQ	prob 1st	GZ
L117	518	SQ	Flavian - Trajanic	GY
L140	583	1	Roman	-
	608	VSQ	Flavian +	GY
	609	NP		
	633	SQ	2nd+	FM
L142	587	NP		
	594	1	1st	BA (SG: 1st)
	605	NP		
	606	VSQ	Roman	-
	622	VSQ	Roman	-
	623	1	Roman	-
L144	595	SQ	Roman	-
	607	SQ	1st	BA (SG: 1st), GY

L146	620	NP			
	621	SQ	1st		BA (SG: PF - 1st)
	644	VSQ	pre-Flavian +		EB
L149	637	SQ	early 2nd+		GA (prob. early BB1)
L150	638	SQ	Flavian - Trajanic		GY
L152	643	VSQ	1st		BA (SG: 1st), FA (Hofheim)
L153	659	SQ	1st	373	SQ pre-Flavian
L154	660	SQ	Flavian		BA (MV: FL)
L155	667	SQ	Roman		-
L156	668	SQ	Flavian - Trajanic		BA (SG: 1st), DB, GY
L158	661	SQ	Flavian		BA (SG: PF - FL), EC
L159	666	SQ	?pre-Flavian		EC

## Period 4 a/b

F122	571	SQ	Flavian - Trajanic		BA (SG: PF - 1st), FA (T), GY
	579	SQ	Flavian+		BA (SG: FL - 1st)
	599	SQ	1st		BA (SG: 1st)
L32*	360	2	Flavian		BA (SG: PF - FL)
	355	VSQ	Flavian		BA (SG: PF - 1st)
L35*	361	SQ	Flavian		BA (SG: Flavian)
	363	SQ	Roman		-
	372	VSQ	1st+		EA (SG: 1st)
L39*	369	VSQ	1st - 2nd		CZ
	373	SQ	pre-Flavian		BA (SG: PF - 1st), EB
L50	392	VSQ	pre-Flavian		EC
	468	SQ	?pre-Flavian		BA (SG: 1st), EC
	504	SQ	pre-Flavian		BA (SG: PF), EC
	554	SQ	Flavian		BA (SG: ?PF), GY
L137	572	SQ	1st - 2nd		BA (SG: PF), FM
	568	NP			

## Period 4 b/c

L111	508	SQ	Flavian - Trajanic/ 3rd - 4th (1)		BA (SG: PF - 1st), GY/ EA (1)
L112	510	NP			



## Period 4 a/b/c (ie Period 4)

L45	382	1	Flavian	BA (SG: FL - 1st)
L134	555	NP		
	556	SQ	Flavian+	BA (SG: FL - 1st)
	558	NP		

## Period 4d

No finds

## Period 5

No finds.

## Period 5/6

<b>F3</b>	<b>14</b> <b>76</b>	<b>2</b> <b>NP</b>	Roman	-
F24	149 187	VSO 2	Roman early 2nd - early 3rd	- GA (BB1)
F57	259 268 288	SQ SQ NP	mid 2nd - early 3rd mid 2nd - 3rd, PR	GA (BB2) CZ, GA (BB1 & 2), PR (modern)
F65	317	1	2nd - 3rd	CZ
F76	315	SQ	Roman	-
F80	333 369 378	VSO VSO SQ	3rd - 4th 2nd - 3rd mid 2nd - 3rd	EA CZ BA (SG: 1st), CL, GA (BB2)
F81	334	VSO	mid 2nd - 3rd+	CZ, GA (BB2)
F83	338	NP		
F86	349	NP		
F108	371	1	Roman	-
F124	584 585 598	SQ NP NP	3rd - 4th	CE
F128	657 670	2 SQ	1st 3rd+, PR	BA (SG: 1st) CZ, PR (modern)
F131	669	NP		
<b>L8</b>	137 125 236	1 VSO VSO	2nd+ mid 2nd - early 3rd 2nd - 3rd	FM GA (BB2) CL (CG), CZ



L9	304	SQ	2nd+	CZ
	353	2	Roman	-
L20*	327	VSQ	2nd+	BA (?; prob 2nd)
	335	SQ	Antonine	BA (CG: AN)
	320	VSQ	prob 1st	DB (lid)
L34*	357	SQ	mid 2nd - 3rd	BA (CG: late 2nd - 3rd), CZ, GA
	365	VSQ	3rd+	CZ
L38*	420	NP		
	421	SQ	2nd - 3rd	CZ
	431	NP		
	445	SQ	mid 2nd+	CZ (folded beaker), GA
	526	NP		
	418	1	Roman	-
	419	NP		
L49	404	NP		
	389	NP		
	390	NP		
	422	NP		
	446	NP		
	447	NP		
	452	NP		
	453	NP		
	454	SQ	2nd - 3rd	CZ
L59*	388	NP		
	402	SQ	3rd - 4th	CH
	403	SQ	prob 3rd - 4th	BA (CG: late 2nd - 3rd), CE, GB (flanged bowl)
	417	NP		
L60*	391	VSQ	Flavian	BA (SG: FL)
	437	2	Roman	-
	438	SQ	2nd - 3rd	BA (CG: 2nd), CZ, DB
	439	SQ	2nd - 3rd	CZ, GA (BB1)
	440	1	Roman	-
	441	2?	late 2nd - early 3rd	CL
	442	NP		
	443	NP		
	455	SQ	mid 2nd - early 3rd	GA
	470	NP		
487	VSQ	2nd - 3rd	CZ	
L61*	394	NP		
	395	SQ	Flavian	BA (SG: FL), DB, FA
	396	NP		
	456	VSQ	Roman	-
	460	SQ	?1st	GY
	461	SQ	late 1st - early 2nd	GY
	467	SQ	Flavian - Hadrianic	BA (SG: PF - FL), CZ, FM, GY
	505	1	Roman	-
L62	397	1	2nd	BA (EG: 2nd)

L64	398	VSQ	1st+	GY
L69	406	VSQ	late 1st+	BA (MV; FL - TJ)
	407	VSQ	Roman	-
	415	SQ	1st+	BA (SG: 1st)
	416	SQ	2nd - 3rd, PR	CZ, PR (modern)
	434	1	Roman	-
L72	413	NP		
	430	VSQ	Roman	-
<b>Period 6</b>				
F6*	16	SQ	3rd - 4th	EA, GY (folded beaker)
	34	NP		
	37	SQ	?3rd - 4th	HD
	121	SQ	3rd - 4th	EA, GA (BB2)
	130	SQ	late 3rd - 4th	EA, HD
	142	NP		
	160	SQ	3rd - 4th	CE, EA, GA (flanged bowl)
	163	2	?pre-Flavian	GY
	164	SQ	?3rd - 4th	?CE
	165	SQ	pre-Flavian	BA (SG: PF), EC, GY
	170	SQ	mid 2nd - early 3rd	GA (BB2)
	173	VSQ	early 2nd - 3rd	CB, GA (BB1 - flanged bowl)
	179	SQ	late 3rd - 4th	CH
	273	SQ	200 - 250	CB, CZ, GA (BB2 - flanged bowl)
	281	SQ	2nd - 3rd	CB
	299	SQ	3rd - 4th	CH, EA
	282	NP		
	174	SQ	1st	BA (SG: 1st), GY
F12*	49	NP		
	61	SQ	late Antonine, PR	CZ (mica gilt), GA (flanged bowl), PR (modern)
	71	SQ	3rd - 4th	CZ, FM (CE), GA (flanged bowl)
	78	SQ	mid 3rd - 4th	EA
	88	SQ	3rd - 4th	EA, FM (import)
	93	SQ	late 3rd - 4th	BA (EG: LA), FM (Nene Valley), GA (flanged bowl)
	103	SQ	mid - late 2nd	GA (BB2)
	110	SQ	3rd - 4th	CH, CZ
	128	VSQ	Roman	-
	147	SQ	3rd - 4th	CZ, EA
	154	SQ	3rd+	GA (flanged bowl), GY (folded beaker)
	168	SQ	4th	CE, CH, HD
	186	SQ	2nd+	BA (CG: 2nd)
	190	SQ	3rd - 4th	CZ, EA, GA (flanged bowl)
	198	SQ	Antonine	BA (CO: late 2nd)
	204	SQ	3rd - 4th	BA (SG: PF), CZ, GA (flanged bowl)
	223	SQ	2nd - 3rd	CZ
	230	SQ	200 - 250	GA (BB2 - flanged bowl)
	249	VSQ	Roman	-
	116	VSQ	200 - 250	GA (flanged bowl)
F15*	77	Q	mid 2nd+	BA (SG: PF, CG: mid 2nd+),

				EC, GH, GY
	82	SQ	Roman	-
	83	1	late 1st+	
	84	NP		
	85	NP		
	87	SQ	2nd+	GY
	94	SQ	?pre-Flavian	BA (SG: PF)
	95	NP		
	112	SQ	3rd - 4th	EA
	113	SQ	3rd - 4th	CH
	119	VSQ	65 - 80	BA (SG: FL)
	120	SQ	Trajanic	BA (SG: 1st, MV: TJ), GY
	129	SQ	mid - late 2nd	BA (SG: FL - 1st), FM (1st), GA
	139	SQ	Flavian - Trajanic	FM, GY
	140	SQ	3rd - 4th	EA
	141	SQ	early 2nd - ?4th	CH?, CZ
	143	SQ	early 2nd - early 3rd	GA (BB1)
	144	VSQ	Roman	-
	156	SQ	3rd - 4th, PR	CH, PR (modern)
	157	SQ	late Antonine	BA (EG: LA)
	161	SQ	Roman	-
	169	VSQ	Roman	-
	180	1	3rd - 4th	CZ
	196	2	Roman	-
	211	NP		
	212	SQ	?4th	HD?
	225	SQ	3rd - 4th	EA
	226	VSQ	1st	BA (SG: FL)
	234	SQ	mid 2nd - 3rd+	CB, CE, GA (BB1 & 2)
	246	SQ	late 1st - mid 2nd	EZ, GY
	247	NP		
	260	VSQ	Roman	-
	263	SQ	?3rd - 4th	DA
	275	VSQ	prob late Roman	GZ
	292	1	2nd+	FM
	297	VSQ	3rd+	CZ
F26	155	SQ	2nd - ?4th	CZ, HD
	172	SQ	3rd - 4th	CH, EZ, FM, GA (BB2)
F28*	175	SQ	early 2nd - early 3rd	GA (BB1 & BB2)
	182	SQ	3rd - 4th	CE, CH, EA
	193	SQ	3rd - 4th	CE, CH, CZ
	200	SQ	mid 2nd - early 3rd	GA
	206	SQ	mid 2nd - early 3rd	GA
	261	SQ	late 1st - early 2nd	GY
	300	NP		
	347	SQ	Roman	-
	354	NP		
F31	185	SQ	3rd - ?4th	CH, CZ, HD
F39	218	VSQ	mid 2nd - early 3rd	GA (BB2)
	272	VSQ	Roman	-
	290	VSQ	Roman	-
	291	VSQ	prob 3rd	EZ
F72	306	SQ	3rd - 4th	CE (Oxford), CZ



L18*	328	SQ	3rd+	BA (CG: LA), CZ
	340	SQ	mid 2nd - 3rd	BA (CG: late 2nd - 3rd), CZ, GA
	393	VSQ	Roman	-
	350	SQ	200 - 250	GA (BB2 - flanged bowl)

**Period 4c/5/6**

L13	319	VSQ	1st+	BA (SG: 1st)
	325	SQ	Flavian +	EC, GY
L24	308	VSQ	Roman	-
L25	339	VSQ	1st+	FM
	351	SQ	early 2nd - early 3rd	GA (BB1)
	344	2	Roman	-
L109	506	VSQ	1st+	FM
L118	647	SQ	Flavian - Trajanic	BA (SG: PF - FL, EL: PF), GA (BB1?), GY, HD
	648	NP		
	671	SQ	Flavian	BA (SG: 1st), DA, GY
L146	620	NP		
	621	SQ	1st	BA (SG: PF - 1st)
	644	VSQ	pre-Flavian +	EB
L110	507	2	Roman	-

**Period 4c/5 - probably Period 5**

L48	601	VSQ	2nd - 3rd	<b>CZ</b>
L58	574	SQ	2nd - 3rd	GY, GZ
	596	NP		
	611	1	Roman	-
	625	VSQ	mid 2nd - early 3rd	GA (BB2)
	567	NP		

**A SUMMARY OF THE POTTERY DATING EVIDENCE FOR THE CULTIVATED  
AND OVERLYING SOIL FROM BKC SITE V**

From the nature of the pottery, as well as the nature of the contexts involved, it seems reasonable to consider the pottery from all of the following contexts as belonging to one single large group. The group as a whole falls within the range early 3rd to early 4th centuries, but given the

basis on which this dating has been arrived at, there is no reason why all of the pottery could not fall within the more restricted range suggested by the coins. The earlier date within the range is suggested by the presence of BB2 flanged bowls, which do not generally occur before the early 3rd, but all of which could, in this case, be as late as the 3rd quarter of the 3rd; and the later date is fixed by the presence of Hadham wares and Nene Valley wares, both of which begin to be found in quantity from the 3rd quarter of the 3rd, and the absence of Oxford wares, shelly wares, and Mayen ware, all of which do not tend to be found in quantity at Colchester before the 2nd quarter of the 4th. The two sherds of post-medieval pottery are almost certainly intrusive.

### Layer 5

Find no:	Quantity:	Date:	Dating evidence, by fabrics:
5	SQ	mid 2nd - 3rd	CZ, GA (BB2)
6	SQ	mid 2nd - 3rd	CZ, GA (BB2)
11	SQ	mid 2nd - early 3rd	GA (BB2)
13	SQ	mid 2nd - 3rd+	CB, CH, CZ, EA, GA (BB2)
14	SQ	mid 2nd - 3rd	CZ, GA (BB2)
15	SQ	mid 2nd - early 3rd	GA (BB2)
16	SQ	mid 2nd - early 3rd	GA (BB2)
20	SQ	3rd - 4th	EA
26	SQ	mid 2nd - 3rd	CB, GA (BB2)
27	SQ	Roman	
28	SQ	mid 2nd - early 3rd	GA (BB2)
29	SQ	mid 2nd - early 3rd	GA (BB2)
34	SQ	mid 2nd - early 3rd	GA (BB2)
35	SQ	Hadrianic - Antonine	BA (CG; HA - AN)
41	SQ	early 2nd - early 3rd	GA (BB1)
43	SQ	Roman	
45	SQ	late 2nd - early 3rd	GA (BB2)
46	SQ	mid 2nd - early 3rd, PR	GA (BB2) PR = 1, post-medieval
47	SQ	mid 2nd - early 3rd	GA (BB2)
49	SQ	3rd - 4th	EA
54	Q	mid 2nd - early 3rd	FA, GA (BB2)
67	Q	mid 2nd - 3rd+	BA (CG, EG, CO; AN - LA), CE, CZ, GA (BB2)
77	Q	early 3rd - 4th	CZ, EA, FM, GA (flanged bowl)
80	Q	mid 2nd - 3rd	CB, CZ, GA (BB2)
84	Q	mid 2nd - 3rd+	CZ, EZ, GA (BB2)
456	SQ	Roman	
926	SQ	mid 2nd - 3rd+	CE, CZ, GA (flanged bowl)
927	SQ	mid 2nd - early 3rd	GA (BB2)
979	SQ	3rd	CL, CZ, GA (BB2)
980	SQ	mid 2nd - 3rd+	CE, CZ, GA (BB2)



1000	SQ	mid 2nd - early 3rd	GA (BB2)
<b>Layer 7</b>			
33	SQ	mid 2nd - 3rd+	CZ, GA (BB2)
<b>Layer 8</b>			
51	SQ	Roman	
<b>Layer 9</b>			
53	Q	early 3rd - 4th	CH, CZ, GA (BB1 flanged bowl)
61	SQ	mid 2nd - early 3rd	GA (BB2)
<b>Layer 10</b>			
52	SQ	mid - late 2nd	BA (CO)
58	SQ	2nd - 3rd	CZ
66	SQ	mid 2nd - early 3rd	GA (BB2)
<b>Layer 11</b>			
9	SQ	mid 2nd - 3rd+	CH, CZ
10	NP		
12	SQ	Antonine	BA (EG, CO), GA (BB2)
17	Q	mid 2nd - 3rd+	CB, DA, EZ, GA (BB2)
22	Q	mid 2nd - early 3rd	EZ, GA (BB1 & 2)
37	SQ	mid 2nd - 3rd	CB, GA (BB2)
91	LQ	mid 2nd - 4th	CB, CZ, EA, EZ, GA (BB2)
93	SQ	mid 2nd - 3rd+	GA (flanged bowl)
932	HQ	Hadrianic - Antonine	BA (CG: HA - AN), CB, CZ, EZ, GA (BB2)
933	Q	Antonine	BA (CG: HA - AN, EG: AN), FM
<b>Layer 16</b>			
86	SQ	mid 2nd - early 3rd	GA (BB2)
90	NP		
116	Q	mid - late 2nd	CZ, GA (BB1 & 2)
154	SQ	mid 2nd - early 3rd	GA (BB2)
177	SQ	1st+	GY
387	NP		
418	NP		
440	1	Roman	
924	SQ	mid 2nd - early 3rd, PR	GA (BB2) PR (post-medieval)
<b>Layer 22</b>			
50	Q	mid 2nd - 3rd+	CZ, EA, GA (BB2)
63	Q	3rd - 4th	CH, EA

## APPENDIX 11

**Carbonised cereals and crop weeds from Buildings 38, 41, and 45 (Balkerne Lane)**

by Peter Murphy

This report is concerned with the plant remains from 30 soil samples taken by the excavator.

Methods

Most of the samples received for examination contained large quantities of cereal grains and fragments, with charcoal, pieces of burnt daub and relatively little soil.<sup>1</sup> Sub-samples were removed for examination from the larger samples. In Tables 1-6, the weights of samples received and the sub-sample weights are recorded.

Despite the relatively low soil content of these samples water flotation proved to be necessary, mainly to clean the grains and seeds. They were coated with fine soil particles which without flotation would have made detection and identification difficult. The flot was retained in a 250-micron-mesh sieve.

In most samples many of the grains were fragmentary. The weights of fragmentary grains are given in the tables. A hundred intact grains from each layer were also weighed so as to permit the conversion of fragment weights to approximate grain numbers if required.

### Identification

The samples from these sites presented certain difficulties. Frequently spikelet fragments can more confidently be assigned to a particular wheat species than can naked grains. Unfortunately, since these deposits were so 'clean' very few spikelet parts were isolated and in many samples chaff was absent. Consequently grain shape has had to be used as the main criterion for identification, though a complete quantitative separation of wheat species is not possible with this material.

Measurements of grains have been made and length : breadth (L/B x 100) and thickness : breadth (T/B x 100) ratios calculated for wheat samples from the three main deposits: JL36, KL77 and T416 (Figs 207-9). No attempt was made to separate grains into species-types before measurement; the histograms thus give an overall impression of the variation within these samples.

#### Layer JL36 (BKC Site J; Table 1; Building(s) 45, Room 6, p 108)

The cereal samples from this deposit are particularly 'clean', with no cereal chaff, and grain shape is the sole criterion which may be used in identification. The grains in this deposit are generally very fragmentary. This appears to result from their being incompletely carbonised; the interior fractured surfaces are frequently brownish rather than black, and there are translucent pericarp fragments clearly showing the rows of long transverse cells characteristic of wheat pericarps (cf Körber-Grohne 1964, 46). There are, however, some larger groups of well-preserved grains, of which 3683 is a good example (Figs 207-9). Elongate blunt-ended grains (mean L:B 193), rather flat (mean T:B 83) with broad ventral surfaces predominate in this sample; these are identified as Triticum spelta. Other forms include grains

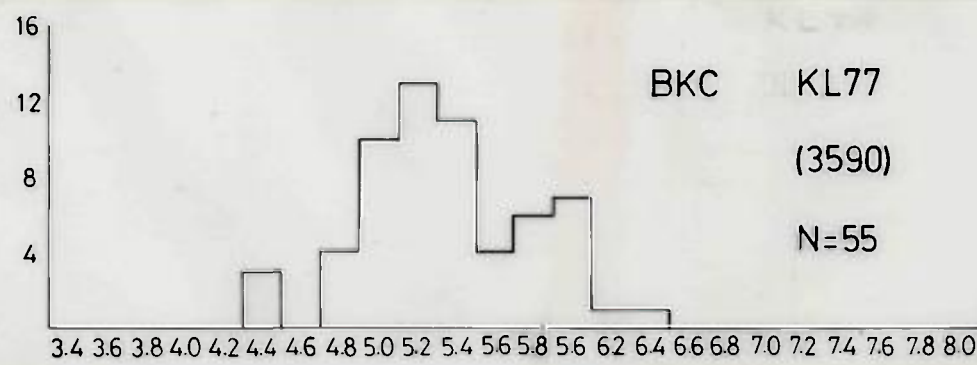
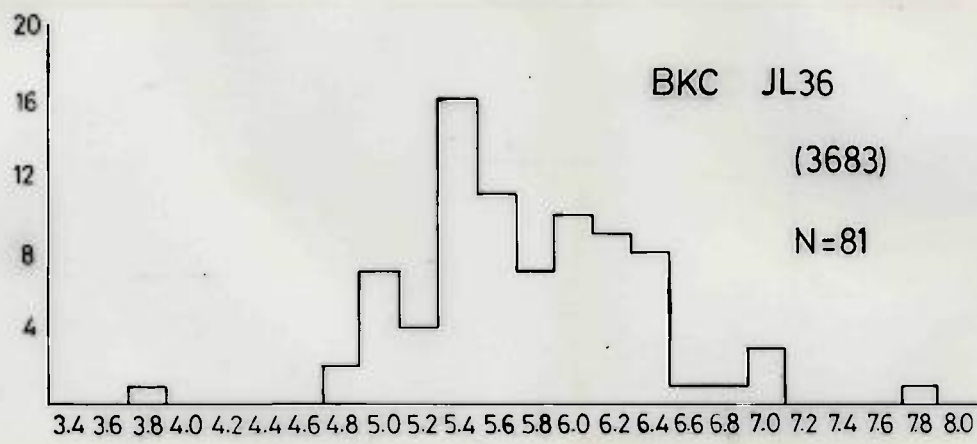
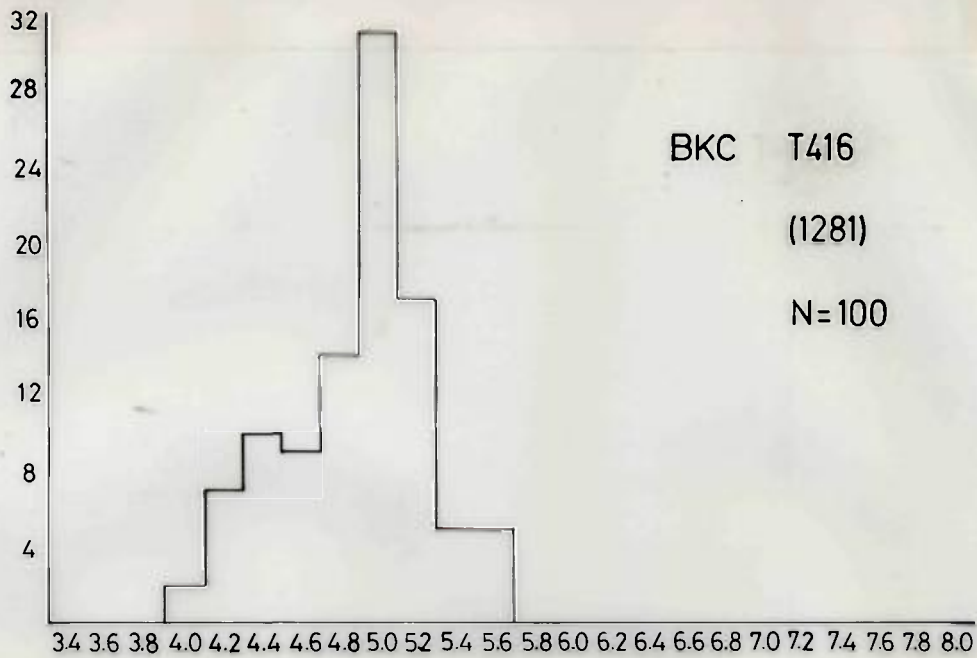


Fig 207. Wheat grains: lengths (mm).



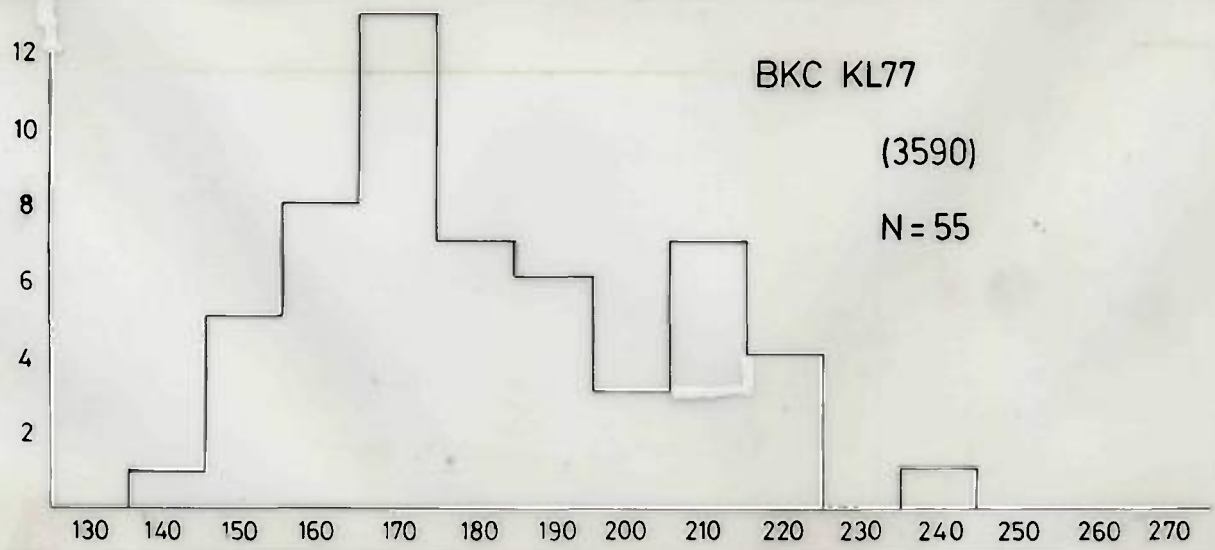
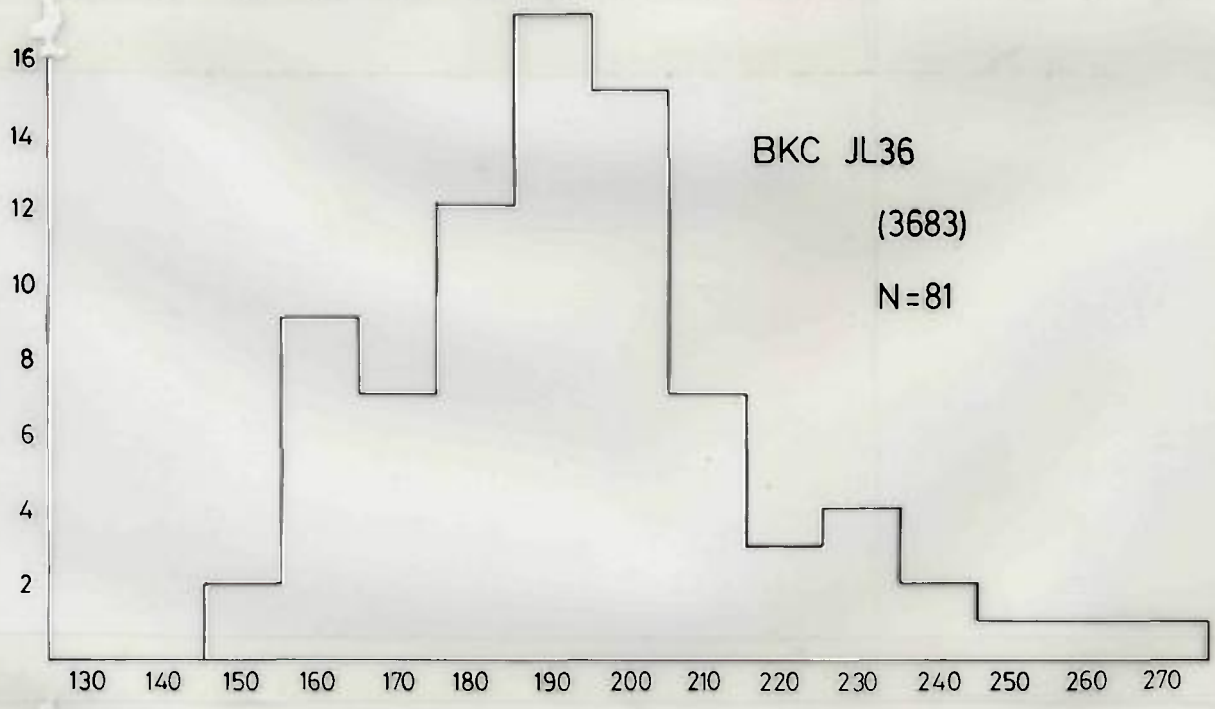
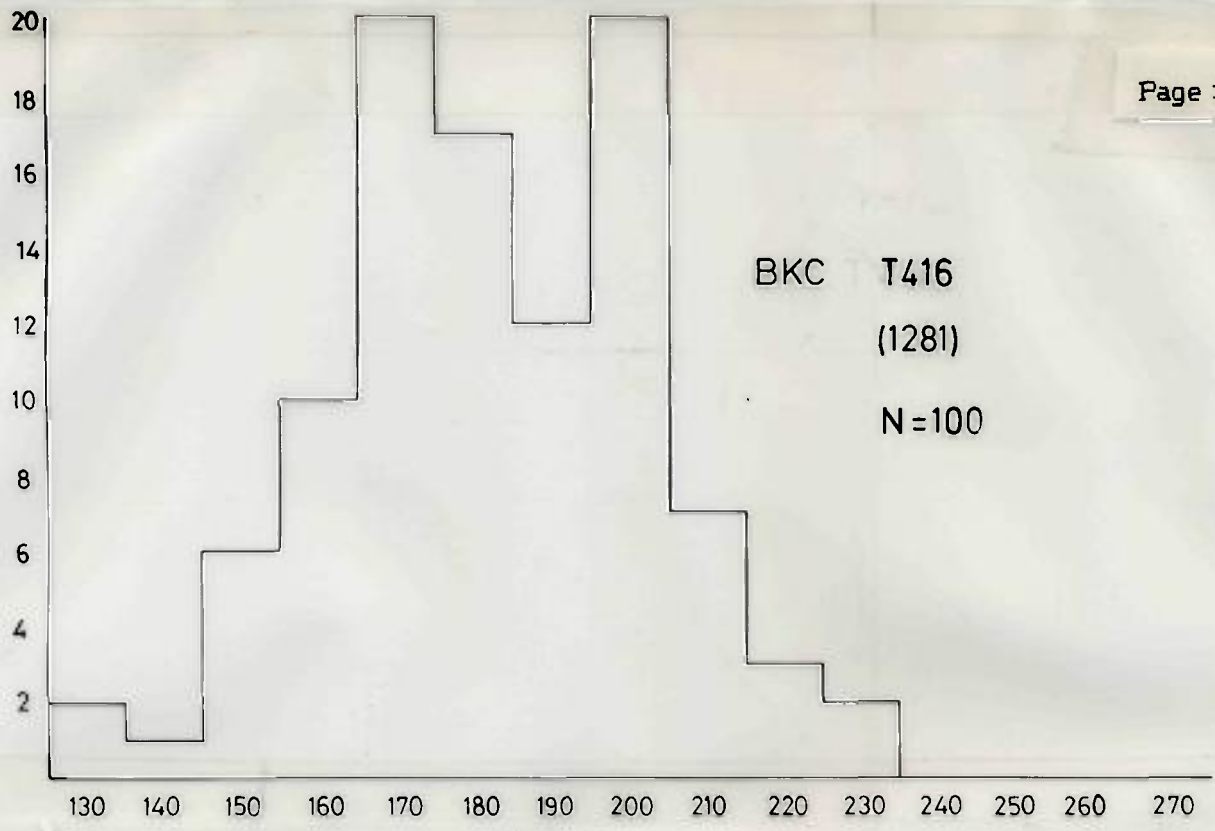


Fig 208. Wheat grains: L:B ratios (L/B x 100).



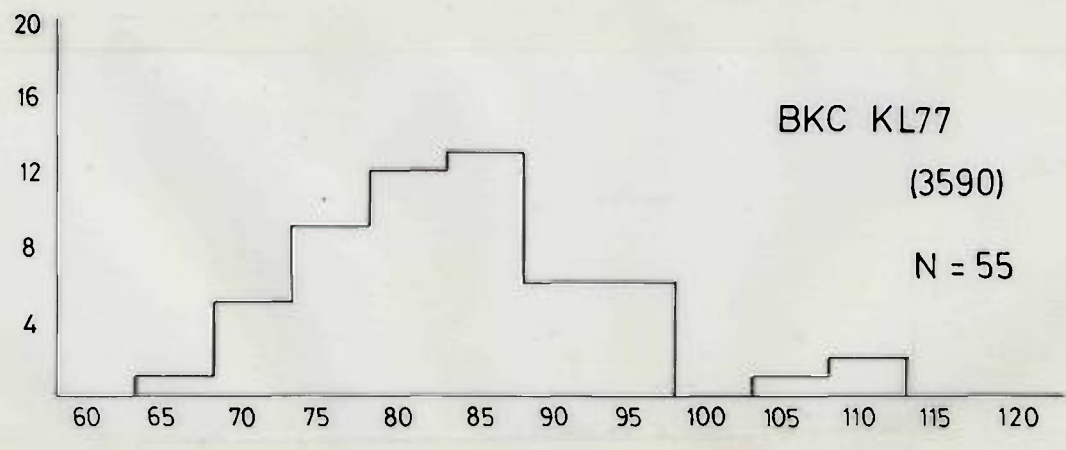
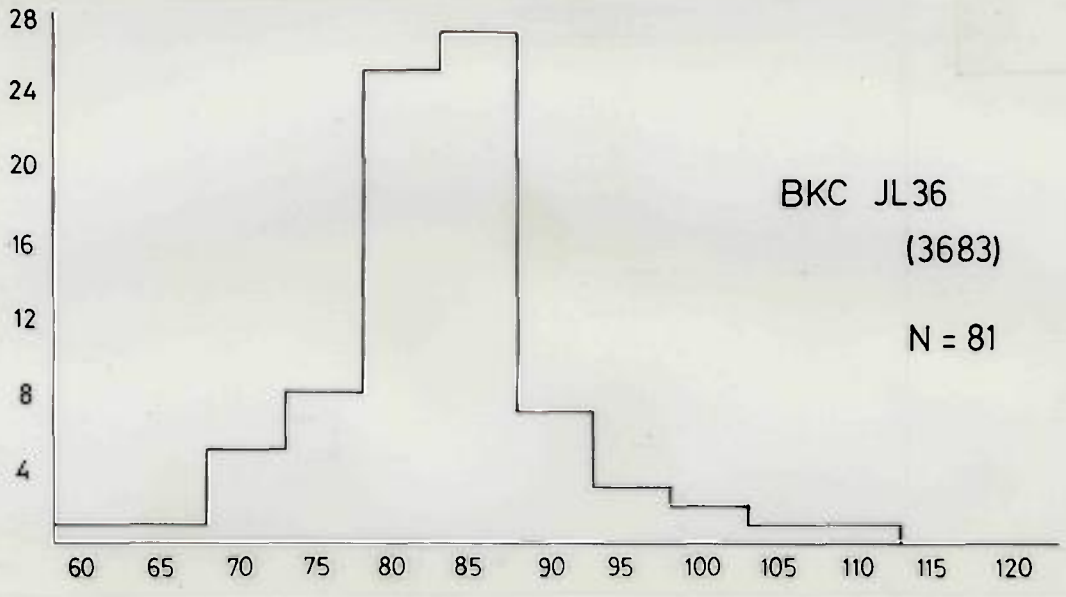
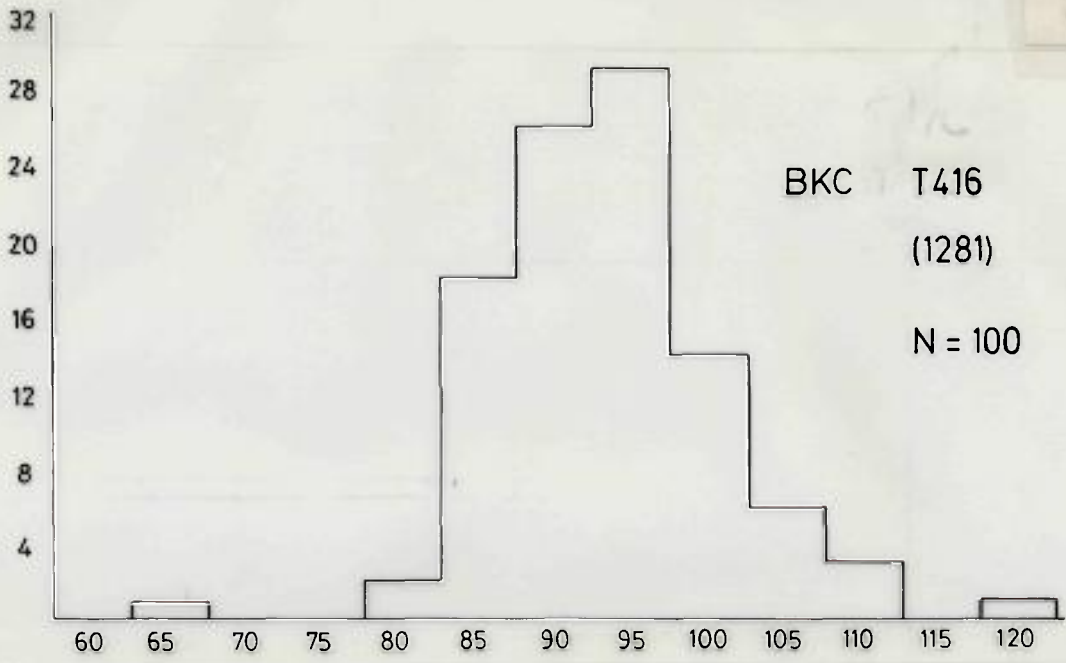


Fig 209. Wheat grains: T:B ratios (T/B x 100).

resembling bread wheat and intermediate types. Other samples from this layer contained a similar range of wheat grains, with varying proportions of short-grained forms.

Sample no	3537	3538	3539	3540	3541	3542	3577	3682	3683	3684	3685	3707	3708
<u>Triticum</u> spp	313	93	108	112	45	84*	188	125	387*	32	81*	139	53
caryopses													
<u>Hordeum</u> sp	-	1	-	3	-	1	2	-	1	-	-	-	-
hulled caryopses													
<u>Avena</u> sp	-	-	-	-	-	1	-	-	-	-	cf1	-	-
caryopses													
<u>Agrostemma</u>	1+cf2	4	-	1	2	-	9	3	8	-	1	5	3
qithago seeds													
<u>Corylus avellana</u>	-	-	+	-	-	-	-	-	-	-	-	-	-
nut-shell frags													
<u>Galium aparine</u>	1	-	-	-	-	-	-	-	cf1	-	-	-	cf1
seeds													
<u>Bromus mollis/</u>	-	-	-	1	-	-	-	3	-	-	2	1	-
<u>secalinus</u>													
caryopses													
indet	-	1	-	-	-	-	-	-	-	-	-	-	-
sample wt (gm)	105	30	65	20	75	535	65	480	700	185	115	210	55
sub-sample wt (gm)	105	30	65	20	75	100	30	100	100	100	115	100	55
cereal frags in sub-sample (gm)	14.5	10.9	6.8	4.6	9.8	7.6	6.5	15.5	25.6	17.3	9.1	12.5	24.9

Table 1. Cereals and crop weeds from Layer JL36. 100 grains from 3537, weighed 1.32 gm. \* Germinated grains present. Sample 3707 also includes Avena awn fragments.

Feature JF67 (BKC Site J; Table 2; Building(s) 45, Room 6, p 108)

This pit (JF67) cut Layer JL36 and contained seeds derived from it. No cereal chaff is present, but spelt-type grains predominate.

Sample no	3543
<u>Triticum</u> spp caryopses	117
<u>Agrostemma githago</u> seeds	1
<u>Bromus mollis/secalinus</u> caryopses	2
sample weight (gm)	520
sub-sample weight (gm)	100
cereal frags in sub-sample (gm)	2.2

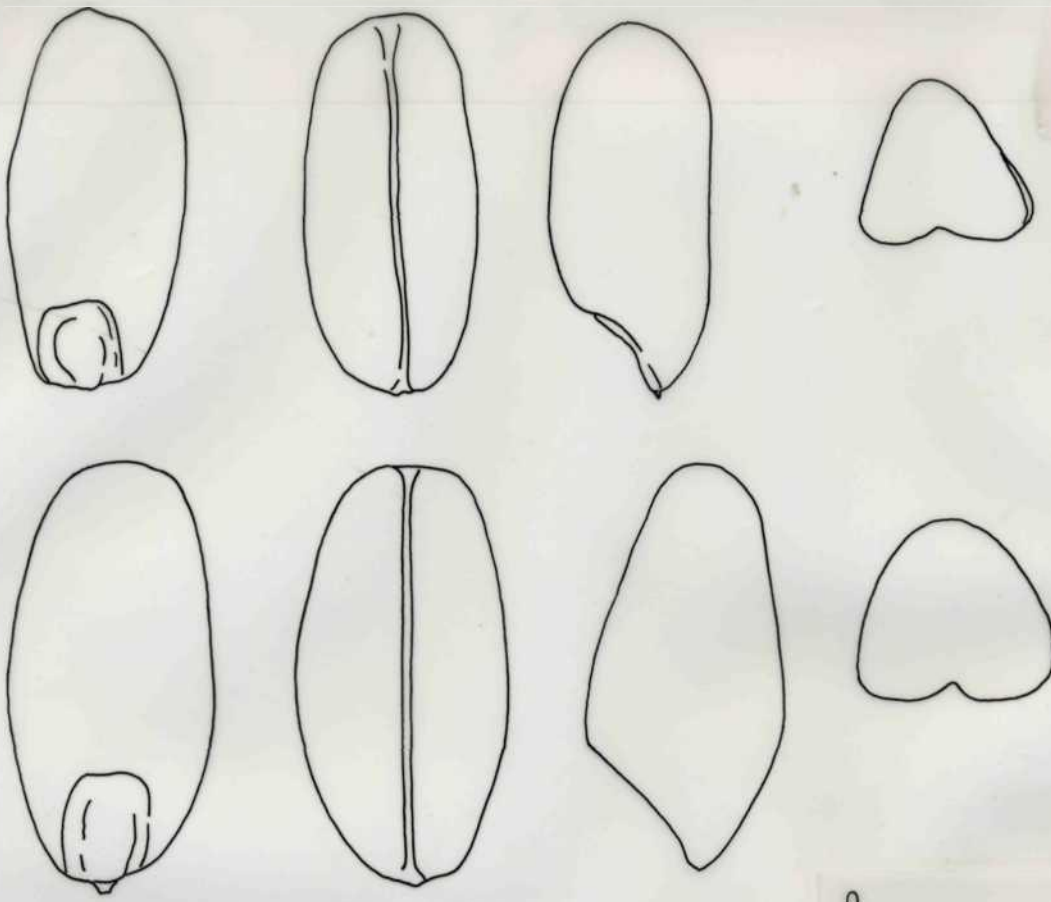
Table 2. Cereals and crop weeds from Feature JF67. 100 wheat grains weigh 1.42 gm.

Layer KL119 (BKC Site K; Table 3; Fig 210; Buildings 38, p 110)

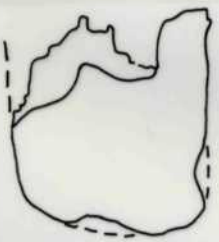
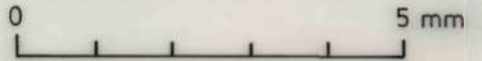
Sample 3852 produced fruits and seeds of Agrostemma githago and Bromus mollis/secalinus. The only cereal chaff recovered was a single damaged wheat rachis internode (Fig 210). This is a robust intermode from a brittle rachis wheat, more closely comparable to spelt than emmer. The grains from this sample are poorly preserved, but those from 3711 are mainly spelt-type grains, with a few plumper probable bread wheat-types.

Sample no	3711*	3852
<u>Triticum</u> spp caryopses	184	63
<u>Triticum</u> sp rachis internode	-	1
<u>Agrostemma githago</u> seeds	-	1
<u>Bromus mollis/secalinus</u> caryopses	-	1
sample weight (gm)	10	6880
sub-sample weight (gm)	10	500
cereal fragments in sub-sample (gm)	0.7	3.7

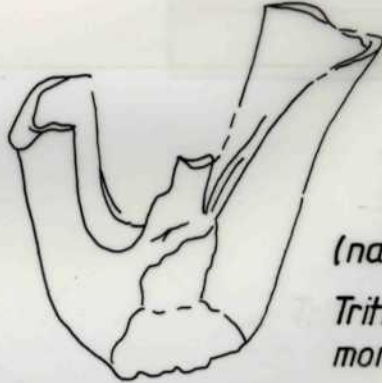
Table 3. Cereals and crop weeds from Layer KL119. 100 wheat grains from 3711 weigh 1.75 gm. (\* This small sample may have been biased by hand-selection on site.)



1281 *Emmer*

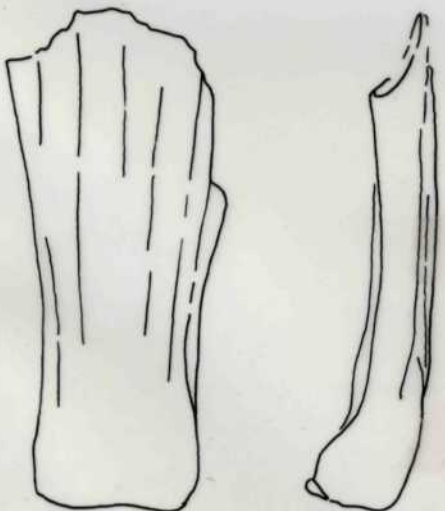


3852 (*rachis internode*)



3798

(*narrow spikelet fork*)  
*Triticum dicoccum* /  
*monococcum*



3625 (*T spelta* glume base)

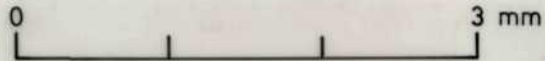


Fig 210. Cereal remains from Samples 1281 (BKC T416), 3852 (BKC KL119), 3798 (BKC KF121), and 3625 (BKC KL77).



Feature KF121 (BKC Site K; Table 4; Fig 210; Building 38, p 110)

Weed seeds were rare in these samples, but a few wheat spikelet fragments were recovered. Sample 3797 produced a narrow apical spikelet fork with no articulation scar for an ascending internode; its glume base width (1.12 mm) falls within the size range of spelt. The descending internode scar is at 90° to the normal orientation. The remaining glume has a splayed base, but unlike the specimens from 3590 (below) no central fold. Sample 3798 contained two typical spelt spikelet forks, and a very slender fork (Fig 210). This was not identified to species, but the attached glumes are very narrow and could be of either emmer or einkorn. Many of the grains are distorted, having germinated, but spelt-type grains predominate, with some bread wheat-types.

Sample no	3797*	3798
<u>Triticum</u> spp caryopses	169**	201**
<u>Triticum spelta</u> spikelet forks	1	2
<u>Triticum</u> sp spikelet fork	-	1
<u>Triticum</u> sp glume base (damaged)	-	1
Leguminosae indet seeds	-	2
<u>Bromus mollis/secalinus</u> caryopses	1	3
<u>Hordeum vulgare</u> caryopses	1	3
sample weight (gm)	40	325
sub-sample weight (gm)	40	30
cereal fragments in sub-sample (gm)	4.0	4.3

Table 4. Cereals and crop weeds from Feature KF121. 100 grains from 3798 weigh 1.34 gm. \*\* These samples include germinated grains. (\* This small sample may have been biased by hand-selection on site.)

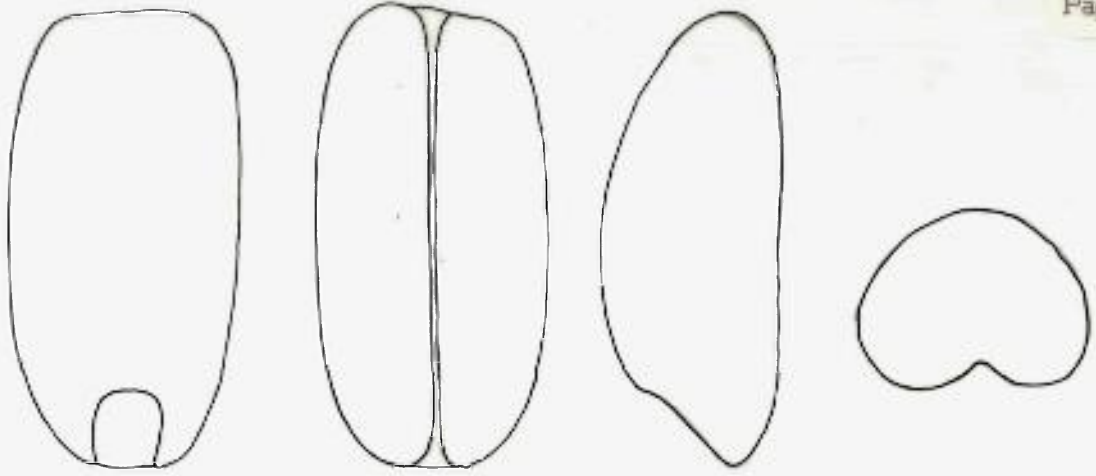
Layer KL77 (Samples 3547, 3590, 3624, 3625, 3678) (BKC Site K; Table 5; Figs 207-12; Building 38, p 110)

Samples from this layer contained slightly more impurities than those

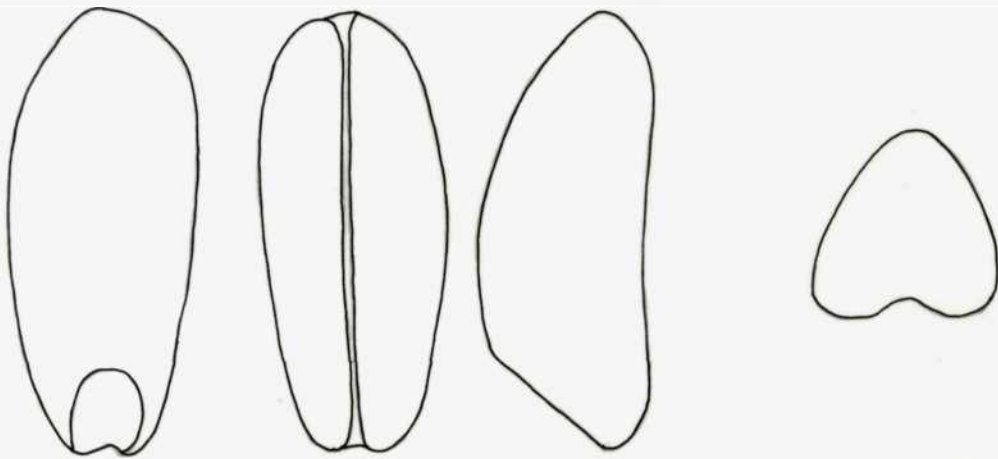
from other deposits at the site. Small vetch seeds and cotyledons, often lacking their hilums and therefore not closely identifiable were found in four sub-samples. Two specimens from 3590 and 3625, however, had narrow linear hilums, and are identified as Vicia hirsuta. Dimensions of the specimen from 3590 were: seed 2.0 x 2.0 x 1.4 mm, hilum 1.4 mm. Sample 3678 produced a large elongate abraded cotyledon, 4.7 x 3.4 mm, possibly a poorly-developed specimen of Vicia faba var minor. Fruits, seeds and fragments of Hordeum vulgare, Avena sp, Agrostemma githago, Polygonum cf aviculare, Corylus avellana, Bromus sp, and unidentified Gramineae were also present.

Most of the cereal chaff consists of glume bases and spikelet forks of spelt, Triticum spelta. The spelt glume bases show a characteristic venation, with one prominent marginal vein, and the glume base widths fall in the range 0.90-1.38 mm (Fig 210; Table 7). In addition 3590 contained two unusual bases each with a central longitudinal fold and splayed base (Fig 212). These specimens are both lower glumes from terminal spikelets of spelt.<sup>2</sup>

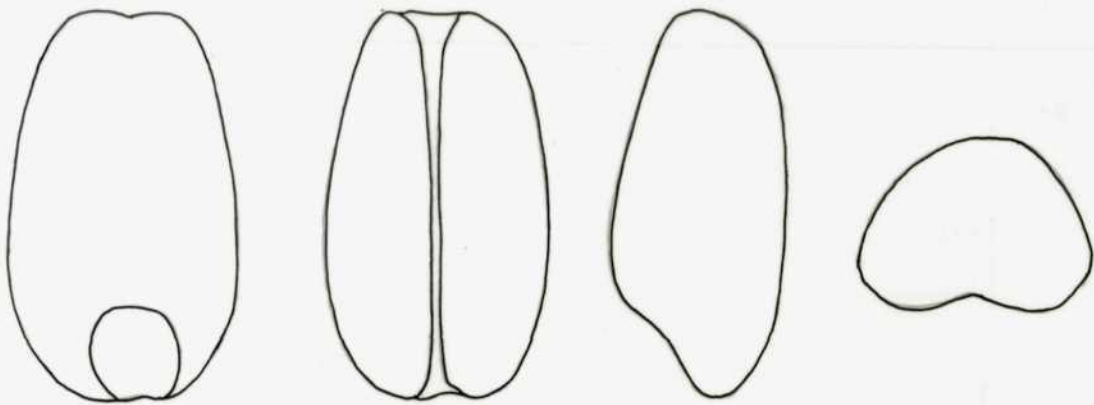
The wheat grains from 3590 were the best preserved specimens from this layer. Three main forms can be distinguished, though a continuous range of intermediate types is present (Figs 207-9 & 211). Typical elongate spelt-type grains with blunt apices, more or less parallel sides and low T:B ratios (around 80-85) are fairly common, and there are a few slender grains with high L:B ratios (up to 236) and high T:B ratios (>100) which resemble spelt harvested at the 'doughy' ripe stage. Many of the grains, however, are shorter (L:B around 170), often with maximum widths just above the embryo. Some of these, having steeply-placed embryos, closely resemble bread wheat grains, whilst others have more oblique embryos and are flatter. Specimens of



*T spelta-type*



*T spelta-type ? immature*

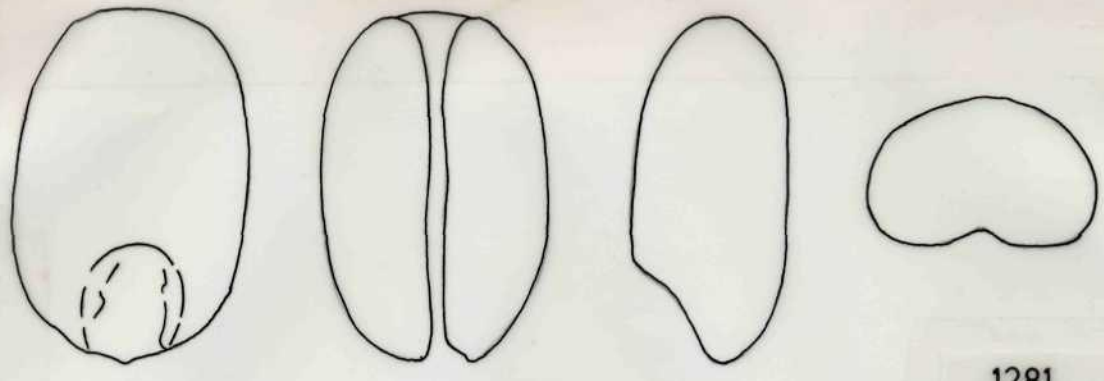


*T aestivum / spelta-type*

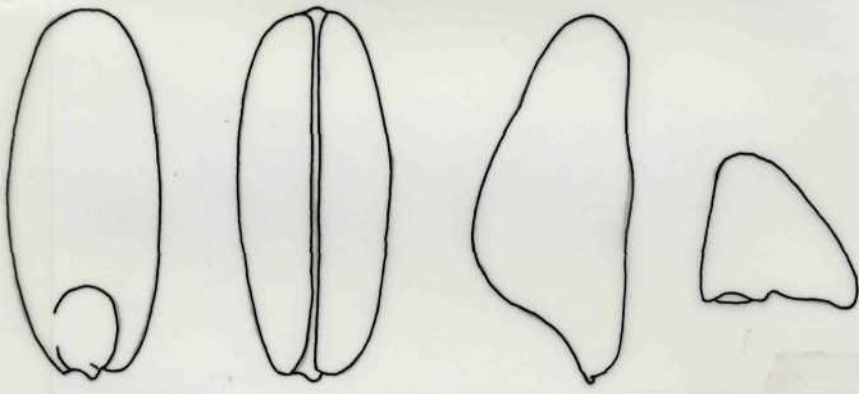
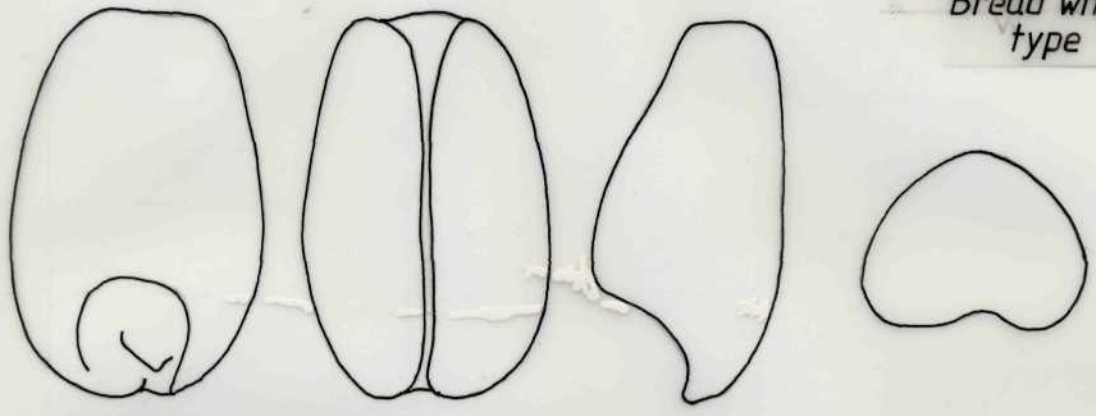


Fig 211. Wheat grains from Sample 3590 (BKC KL77).

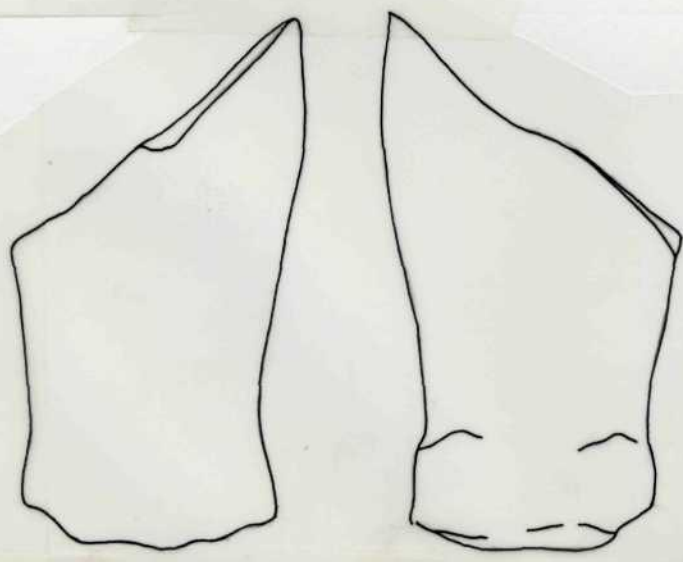
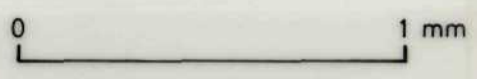




1281  
*Bread wheat*  
*type*



1281  
*immature emmer*



3590  
*T. spelta*  
*lower-glume from terminal spikelet*



Fig 212. Cereal grains from Sample 1281 (BKC T416) and glume from Sample 3590 (BKC KL77).



this type are described by Van Zeist (1970, 104).

Sample no	3547**	3590	3624	3625	3678**
<u>Triticum</u> spp caryopses	113	261	244	244	150*
<u>Triticum spelta</u> glume bases	-	2	3	4	2
<u>Triticum spelta</u> spikelet forks	-	1	1	-	-
<u>Triticum spelta</u> glume bases (terminal spikelets)	-	2	-	-	-
<u>Triticum</u> sp spikelet forks	-	-	-	2	-
<u>Hordeum vulgare</u> hulled caryopses	-	1	4	2	-
<u>Avena</u> sp caryopses	-	-	-	cf2	-
<u>Avena</u> sp awn fragments	-	-	-	+	-
<u>Agrostemma githago</u> seeds	-	5	-	4	1
<u>Vicia hirsuta</u> seeds	-	1	-	1	-
<u>Vicia</u> sp seeds	-	-	-	2	1
Leguminosae indet seeds	-	1	3	1	-
<u>Polygonum</u> cf <u>aviculare</u> nutlet	-	-	-	1	-
<u>Corylus avellana</u> nutshell frags	-	-	+	-	+
<u>Bromus mollis/secalinus</u> caryopses	-	1	2	4	-
Gramineae indet	-	-	1	-	-
sample weight (gm)	15	3780	1500	4620	300
sub-sample weight (gm)	15	100	100	100	300
cereal fragments in sub-sample (gm)	2.8	10.2	8.4	11.3	6.4

Table 5. Cereals and crop weeds from Layer KL77. 100 wheat grains from 3625 weighed 1.48 gm. Sample 3624 includes some probable Triticum awn fragments.  
\* Samples including germinated grains. (\*\* These small samples may have been biased by hand selection on site.)

Context T416 (BKC Site T; Table 6; Figs 207-10 & 212; **Building 41**, p 105)

Samples from T416 included very few impurities, apart from a few caryopses and seeds of Hordeum vulgare, Agrostemma githago and Bromus mollis/secalinus. No cereal chaff was recovered, and identification of the wheats must therefore depend on grain shape (Figs 207-9). The best-preserved grains came from 1281. Many of these are elongate (L:B around 200) with asymmetrically triangular cross-sections and fairly high T:B ratios (mean, 95). These are identified as emmer, Triticum dicoccum. Shorter grains are also present. Some of these are probably distorted emmer grains, but others are distinctly plump with steeply placed embryos and identified as bread wheat

(T aestivum). There are a few drop-shaped grains, immature emmer grains and at least one specimen showing signs of germination.

Sample no	1040	1041	1281
<u>Triticum</u> spp caryopses	244	62	281
<u>Hordeum vulgare</u> caryopses	1	-	5
<u>Agrostemma githago</u> seeds	1	-	1
<u>Bromus mollis/secalinus</u> caryopses	1	-	-
Gramineae indet	-	1	-
sample weight (gm)	1080	1985	2750
sub-sample weight (gm)	100	1985	685
cereal fragments in sub-sample (gm)	7.0	1.9	18.0

Table 6. Cereals and crop weeds from context T416. 100 wheat grains from 1281 weighed 1.35 gm.

Context no	Sample no	Taxon	Type of material	Glume base width (mm)
KL77	3624	<u>T spelta</u>	glume bases (3) spikelet fork (1)	1.10, 1.20, 1.28 about 1.20
KL77	3625	<u>T spelta</u> <u>Triticum</u> sp	glume bases (4) spikelet fork	0.90, 1.02, 1.30, 1.38 not measureable very slender
KL77	3678	<u>T spelta</u>	glume bases (2)	not measureable
KL77	3590	<u>T spelta</u>	glume bases (2)* spikelet fork (1)	1.14, 1.16 1.16
KF121	3797	<u>T spelta</u>	spikelet fork (terminal)	1.12
KF121	3798	<u>T spelta</u> <u>Triticum</u> sp	spikelet forks (2) spikelet fork	1.24, 1.30 not measureable very slender
		<u>Triticum</u> sp	glume base	not measureable

Table 7. Dimensions of wheat glume bases from Balcerne Lane Site K, Building 38. \* Widths of lower glumes from terminal spikelets not measured.

Context no	Main wheat species	Other wheat species	Other cereals	Spikelet fragments	Weed seeds	Germinated grains
BKC JL36	<u>T spelta</u>	<u>T aestivum</u>	<u>Hordeum</u> sp <u>Avena</u> sp	0	+	+
BKC JF67	<u>T spelta</u>	? <u>T aestivum</u>	-	0	+	-
BKC KL77	<u>T spelta</u>	<u>T aestivum</u>	<u>H vulgare</u> <u>Avena</u> sp	+	+	+
BKC KL119	<u>T spelta</u>	? <u>T aestivum</u>	-	+	+	-
BKC KF121	<u>T spelta</u>	? <u>T aestivum</u>	<u>H vulgare</u>	+	+	+
BKC T416	<u>T dicoccum</u>	<u>T aestivum</u>	<u>T dicoccum/monococcum</u> <u>H vulgare</u>	0	+	single specimen

Table 8. Summary of the principle features of the deposits.

### General discussion

Most of our knowledge of Roman cereal crops comes from carbonised grain assemblages from secondary refuse contexts. Although such assemblages do provide information about the range of species cultivated, and some data on the character of the weed flora, it is inevitable that there will have been a mixing of cereals and crop weeds from a variety of sources in refuse deposits. This problem does not exist when one is dealing with the remains of stored crops found more or less in situ within buildings and consequently deposits of this type can provide information about the nature of the stored crop, its purity and condition. In particular it may be possible to determine whether monocultures or maslin crops were being grown, to draw some conclusions about the efficiency of grain cleaning techniques, and to assess the prevalence of losses in store due to fungal and insect infestation and to germination.

The composition of the cereal deposits at this site is summarised in Table 8. They consist principally of spelt (with the exception of T416, which produced mainly emmer), and all samples produced a proportion of bread wheat-type grains. Intermediate forms of indeterminate species are also common. Six-row hulled barley and oat grains occur sporadically at low frequencies.



The homogeneity of the deposits provides grounds for the belief that each deposit represents a single harvested crop rather than a mixture, after harvesting, of cereals grown separately. Consequently it seems that tough and brittle rachis wheats were grown together as a type of maslin crop. Jones (1978, 103) notes that the Hexaploids, bread wheat and spelt, are fairly interfertile and that when they are grown together some 'rogues' with intermediate characteristics were produced. Histograms of grain measurements and ratios, such as Figures 207-9 may (apart from grains distorted during carbonisation) represent genetically diverse populations of wheats, including the two parent wheats and possibly a proportion of hybrids. The advantages of such diversity are clear: although the high yields obtained with modern monocultures could never be achieved, variations in yield due to extremes of weather and to disease would have been minimised, and a consistent yield obtained.

The deposits contain few impurities. Spikelet fragments and contaminant fruits and seeds, including barley and oats, are very rare. On a weight basis these contaminants are quite insignificant. The weed seeds present are generally large forms - corn-cockle, vetches and large grasses. The cereals were therefore efficiently threshed, winnowed and possibly sieved before storage, and the only impurities remaining are a proportion of those large components which could not have been removed without discarding excessive amounts of the crop itself.

The grains show no obvious signs of insect attack, and no fungal sclerotia were observed. The proportion of germinated grains cannot be precisely determined, but is low. It is generally considered that spelt and emmer must be dried before threshing (Helbaek 1953, 233), in order to ensure complete release of the grains. This drying would have destroyed viability,



or if incomplete reduced the percentage of viable grains. The few germinated specimens present in these deposits may represent grains sprouted in the ear, or grains which were only slightly heated during drying, and subsequently germinated in store; it appears that losses due to germination would have been very slight.

#### Notes

1. These sites were excavated, and samples taken, before I began working in the area. I am informed that there was some hand-selection of cereals on site, which may have biased the samples in some cases. This does not apply to the large bulk soil samples, but some of the smaller samples are suspect.
2. Kindly identified by Gordon Hillman, Department of Plant Science, University College, Cardiff.

## APPENDIX 12

## Soil monolith through Period 5 cultivated soil at

## Balkerne Lane Site V

by P Murphy

A soil monolith including Layers VL22, VL5, VL87, and the upper part of the natural gravel was received for examination (p 140). The deposits in this monolith were as follows:

- 0-10 cm      Layer 22. Dumped material c. AD 275-300.  
Heterogeneous friable dark brown to brown (7.5 YR 4/2; 5/4) coarse sandy loam with patches of clean sand; flint pebbles up to 3 cm; pottery, mortar/plaster, charcoal, seeds, fishbone, mammal-bone fragments, oyster and mussel shell fragments; sharp boundary.
- 10-50 cm      Layer 5. Cultivated soil.  
Fairly homogenous brown (7.5 YR 4/3) friable coarse sandy loam with darker and lighter patches; flint pebbles up to 5 cm; pottery, glass, mortar/plaster, charcoal, seeds, fishbone, small-mammal bone, bone fragments, oyster and mussel shell fragments; boundary not clear.
- 50- c. 100 cm      Layer 87. Layer beneath cultivated soil. 1st century.  
(a) 50- 80 cm. Brown (7.5 YR 4.5/4) friable coarse sandy loam with darker and lighter patches; flint pebbles up to 6.5 cm; merging boundary.

(b) 80-c 100 cm. Yellowish brown (10 YR 5/4) loamy coarse sand; flint pebbles up to 4 cm. Both portions include pottery, charcoal, seeds, bone fragments, mussel and oyster shell fragments. Junction with natural gravel obscured by F136, a 1st-century slot.

c 100-120 cm Natural gravel.

Loose yellowish-brown (10 YR 5/7) coarse sandy matrix; flint pebbles up to 3 cm.

These deposits are slightly acidic (pH 6.5). This is too alkaline for good preservation of pollen, but on the other hand sufficiently acidic to ensure destruction of land mollusc shells.

In an attempt to recover any carbonised plant remains which might be relevant to an interpretation of the cultivated soil, charcoal fragments and other plant material were extracted from 1 kg soil samples by flotation, collecting the flot in a one-millimetre-mesh sieve. However, only a few poorly-preserved seeds were retrieved, mainly of common weeds. These were:

Layer 22     Sambucus nigra (elder),     Rubus fruticosus (bramble)

Layer 5     Lathyrus sp (vetchling),     unidentified Labiate

Layer 87     Ranunculus sp (buttercup),     Chenopodium album (fat-hen),  
unidentified Labiate, Sambucus nigra, unidentified cereal  
(fragment)

## Appendix 13

**Summary of the products of the Roman kiln F1019 at Middleborough**

by R. P. Symonds with a contribution by K. F. Hartley

[Fig 213, microfiche; kiln illustrated and described on pp 182-4 in the printed text]

Below is a summary of the fabrics present in the archaeological contexts associated with the Roman pottery kiln at Middleborough. (For a key to the abbreviations, see Appendix 10). This shows, in marked contrast with the pottery from areas of occupation at Middleborough, Balcerne Lane and Lion Walk, an abnormally high concentration of white wares, mainly flagons (FA) and mortaria (FM), the former constituting more than 50% of all the pottery from these contexts. A group of forms which appear to represent most of the kiln products is shown in Fig 213. These include ring-topped, disk-mouthed, and plain-mouthed white-ware flagons, reeded-rim bowls, and plain white mortaria with quartz grits (which occur only inside the bowl, rather than also trailing over the rim, as on pre-Flavian examples). That these represent the kiln's production is also demonstrated by the presence of a small number of very contorted wasters in identical fabrics, but a programme of petrological and chemical analysis of all of the coarse ware fabrics present will need to be undertaken before firm conclusions are reached on the homogeneity of the group. Vessels of these forms are found elsewhere in Colchester predominantly in contexts dated from the 4th quarter of the 1st century to the first quarter of the 2nd century. Only one mortarium stamp has been noted in the group, ie of VEERVS, of which there are three identical examples. There is no mention of this potter in The Roman Potters' Kilns of Colchester (Hull 1963), and no other examples of his stamp have been found in the recent excavations of the Colchester Archaeological Trust.



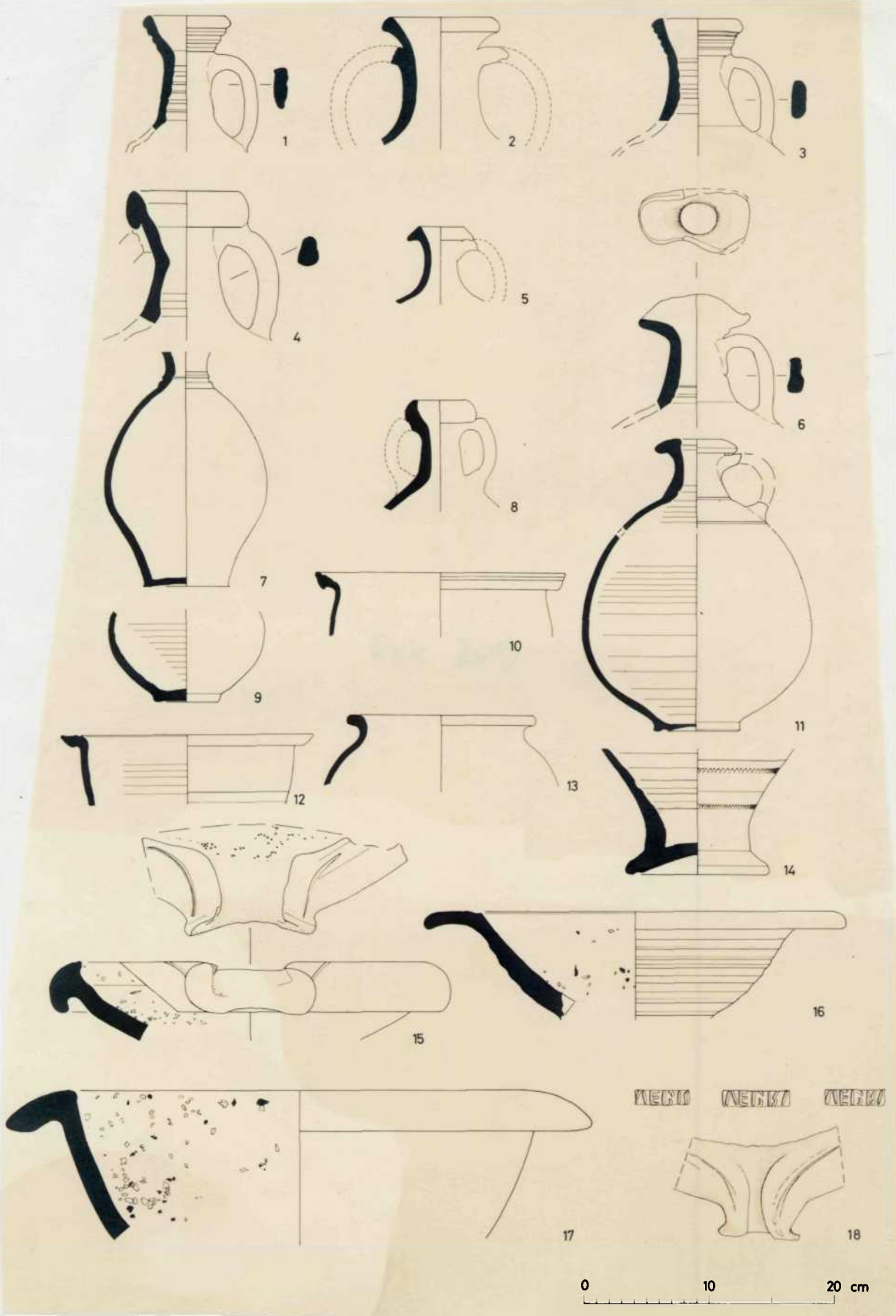


Fig 213 Selection of the pottery forms from the kiln F1019

A summary of the fabrics present in the Middleborough kiln contexts (by quantity, weight, & percentage by weight)

Feature/layer, Find no, date:

AA BA CE CS CZ DB FA FM GY GZ HZ Totals

F1019 (pottery kiln), 3340, late 1st century +:

q	V5Q	1	1	5Q	5Q	2	1	V5Q	5Q	
gm	335	10	10	545	1145	435	5	720	3205	
%	10.5	0.3	0.3	17.0	35.7	13.6	0.2	22.5	7.4	

F1019 (pottery kiln), 3341, late 1st century +:

2	1	5Q	V5Q	V5Q	1	V	V	Q
110	30	210	3600	555	30	1000	152	5687
1.9	0.5	3.7	63.3	9.8	0.5	17.6	2.7	13.1

F1019 (pottery kiln), 3368, late 1st century:

1	1	1	2	1	1	5Q
90	20	35	382	55	30	612
14.7	3.3	5.7	62.4	9.0	4.9	1.4

F1024 (pit), 3375, late 1st century:

1	V5Q	5Q	V5Q	V5Q	Q
15	505	6570	1600	580	9270
0.2	5.5	70.9	17.3	6.3	21.3

F1024 (pit), 3376, 1st century +:

1	1	1	V5Q	V5Q
20	30	10	245	305
6.6	9.8	3.3	80.3	0.7

L594 (pottery kiln), 3374, 1st century +:

V5Q	5Q	5Q	1	2	1	5Q
140	350	430	105	45	90	1160
12.1	30.2	37.1	9.1	3.9	7.8	2.7

L585 (pottery kiln), 3339, Roman:

2	1	2	V5Q	5Q
840	15	430	40	1325
63.4	1.1	32.5	3.0	3.0

L585 (pottery kiln), 3371, 1st century +:

V5Q	1	V5Q	V5Q	Q	V5Q	5Q	Q
1290	85	1150	1550	9435	2950	380	16840
7.7	0.5	6.8	9.2	56.0	17.5	2.3	38.6

L587 (pottery kiln), 3342, 1st century +:

1	2	1	VSO	SO
50	80	80	255	465
10.8	17.2	17.2	54.8	1.1

L588 (pottery kiln), 3343, 1st century +:

2	VSO	1	VSO	1	SO
335	1420	700	820	80	3355
10.0	42.3	20.9	24.4	2.4	7.7

L588 (pottery kiln), 3344, Roman:

1	1	VSO	1	SO
220	170	200	45	635
34.7	26.8	31.5	7.1	1.5

L589 (pottery kiln), 3354, Roman:

2	VSO	VSO	SO
40	55	50	145
27.6	37.9	34.5	0.3

L592 (pottery kiln), 3369, 1st century +:

1	2	2	1	SO
505	45	25	15	590
85.6	7.6	4.2	2.5	1.4

Totals:

q	SO	2	SO	VSO	1	SO	Q	SO	VSO	SO	SO	Q
gm	3185	105	235	1150	10	3895	23752	6670	90	4135	367	43594
%	7.3	0.2	0.5	2.6	0.02	8.9	54.5	15.3	0.2	9.5	0.8	

A summary of the fabrics from the timber well (F1020) at Middleborough:  
 (The presence of Nene Valley ware, and the markedly lower proportion of oxidized wares (DB & FA) suggests that although some of the contents of the well may be kiln debris, most of it is residual).

F1020, all Find nos, mid-2nd to early 4th century:

AA	BA	CB	CE	CS	CZ	DB	EA	FA	FM	GA	GY	GZ	HZ	T
2	5	2	5	V	2	1	V	V	V	S	V	S	V	Q
970	160	15	365	665	200	10	46	1095	1590	735	402	1565	1630	9448
10.3	1.7	0.2	3.9	7.0	2.1	0.1	0.5	11.6	16.8	7.8	4.3	16.6	17.3	

Stamped mortaria from the Middleborough kiln by K F Hartley

The three stamps (MID 3341, 3341, & 3375) are from one die and no other examples are known. They read either VEBRI (or V) retrograde or XEBRII, with R upside down; it is not uncommon to have the odd letter reversed. No potter is known with the former name but the second interpretation could easily be equated with the rarely found stamps of Aebris whose stamps are known from Brixworth, Northants (Woods 197X, 32, Fig 33, no 242) and one, possibly from London, in the Ransome Collection (Museum of Archaeology and Ethnology, Cambridge).

The fabric of the Brixworth mortarium, at least, indicates manufacture at some such pottery as those at Brockley Hill or Radlett in the Verulamium region. There is, however, some similarity in the style of lettering used in the Middleborough stamps and also in the rim-profiles. There are now several potters who are believed to have begun their activity in the Colchester region and later moved to the Verulamium region. The rim-profiles of the Brixworth and Middleborough mortaria would all fit a date in the Flavian or Flavian-Trajanic period.



## APPENDIX 14

## Miscellaneous soil samples from Middleborough

by Peter Murphy

The samples received for examination were in general of dry sandy sediments mostly unsuitable for the preservation of biological remains. They have been examined relatively rapidly.

Few conclusions can be drawn from the results. The contents of the pots do not differ significantly from typical medieval and post-medieval refuse deposits. The samples from the medieval drains are similar in character; only 169 (F786) produced definite evidence for the presence of water (ostracods). Sample 21 (L114) contained relatively large quantities of charred plant material, presumably representing a slow accumulation from a variety of sources. The deposit from the flue of the Roman kiln (F1019) has some resemblances to an organic lake mud, but I can offer no explanation for its presence. The mineralised fruitstones are all of species common in medieval and post-medieval contexts.

All samples dry unless otherwise noted.

Contents of whole pots buried upright (medieval and post-medieval):

Pot C441 (2.0 kg)	Sample of coal & coal dust with some sand
Pot F242, 779 (0.9 kg)	Dark greyish-brown (10 YR 3.5/2) sandy loam with brick/tile fragments, small quantity of charcoal, two seeds of <u>Sambucus nigra</u> , bone

- fragments, cockle-shell frags.
- Pot F271, 33 (1.2 kg) Brown (10 YR 4/2; 4/3 (speckled) sand with brick/tile fragments, coal, small charcoal frags, one S nigra seed
- Pot F830, 2581 (1.2 kg) Dark reddish brown (5 YR 3/3) sandy clay loam with pottery, brick/tile frags, bird bone, small bone frags, mussel shell.

Four samples from medieval well F136, (wet). Not examined because the samples produced 18th-century pottery and thus were from the backfill.

Samples from medieval drains:

- F114 (1.0 kg) Brown (7.5 YR 5/4; speckled) sand with brick/tile frags, coal, small charcoal scraps, ? intrusive insects, fish-scales, bone fragments, shell fragments of cockle and Helix aspersa.
- F786 (0.4 kg) Dark brown (7.5 YR 4/2) sandy silt loam with pottery, mortar/plaster, charcoal, small mammal and amphibian bone, shells of Discus rotundatus (2), Helix aspersa (frags), Trichia hispida (cf 1), Limacidae (1), Zonitidae (1), ostracod valve.

Sample of topsoil layer of pre-mid-13th-century date:

- L114 (7.7 kg) Very dark greyish-brown (10 YR 2.5/2) sandy loam with pottery, large tile/brick fragments; abundant charcoal, fruits and seeds of S nigra (3), Conium maculatum (5

frags), Leguminosae indet, Gramineae (caryopses in lemma and palea), Triticum sp (4 wheat caryopses), grass culm node, small mammal bone, bone fragments, shell fragments of oyster, mussel, whelk.

Sample from the flue of the 1st-century pottery kiln F1019:

(0.4 kg; wet)            Very dark brown (10 YR 2/1.5) silty clay. Much amorphous organic detritus and ? thallus fragments of Chara sp.

Sample from post-medieval pit F45

Prunus cf spinosa (sloe; 4 mineralised)

Sample from medieval stone-lined latrine pit F87

Prunus cf avium (cherry; 7 mineralised)

Prunus sp (5 mineralised)

Sample from post-medieval make-up L234

Prunus avium (cherry; 1 mineralised)

Sample from medieval/post-medieval pit F486

mineralised stem & wood fragments

Sample from post-medieval drain F211

clay concretion

## APPENDIX 15

## Significant charcoal samples

identified by A J Gouldwell and Maisie Taylor

## LION WALK

## Site B

607	cellar F70	<u>Quercus</u> sp
608	cellar F70	<u>Quercus</u> sp
609	cellar F70	<u>Corylus avellana/Alnus glutinosa</u>
626	cellar F70	<u>Viburnum</u> sp
627	cellar F70	<u>Viburnum</u> sp
640	cellar F70	<u>Quercus</u> sp
645	cellar F70	<u>Quercus</u> sp
647	cellar F70	<u>Quercus</u> sp
F150	Period 2 burnt drain	<u>Quercus</u> sp
F238	burnt Per 1 rampart	<u>Quercus</u> sp
F253	burnt Per 2 timbers	<u>Quercus</u> sp

## Site G

95	'charcoal spread' in yard	<u>Quercus</u> sp & <u>Buxus sempervirens</u>
182	in spread of broken peg-tile	<u>Corylus avellana/Alnus glutinosa</u>

## Site H

227	in Anglo-Saxon hut, probably insignificant	<u>Corylus avellana</u> (two pieces, one 'wattle-sized' and another bigger)
-----	--	---

## Site J

35	lime pit F16	probably <u>Quercus</u> sp
250	lime pit flue F188	<u>Quercus</u> sp
449	lime pit flue F135	very compressed, probably <u>Quercus</u> sp
1279	Per 2 burnt timber drain F315	<u>Quercus</u> sp
1075	Per 3 burnt slot F352	<u>Quercus</u> sp & <u>Rhamnus cathartica</u>
1446	Per 1 occ with AE flecks	<u>Quercus</u> sp
1660	daub block wall F420	<u>Quercus</u> sp
1661	daub block wall F420	<u>Quercus</u> sp
1665	east ground-plate Per 2 F540	<u>Quercus</u> sp
1666	west ground-plate Per 2 F540	<u>Quercus</u> sp
---	charcoal with Per 1 metal-work	<u>Quercus</u> sp
F390	burnt timber on Per 2 floor	<u>Quercus</u> sp
F391	burnt timber on Per 2 floor	<u>Quercus</u> sp
F392	burnt timber on Per 2 floor	<u>Quercus</u> sp
F393	burnt timber on Per 2 floor	<u>Quercus</u> sp (plus some bast in F392/3)
F394	burnt timber on Per 2 floor	Pinaceae (probably <u>Larix decidua</u> )
F396	burnt timber on Per 2 floor	<u>Quercus</u> sp & <u>Fraxinus excelsior</u>
F397	burnt timber on Per 2 floor	unidentified
F398	burnt ?shelf on Per 2 floor	<u>Fraxinus excelsior</u>
F403	burnt timber on Per 2 floor	<u>Fraxinus excelsior</u>
F431	burnt timber on Per 2 floor	<u>Quercus</u> sp
F432	burnt timber on Per 2 floor	<u>Quercus</u> sp

## Site K

334	Per 2 destruction	<u>Quercus</u> sp
-----	-------------------	-------------------

## Site L

134	Lime kilns F88	<u>Quercus</u> sp & Pomoideae
-----	----------------	-------------------------------



207 Lime kilns F119 Quercus sp

Site R

191 Per 2a charcoal Quercus sp

BALKERNE LANE

Site E

986 Per 1b charcoal Quercus sp  
 1120 Per 1b L337+ charcoal sample unidentified  
 1145 Per 1b hearth F322 Quercus sp  
 1257 Per 1b charcoal patch Quercus sp  
 1261 Per 1b charcoal patch Quercus sp  
 1264 Per 1b charcoal patch Fagus sylvatica and another -  
 possibly Corylus avellana/Alnus  
glutinosa  
 1322 Per 1b charcoal patch Quercus sp  
 1333 Per 1b dump of charcoal Quercus sp

Site G

164 ground-plate F35 Salix sp/Populus sp and probably  
 another - probably Viburnum sp,  
 possibly Viburnum opulus

Site T

403 Per 1b charcoal layer L50 Quercus sp

Site V

L93 charcoal & daub on Per 2 floor mainly Quercus sp with some Fraxinus  
excelsior

Glossary

Quercus sp

oak

Pomoideae

could be pear/apple/rowan or various other rosaceous  
 fruiting trees

Fraxinus excelsior

ash

Corylus avellana/

hazel or alder

Alnus glutinosa

Buxus sempervirens

box

Rhamnus cathartica

purging buckthorn (very 'mystical', associated with the  
 underworld and was often placed in door thresholds,  
 still is in Holland)

Larix decidua

European larch

Viburnum opulus

guelder rose

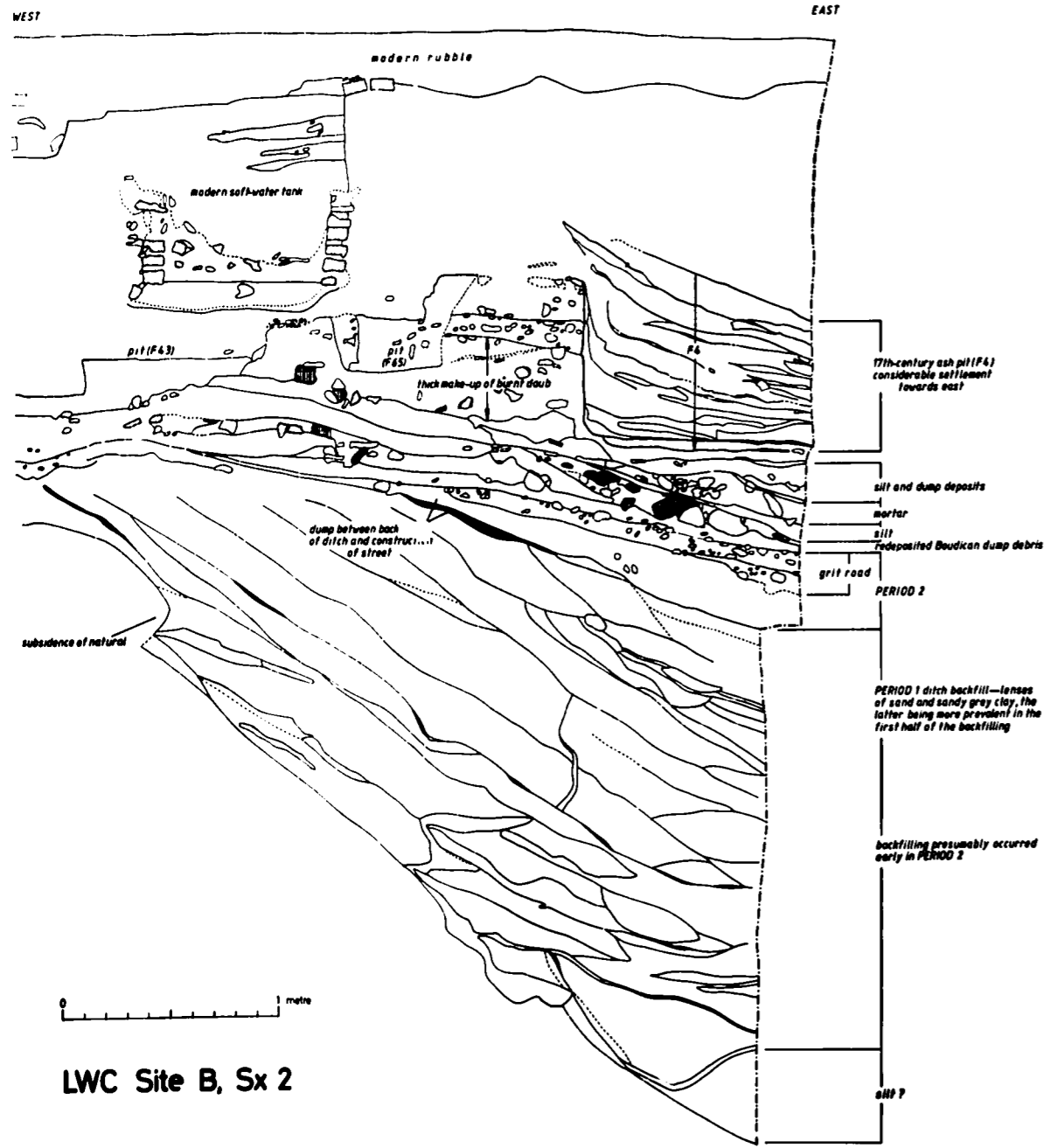
Fagus sylvatica

common beech

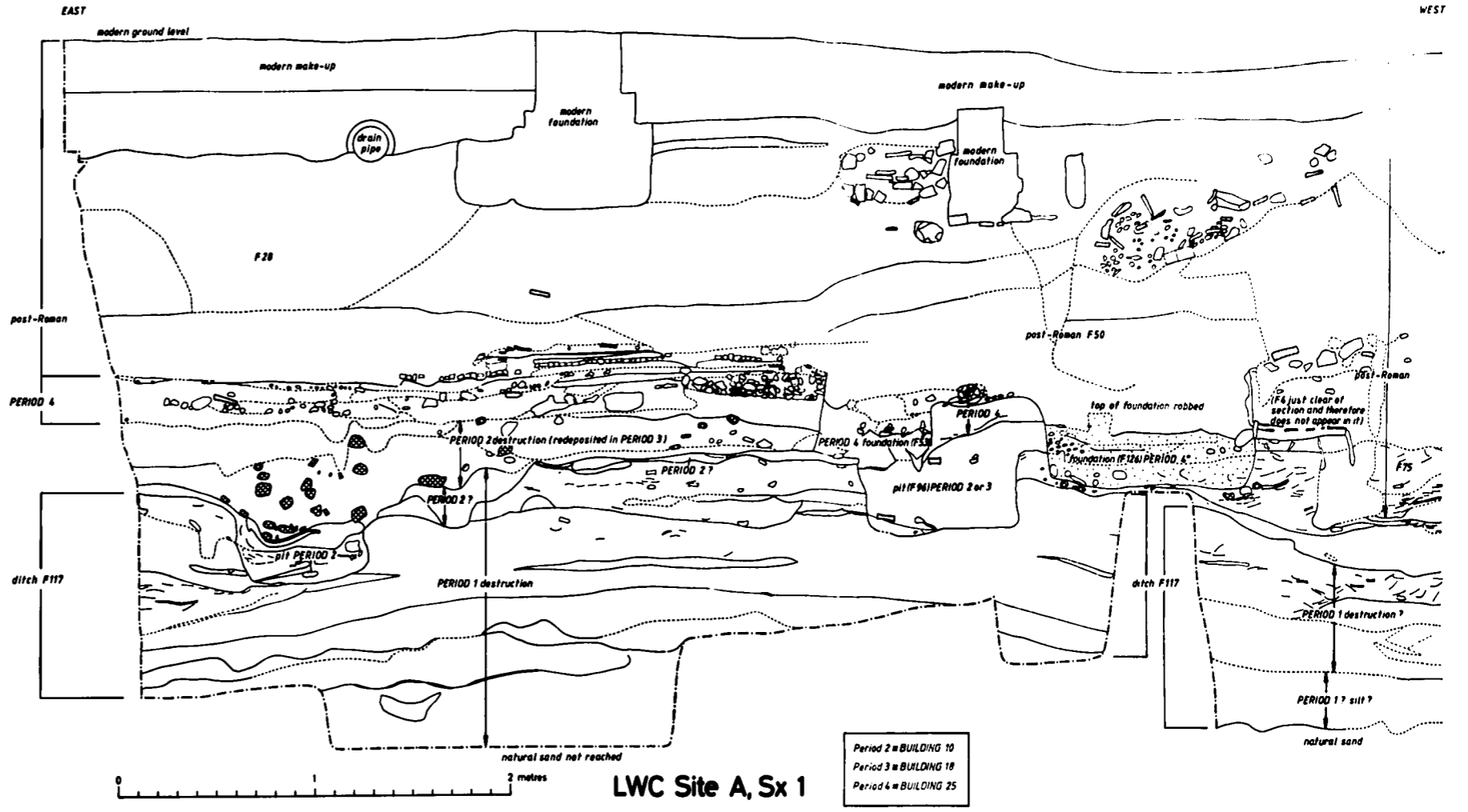
# Sxs 1-3

**KEY FOR SECTIONS**

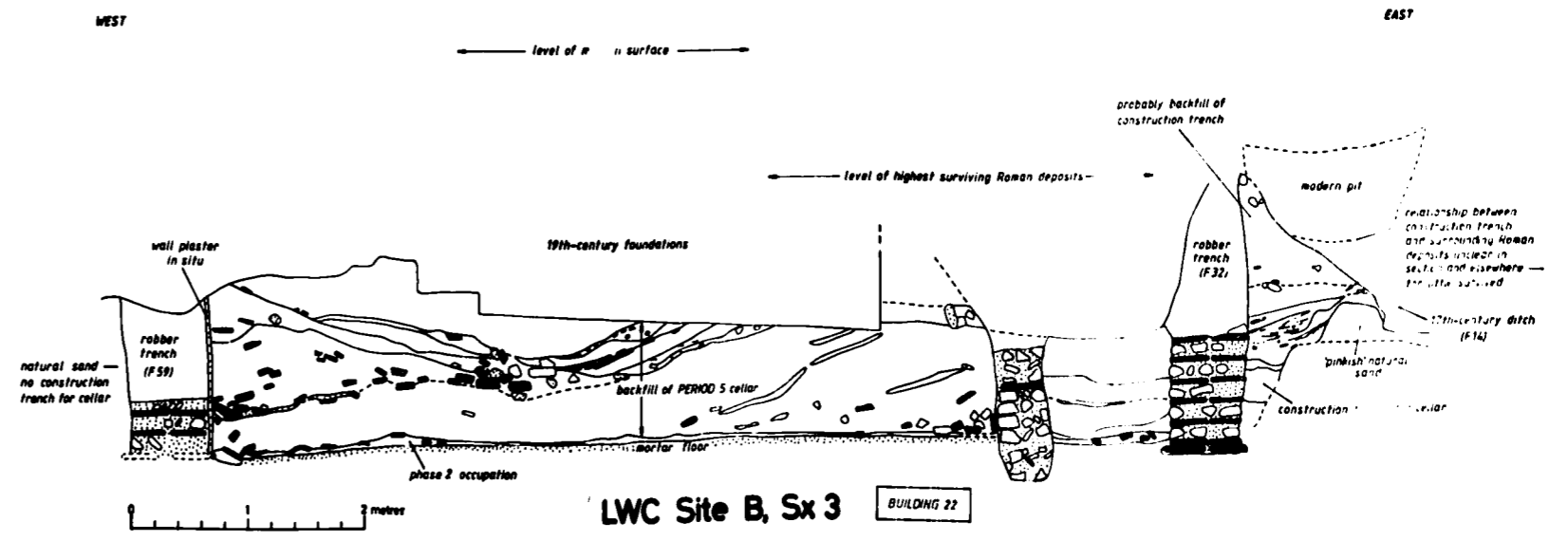
	gravel
	sandy gravel
	occupation level
	scorched surface
	mortar
	opus reticulatum
	Roman tile
	post-medieval and modern brick and tile
	burnt daub



LWC Site B, Sx 2



LWC Site A, Sx 1



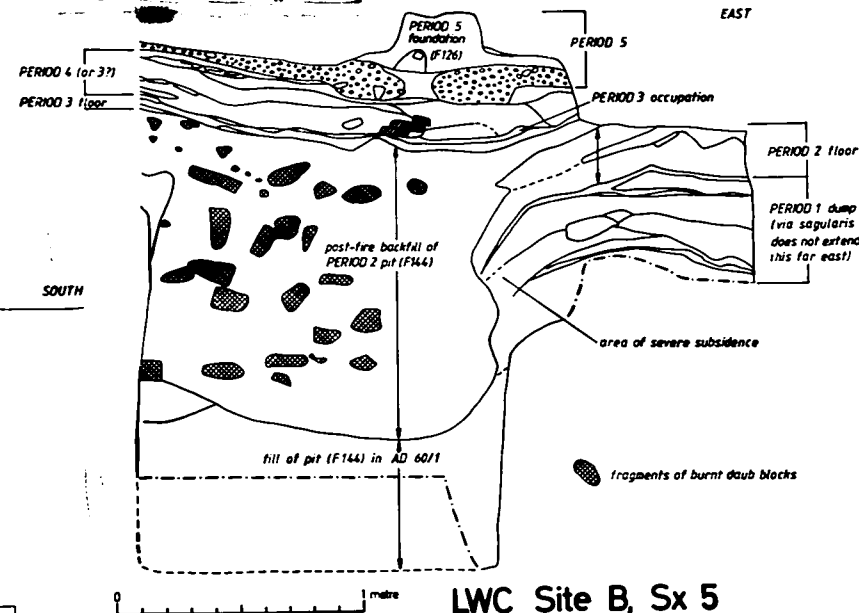
LWC Site B, Sx 3

BUILDING 22

# Sxs 4-11

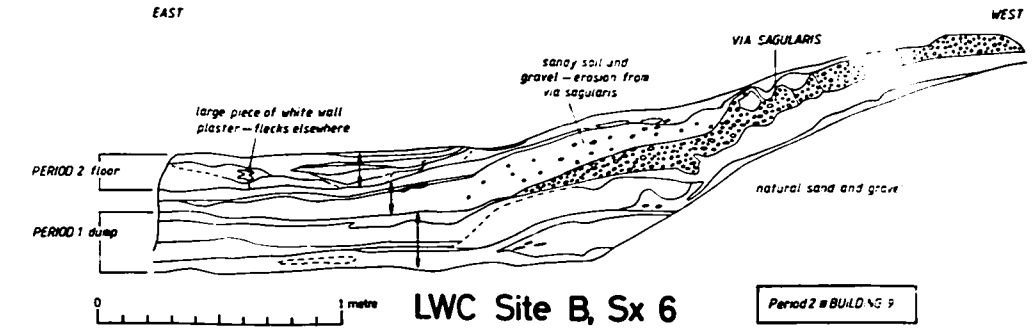
**KEY FOR SECTIONS**

- gravel
- sandy gravel
- occupation level
- scorched surface
- mortar
- oysters
- Roman tile
- post-medieval and modern brick and tile



LWC Site B, Sx 5

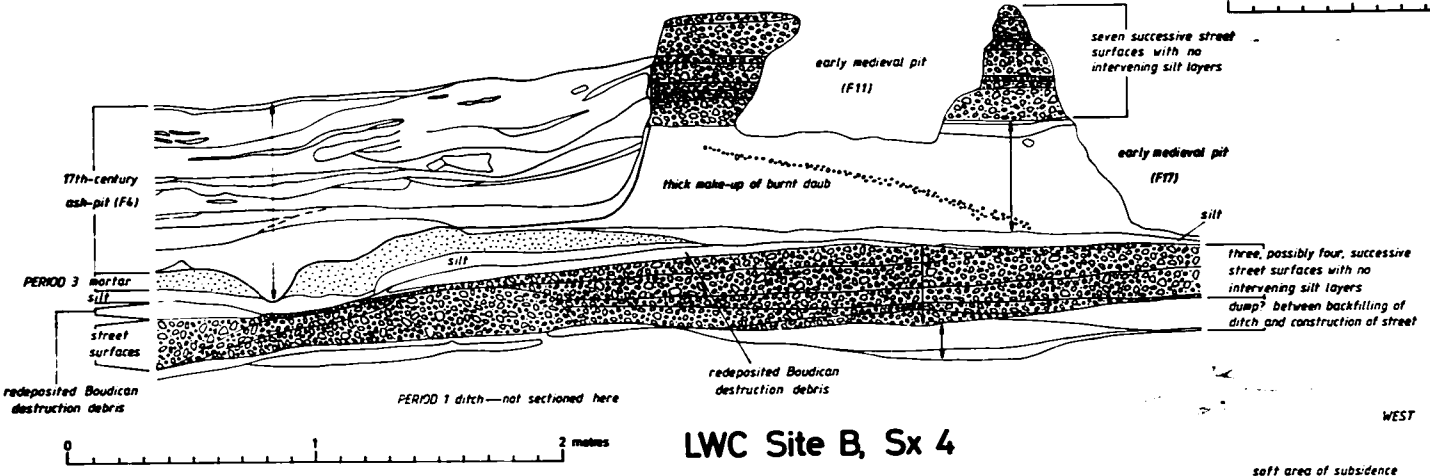
Period 2 ■ BUILDING 9  
 Period 3 ■ BUILDING 17  
 Period 4 ■ PITS AND DUMP  
 Period 5 ■ BUILDING 23



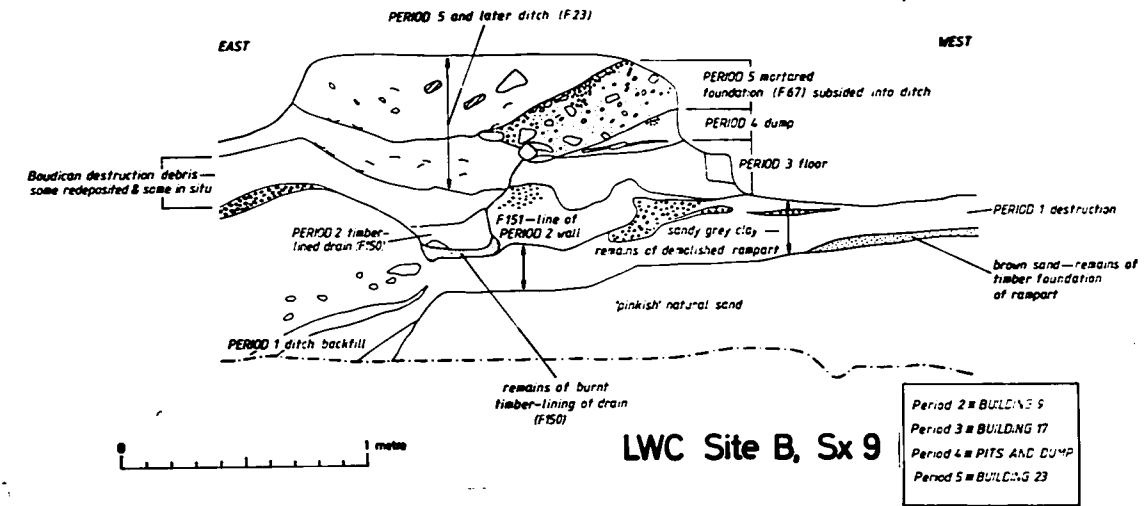
LWC Site B, Sx 6

Period 2 ■ BUILDING 9

black almost homogenous topsoil — similar to fill of early medieval pits

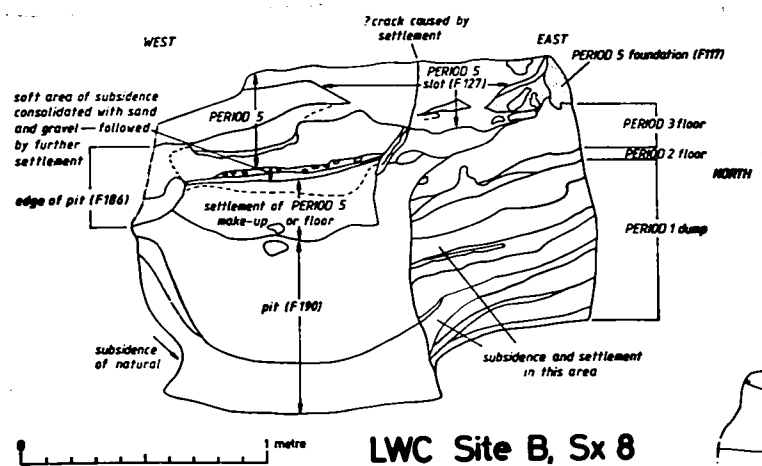


LWC Site B, Sx 4



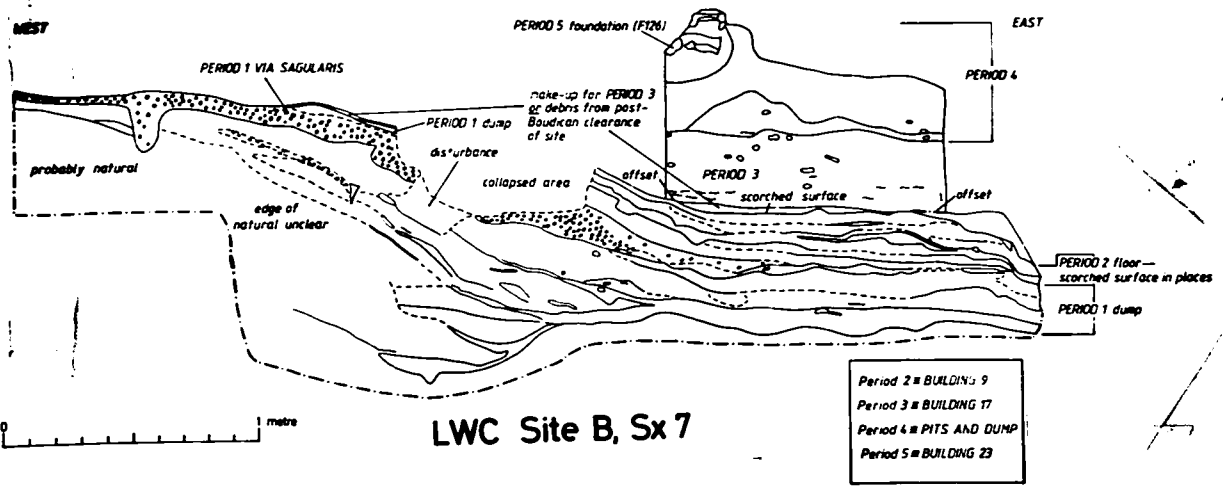
LWC Site B, Sx 9

Period 2 ■ BUILDING 9  
 Period 3 ■ BUILDING 17  
 Period 4 ■ PITS AND DUMP  
 Period 5 ■ BUILDING 23



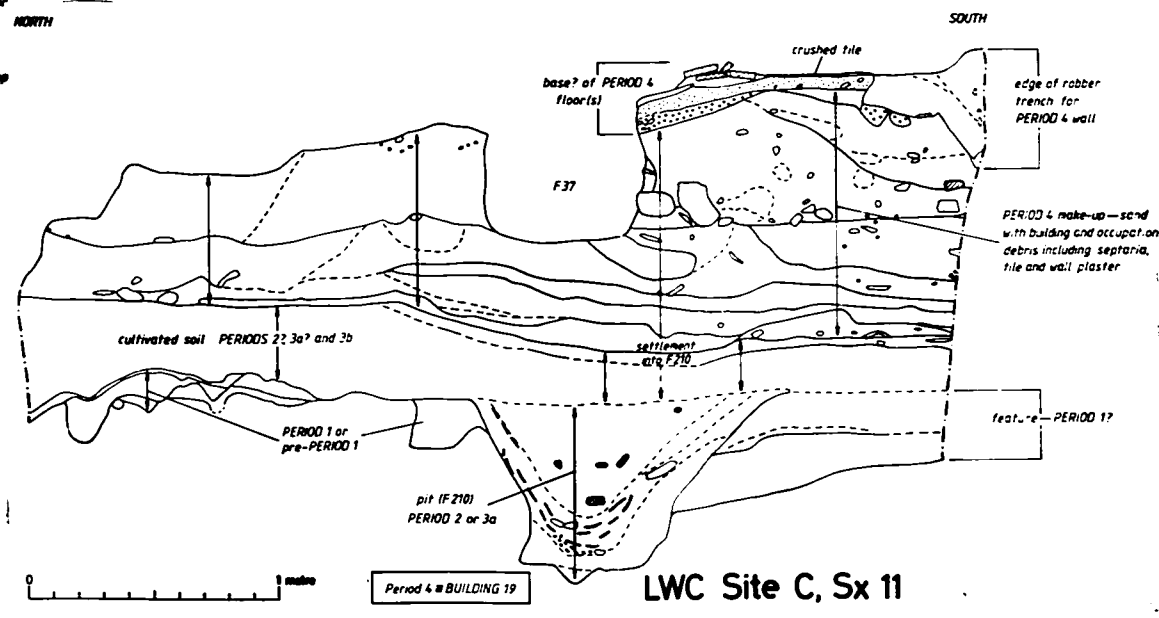
LWC Site B, Sx 8

Period 2 ■ BUILDING 9  
 Period 3 ■ BUILDING 17  
 Period 5 ■ BUILDING 23



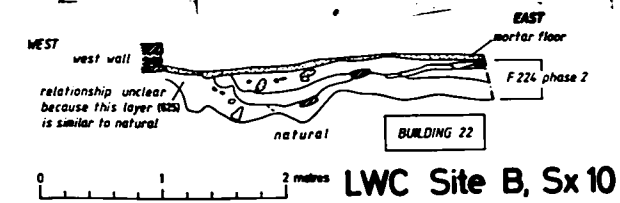
LWC Site B, Sx 7

Period 2 ■ BUILDING 9  
 Period 3 ■ BUILDING 17  
 Period 4 ■ PITS AND DUMP  
 Period 5 ■ BUILDING 23



LWC Site C, Sx 11

Period 4 ■ BUILDING 19



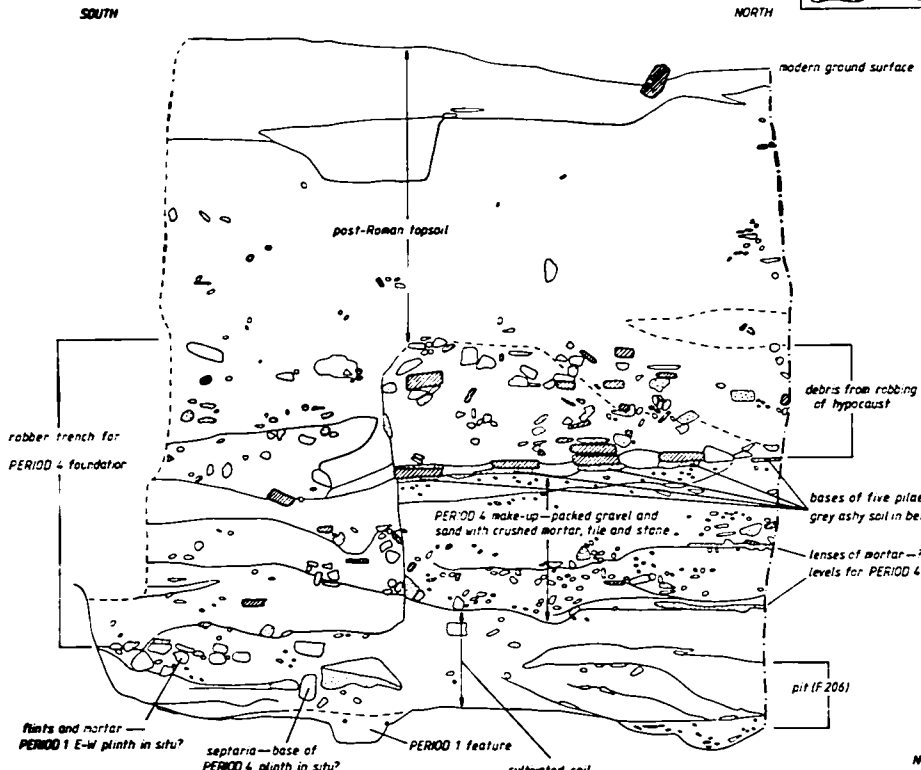
LWC Site B, Sx 10

BUILDING 22

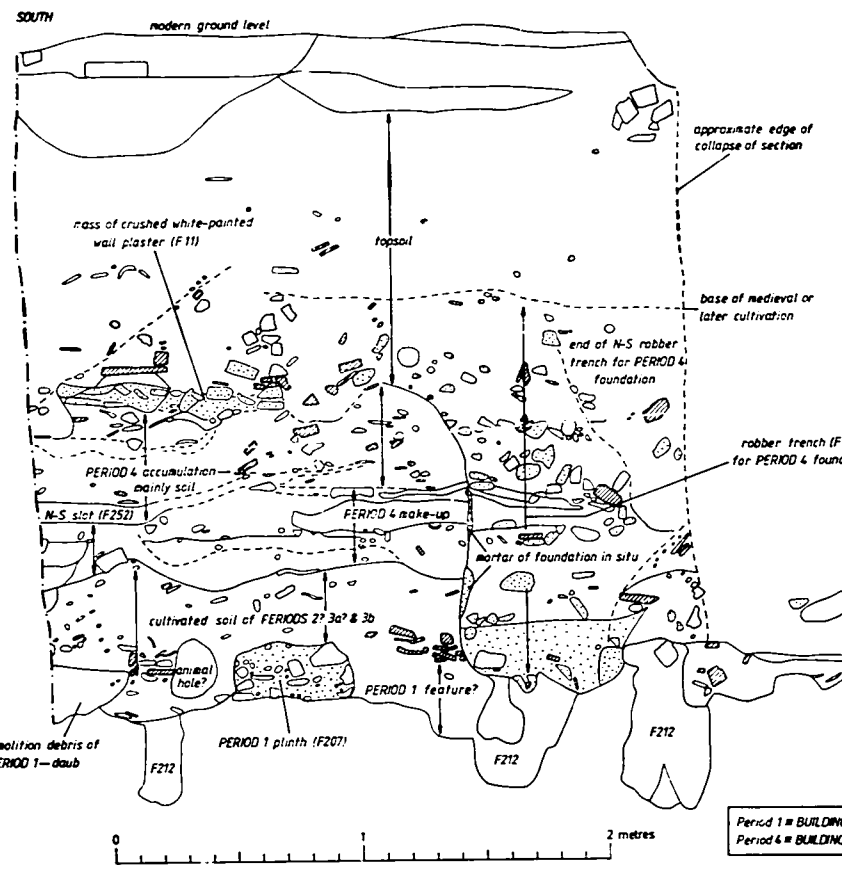
# Sxs 12-19

**KEY FOR SECTIONS**

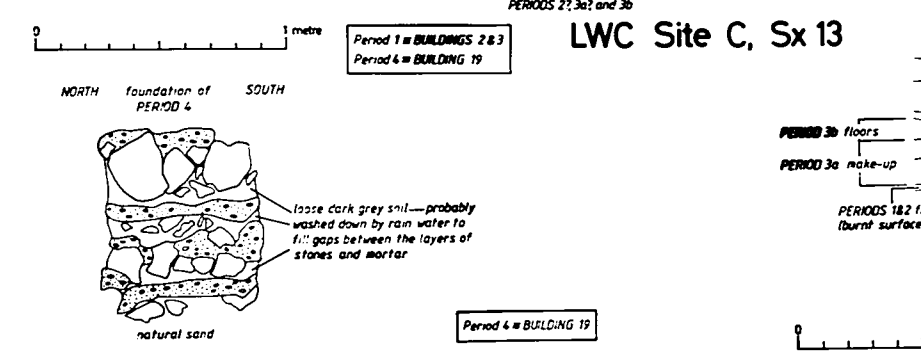
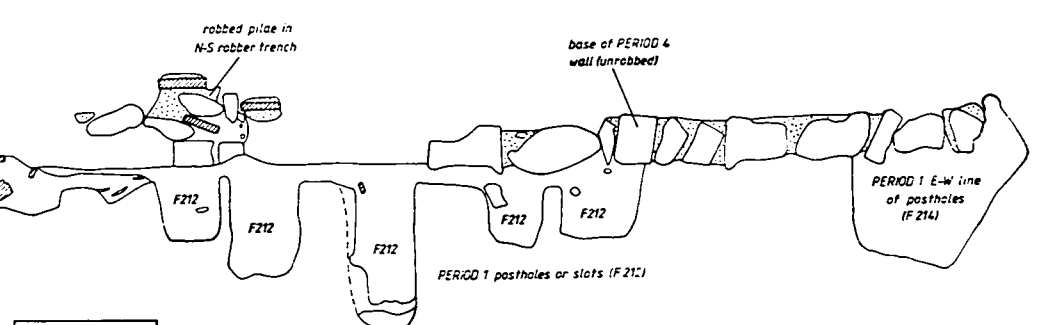
- gravel
- sandy gravel
- occupation level
- starched surface
- mortar
- cysters
- Roman tile
- post-medieval modern brick and tile



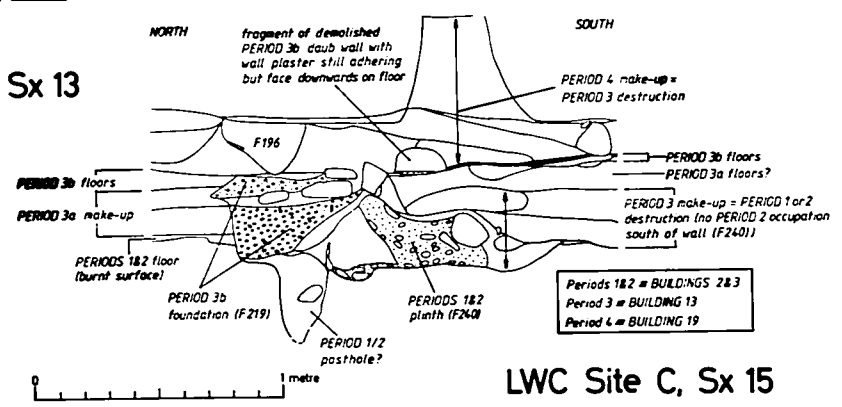
LWC Site C, Sx 12



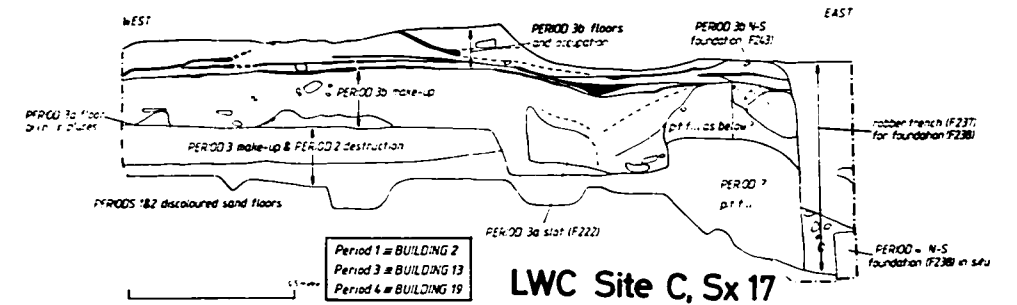
LWC Site C, Sx 13



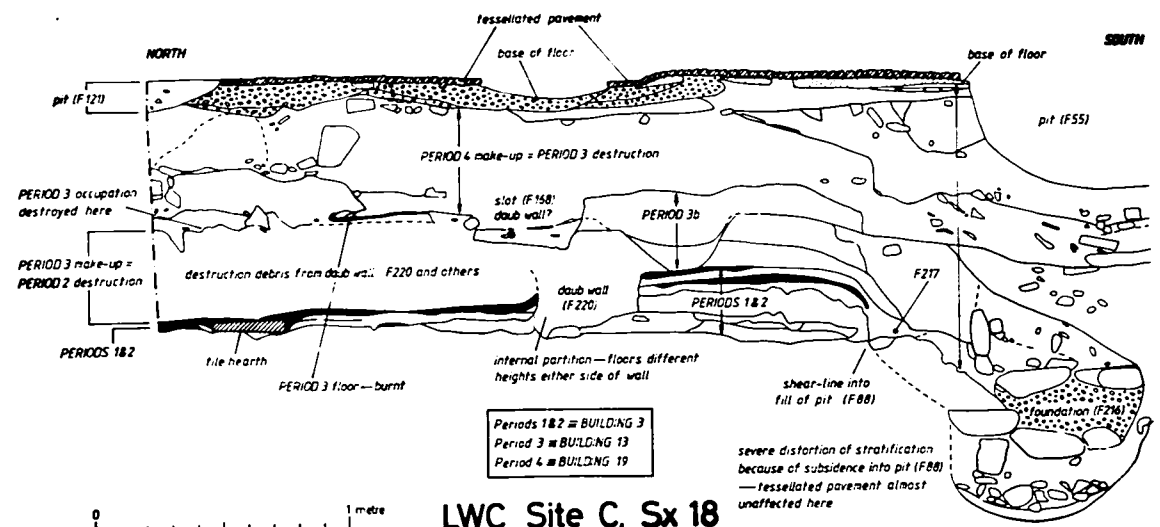
LWC Site C, Sx 14



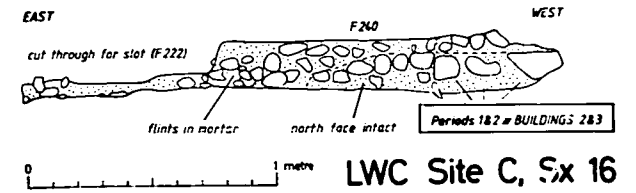
LWC Site C, Sx 15



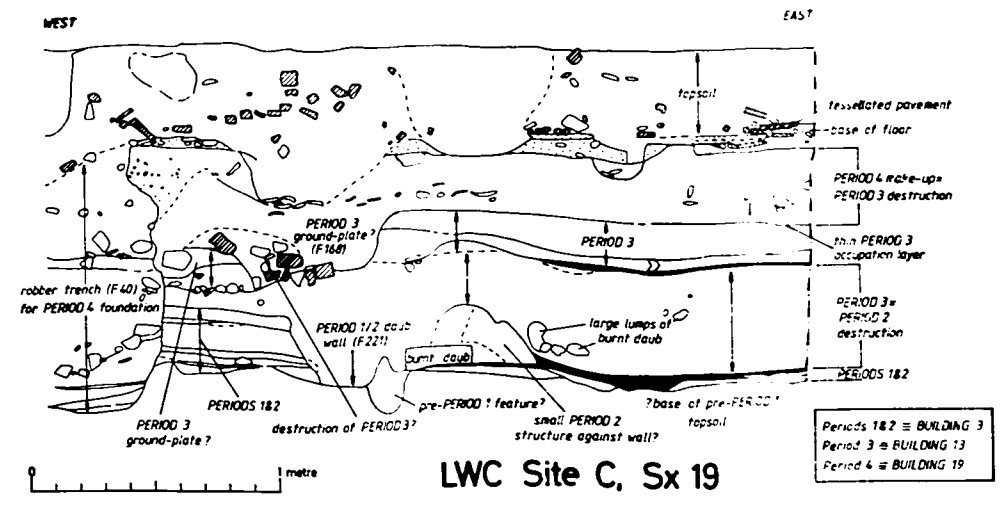
LWC Site C, Sx 17



LWC Site C, Sx 18



LWC Site C, Sx 19



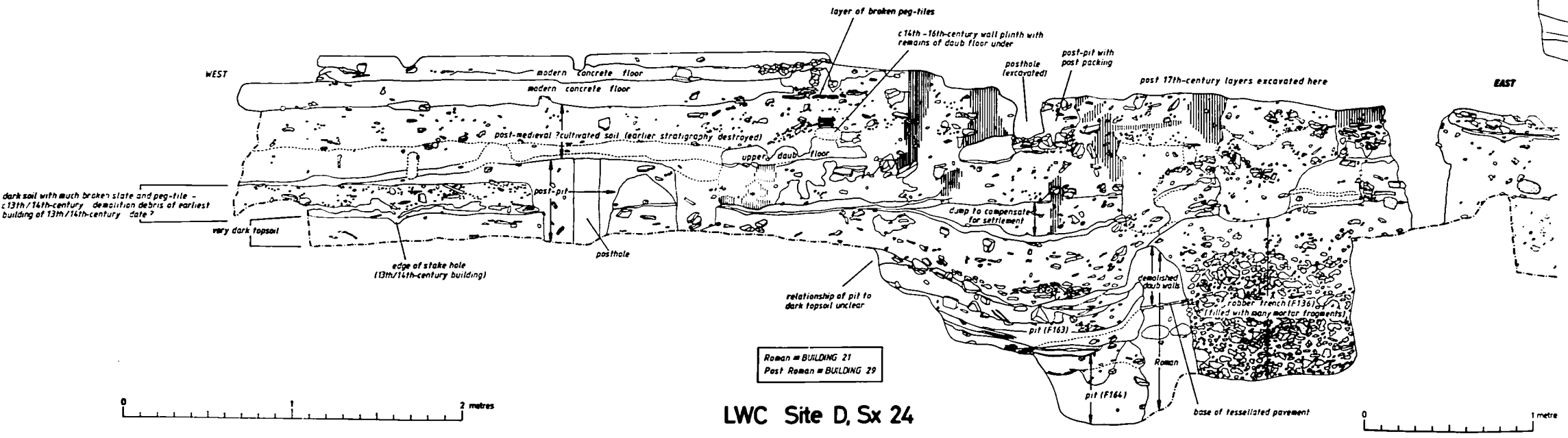
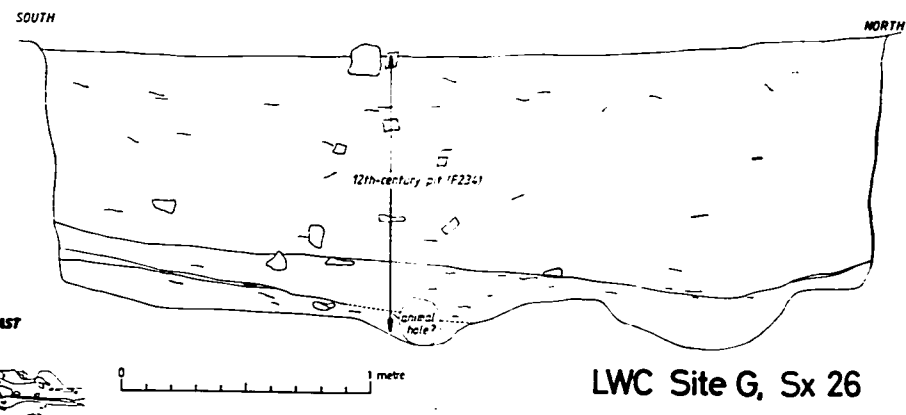
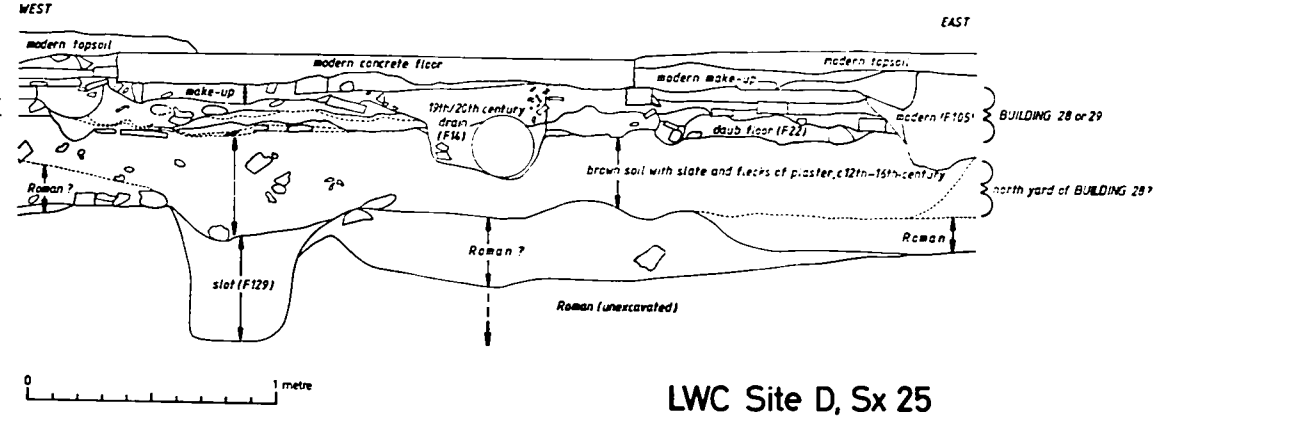
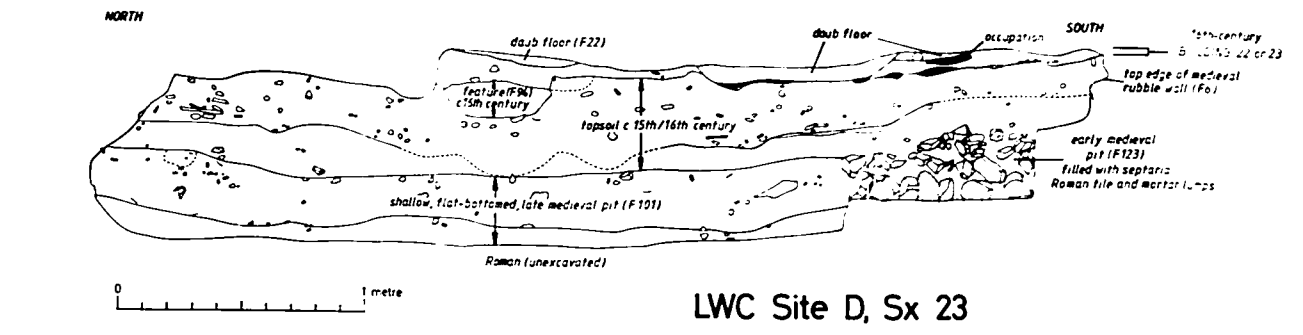
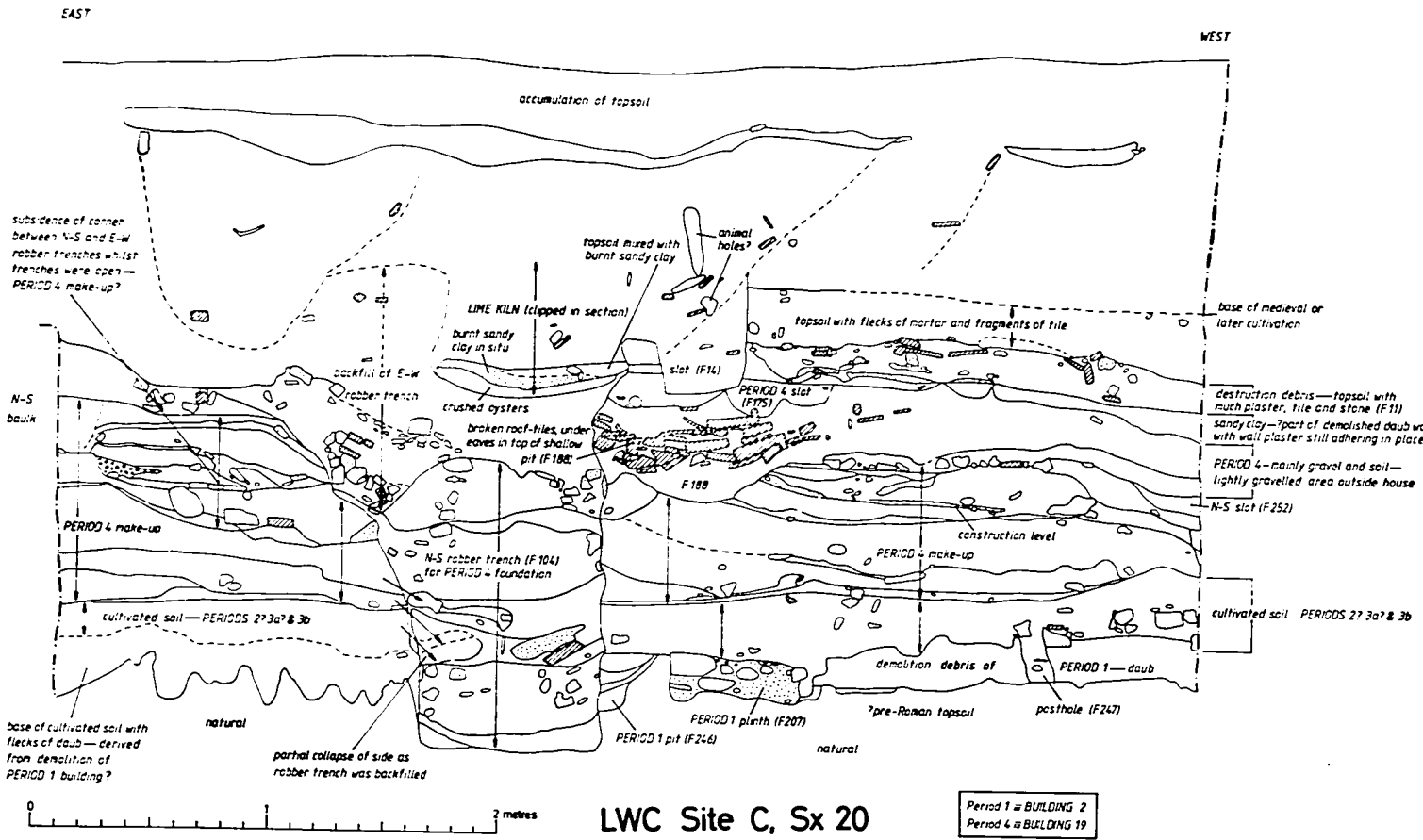
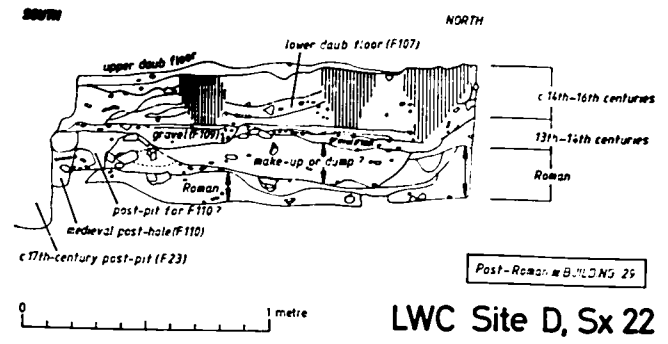
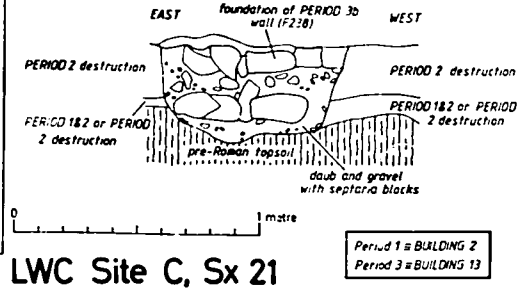
LWC Site C, Sx 19



# Sxs 20-26

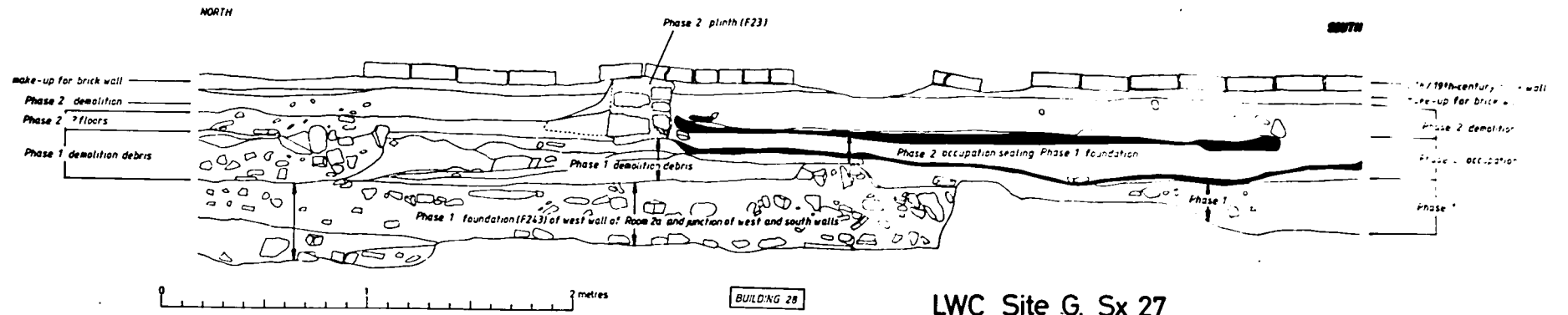
**KEY FOR SECTIONS**

- soil
- sandy gravel
- occupation level
- scorched surface
- moat
- cysters
- Roman tile
- post-medieval
- modern brick and tile

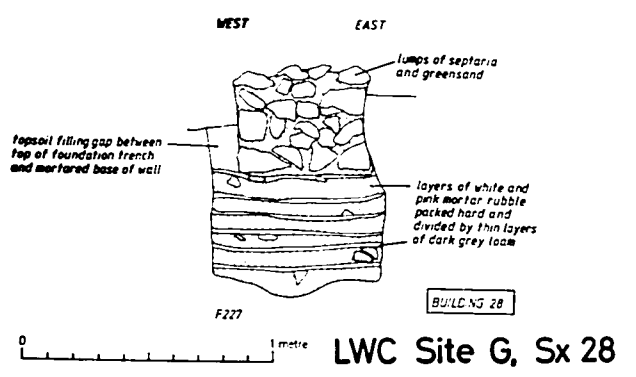


# Sxs 27-33

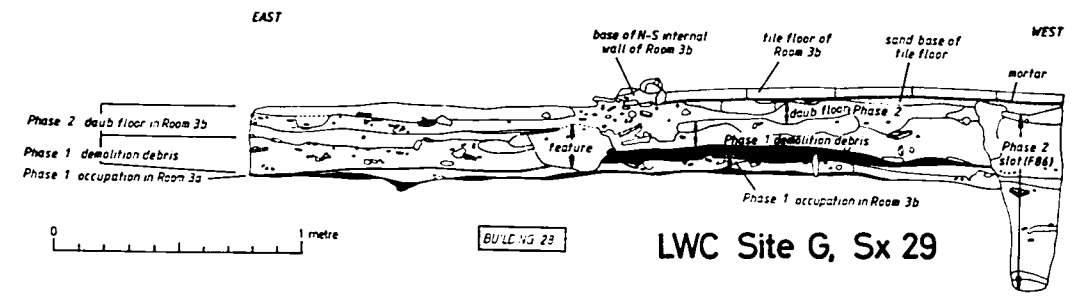
KEY FOR SECTIONS	
	gravel
	sandy gravel
	occupation level
	scorched surface
	mortar
	cinders
	Roman tile
	post-medieval/modern brick and tile



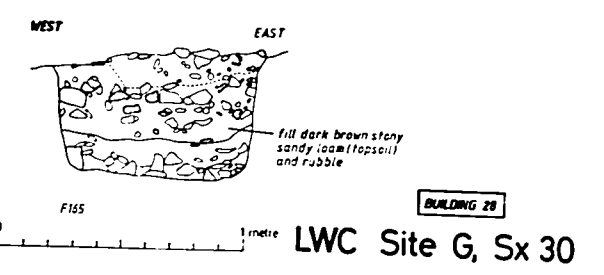
LWC Site G, Sx 27



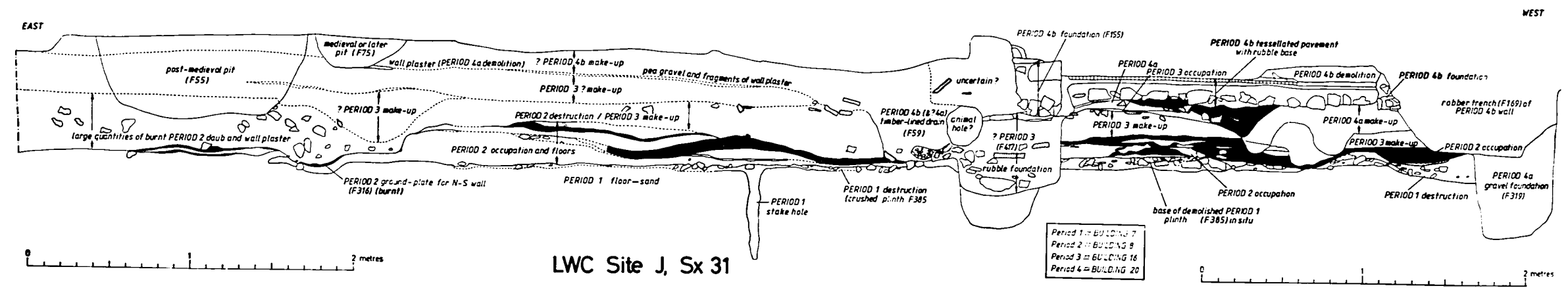
LWC Site G, Sx 28



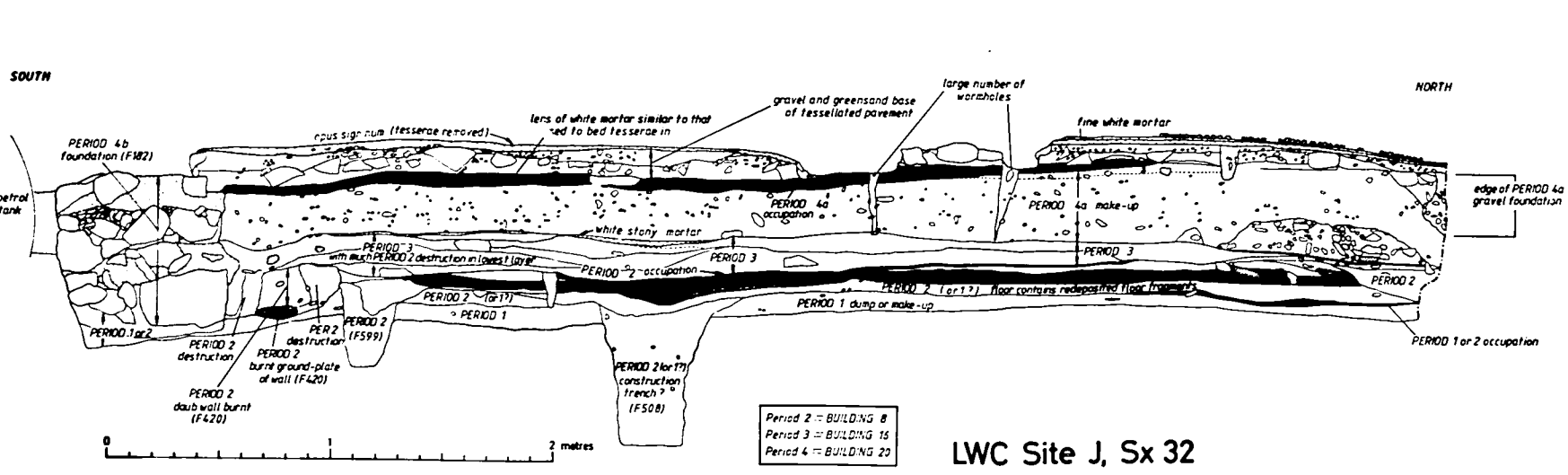
LWC Site G, Sx 29



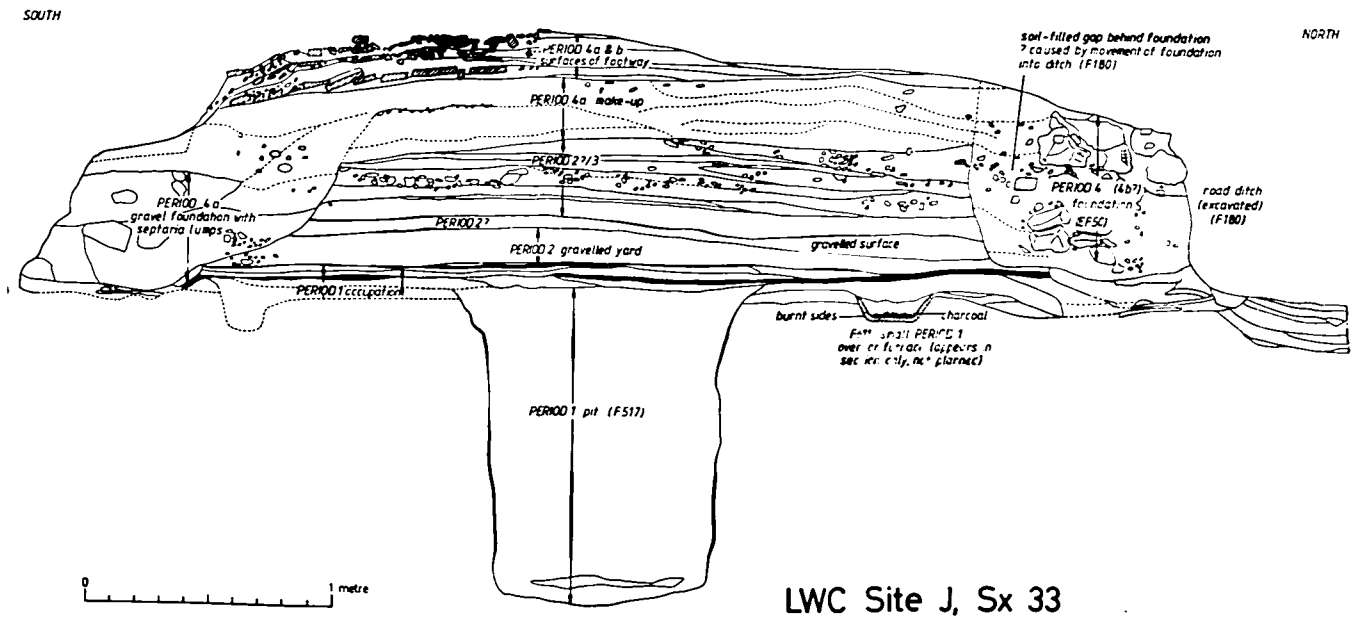
LWC Site G, Sx 30



LWC Site J, Sx 31



LWC Site J, Sx 32



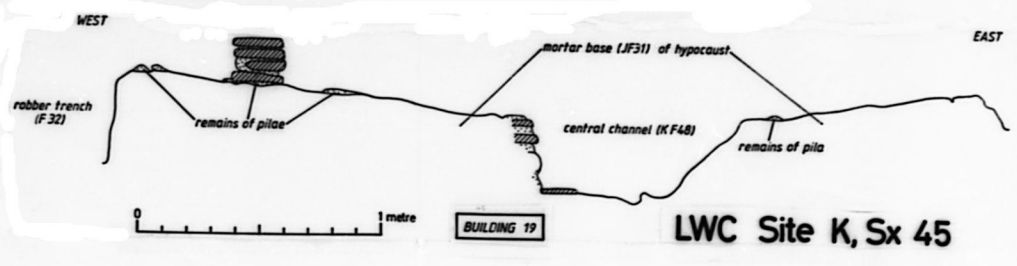
LWC Site J, Sx 33



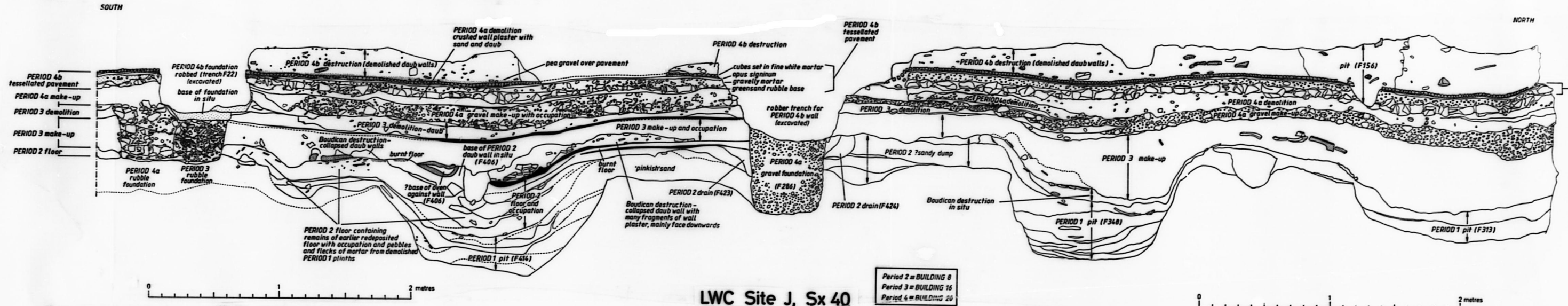
# Sxs 40-45

**KEY FOR SECTIONS**

- gravel
- sandy gravel
- occupation level
- scorched surface
- mortar
- oysters
- Roman tile
- post-medieval and modern brick and tile

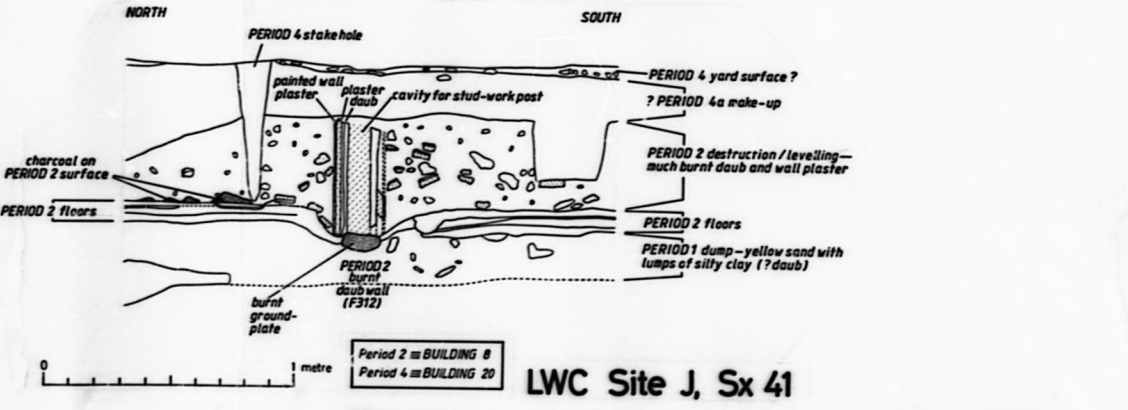


LWC Site K, Sx 45

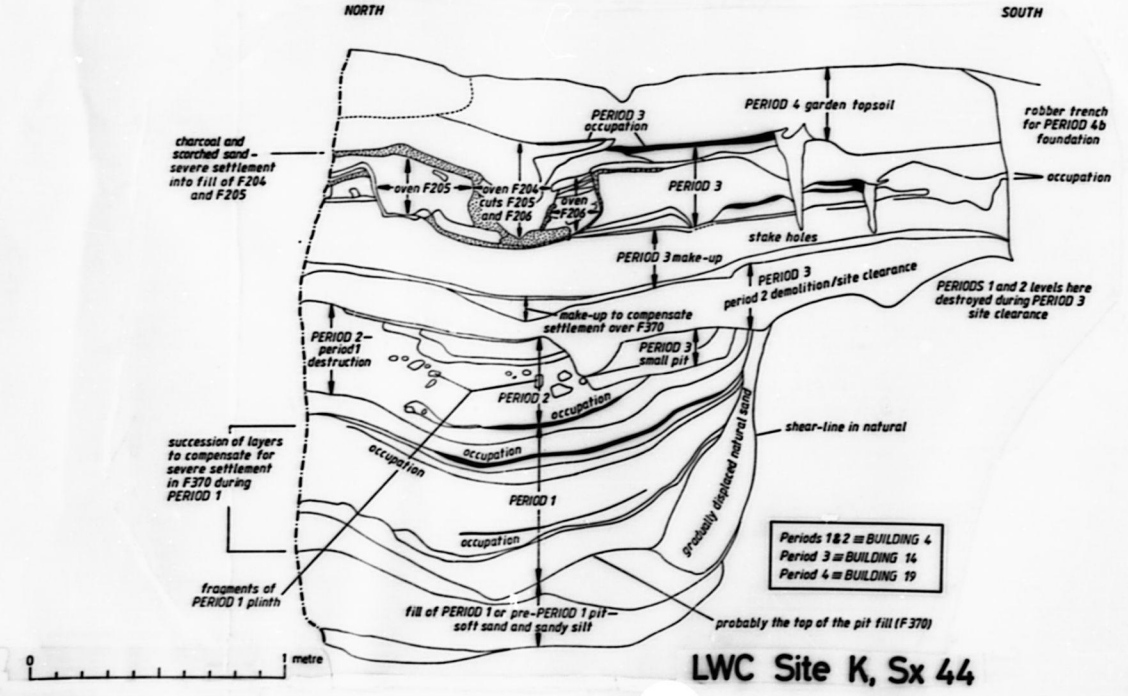


LWC Site J, Sx 40

Period 2 = BUILDING 8  
Period 3 = BUILDING 16  
Period 4 = BUILDING 20

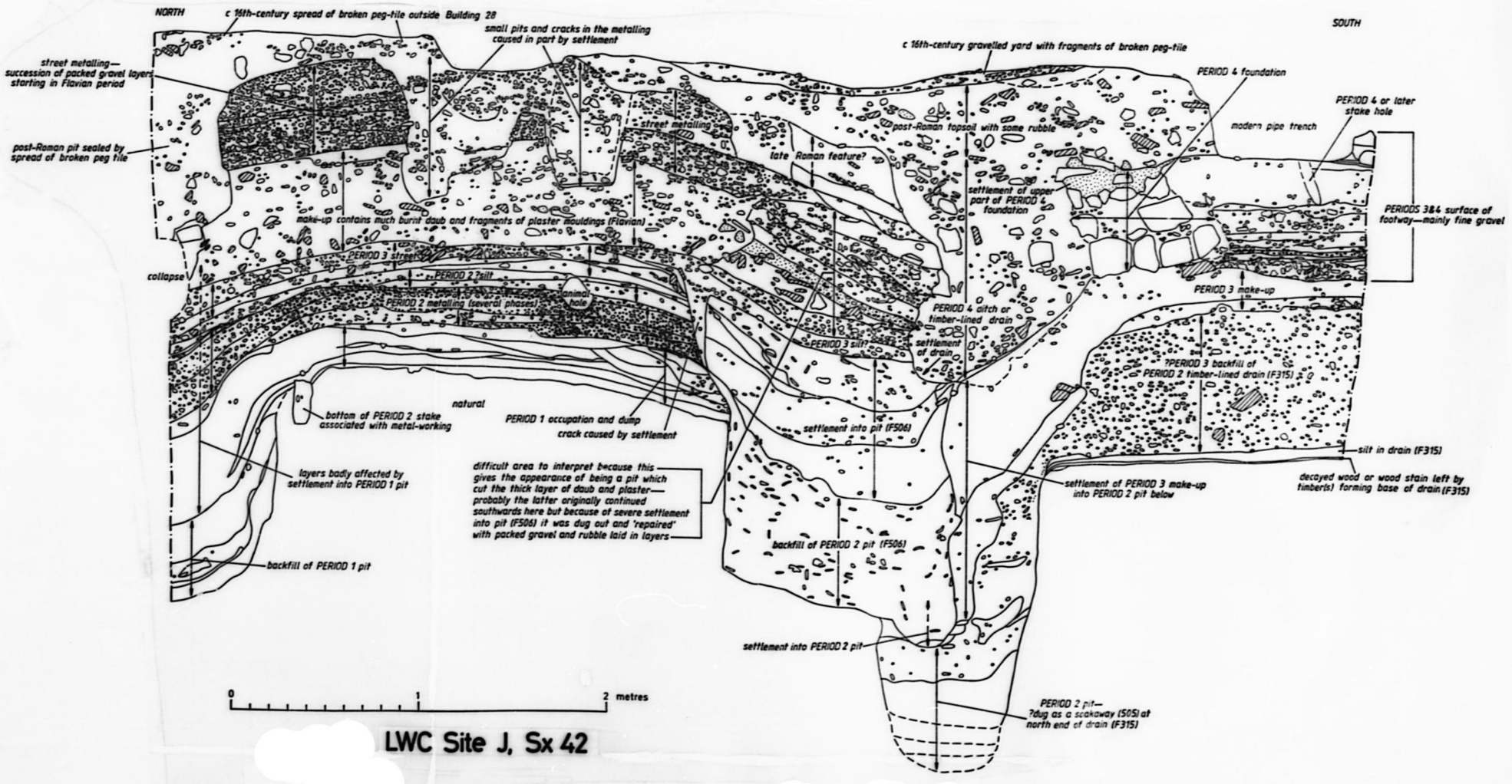


LWC Site J, Sx 41



LWC Site K, Sx 44

Periods 1 & 2 = BUILDING 4  
Period 3 = BUILDING 14  
Period 4 = BUILDING 19



LWC Site J, Sx 42

difficult area to interpret because this gives the appearance of being a pit which cut the thick layer of daub and plaster—probably the latter originally continued southwards here but because of severe settlement into pit (F506) it was dug out and 'repaired' with packed gravel and rubble laid in layers

PERIOD 2 pit—  
70g as a soakaway (S05) at  
north end of drain (F315)

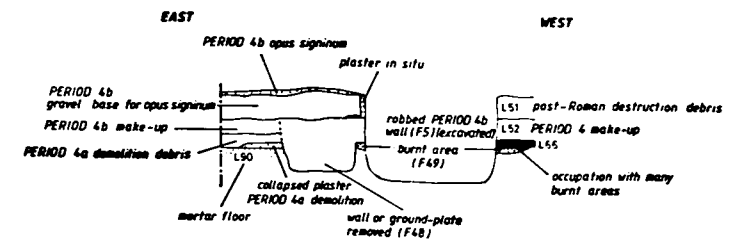
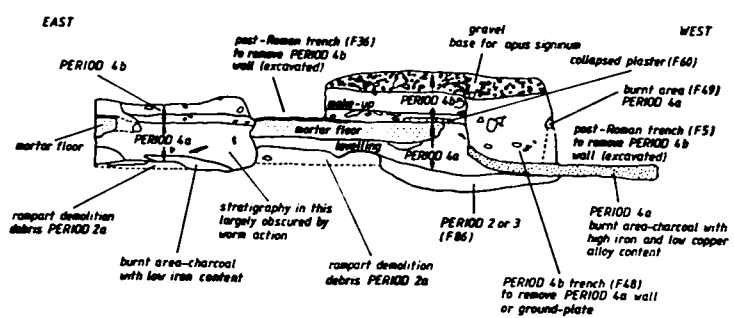




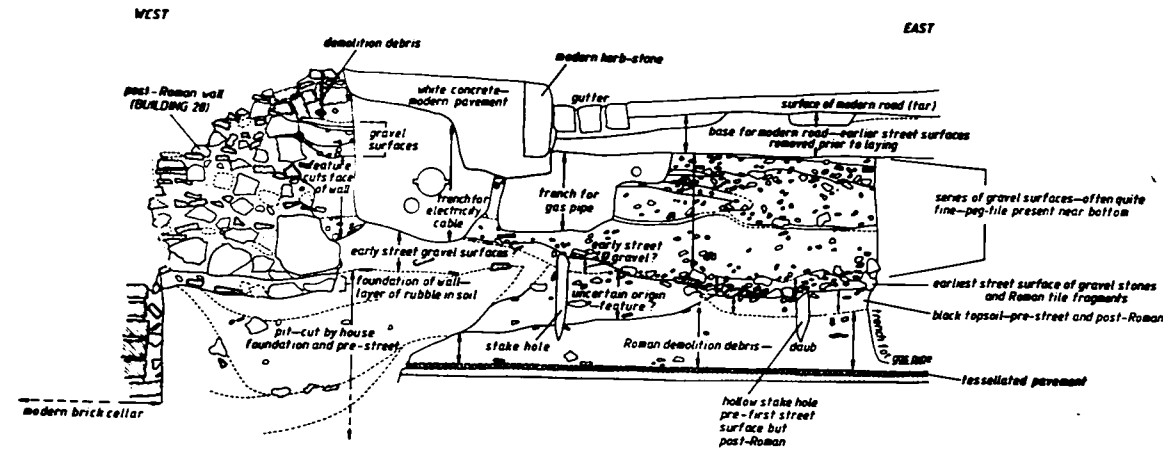
# Sxs 53-64

**KEY FOR SECTIONS**

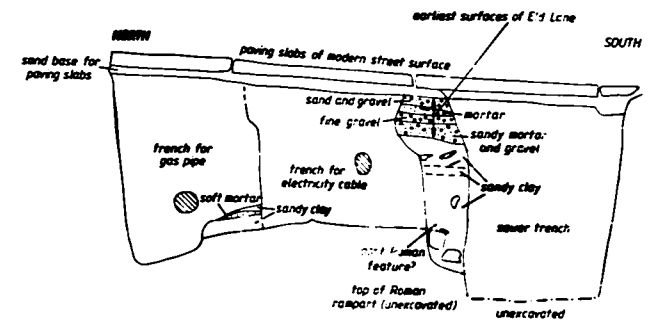
- gravel
- sandy gravel
- occupation level
- scorched surface
- mortar
- oysters
- Roman tile
- post-medieval and modern brick and tile



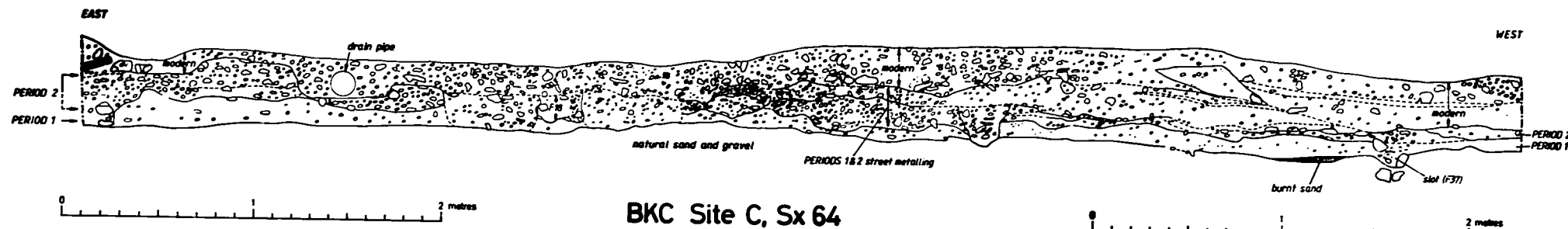
LWC Site R, Sx 59



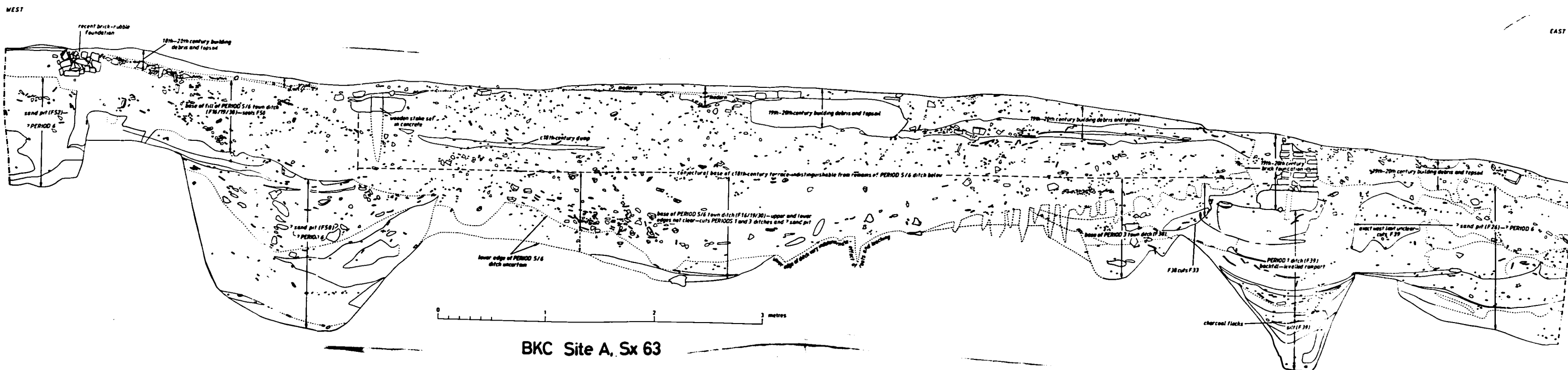
LWC Across Lion walk north end, Sx 60



LWC Site M, Sx 53



BKC Site C, Sx 64



BKC Site A, Sx 63



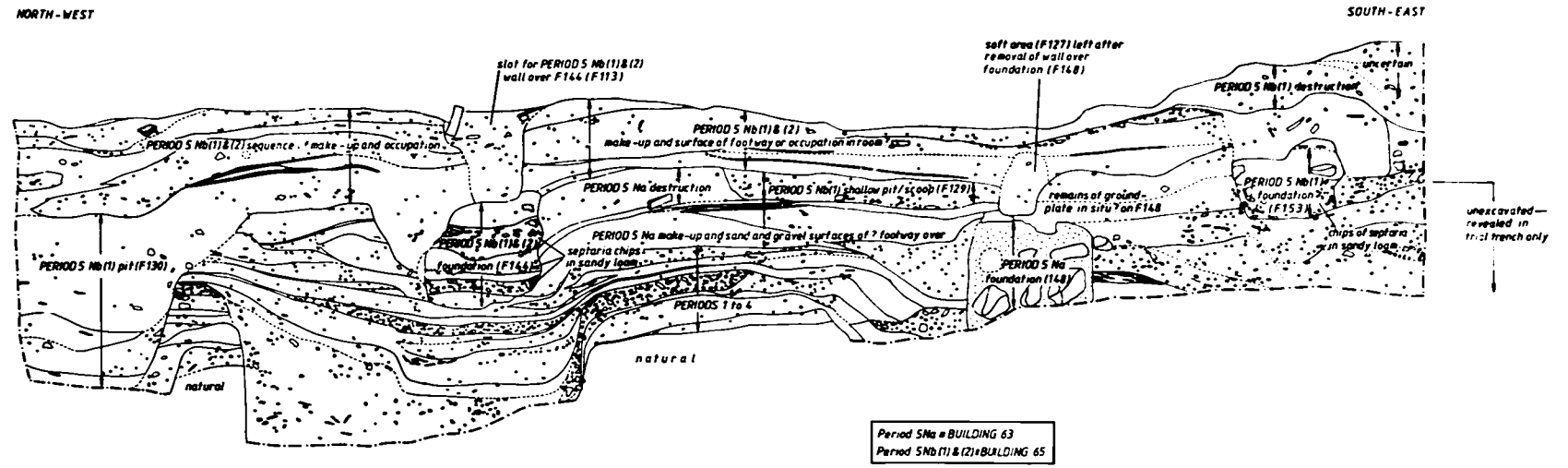




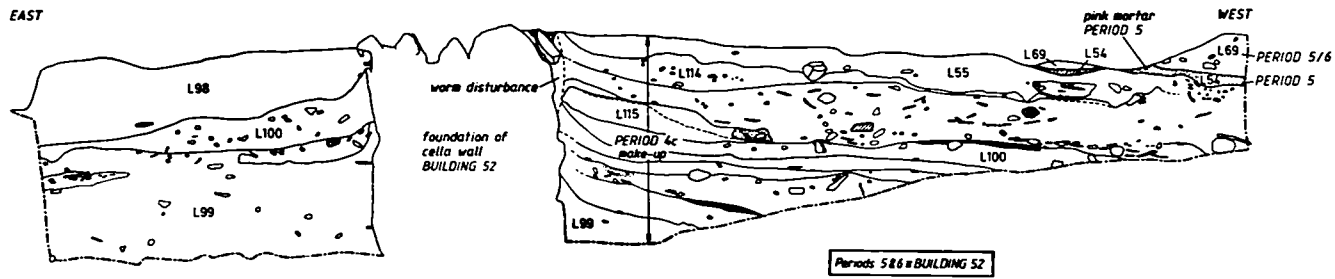
# Sxs 77-83

**KEY FOR SECTIONS**

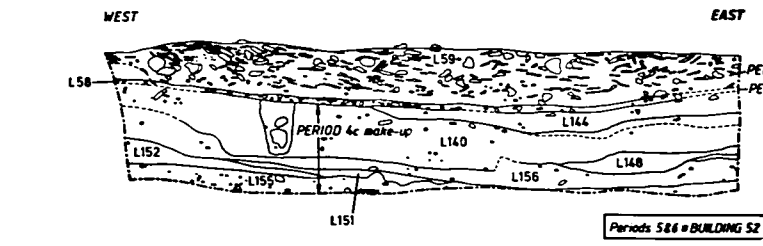
	gravel
	sandy gravel
	occupation level
	scorched surface
	mortar
	ostraea
	Roman tile
	post-medieval and modern brick and tile



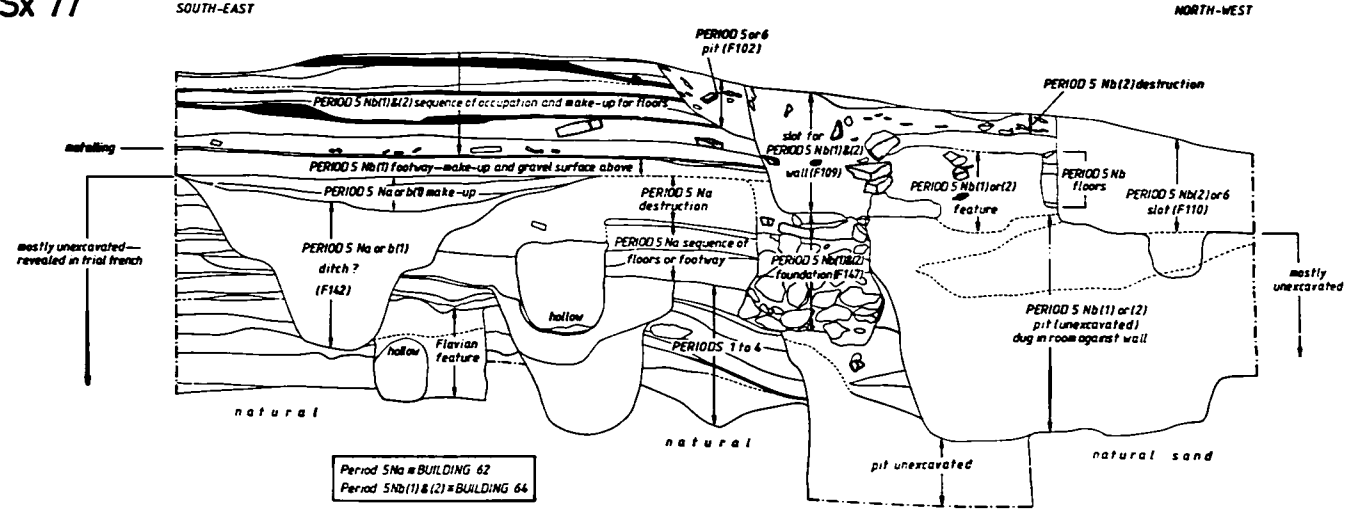
**BKC Site N, Sx 79**



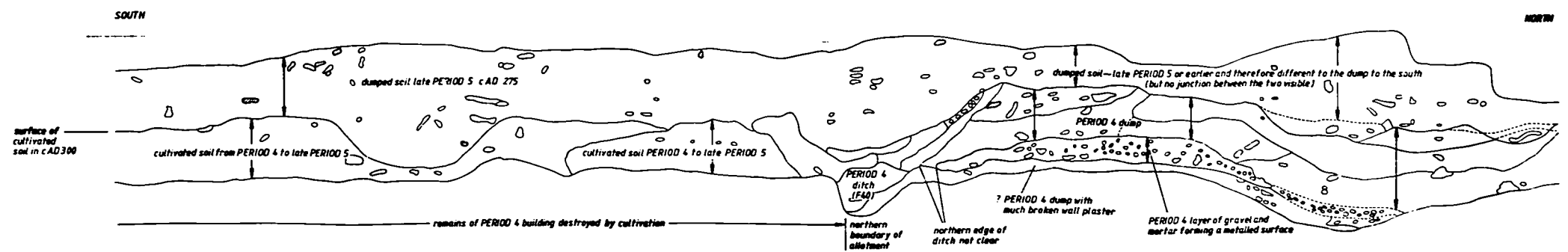
**BKC Site K, Sx 77**



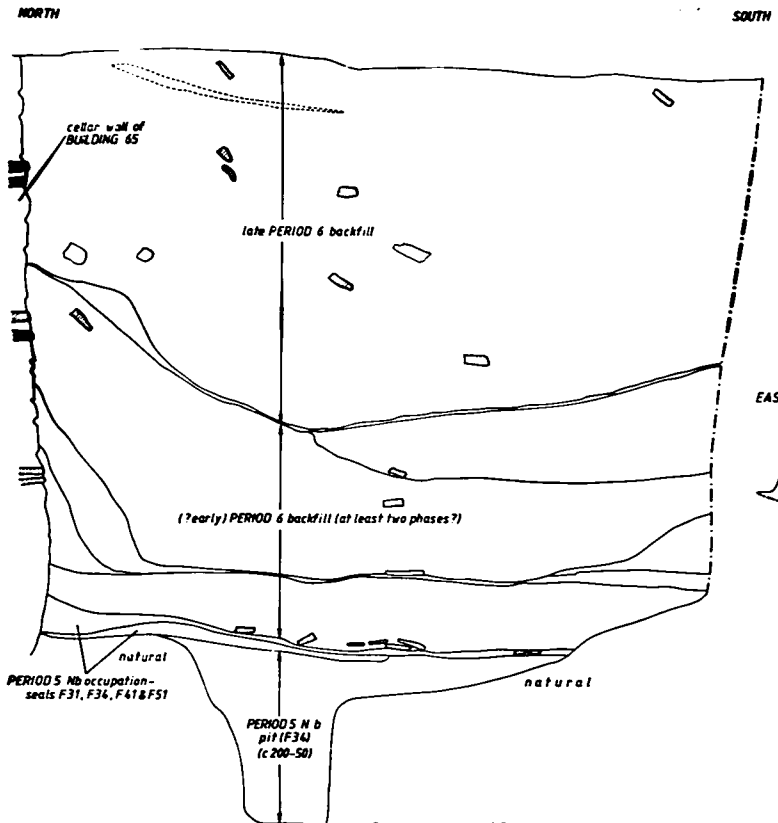
**BKC Site K, Sx 78**



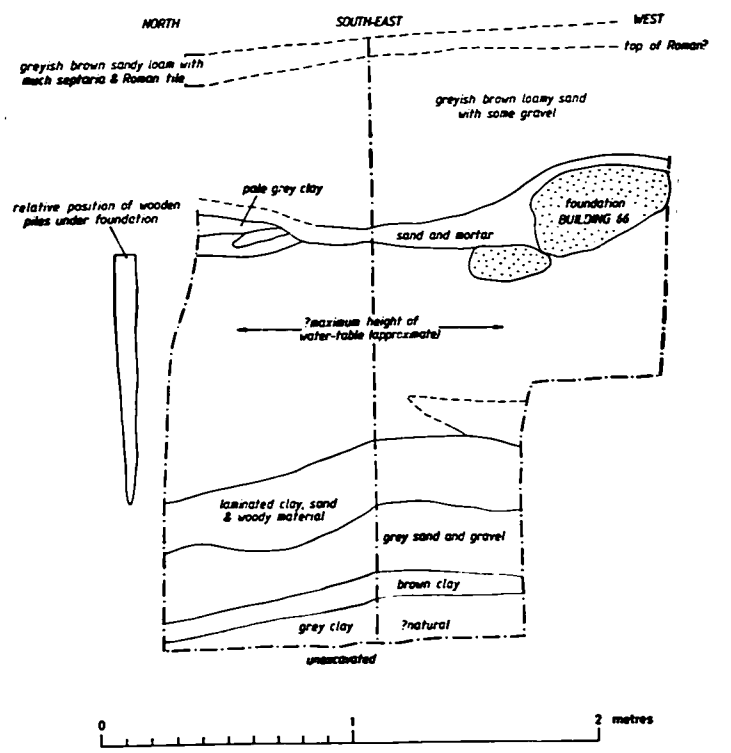
**BKC Site N, Sx 80**



**BKC Site V, Sx 83**



**BKC Site N, Sx 81**

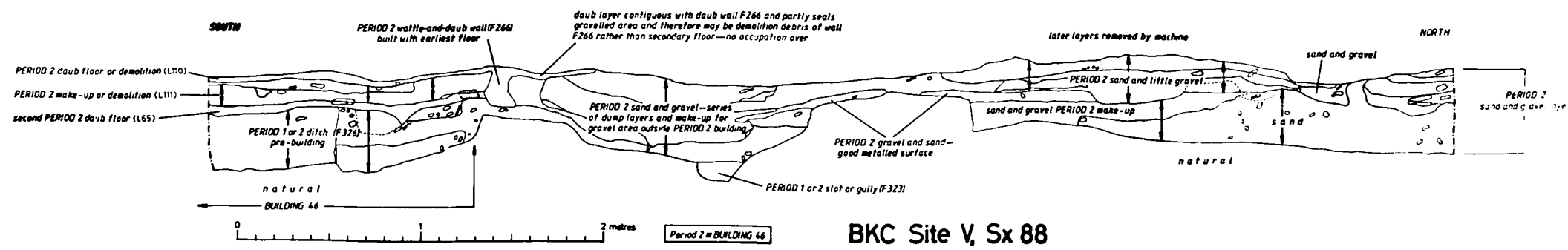
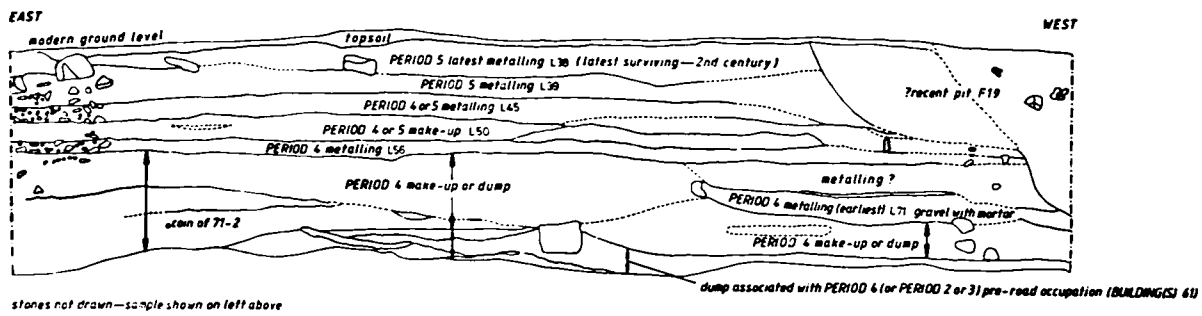
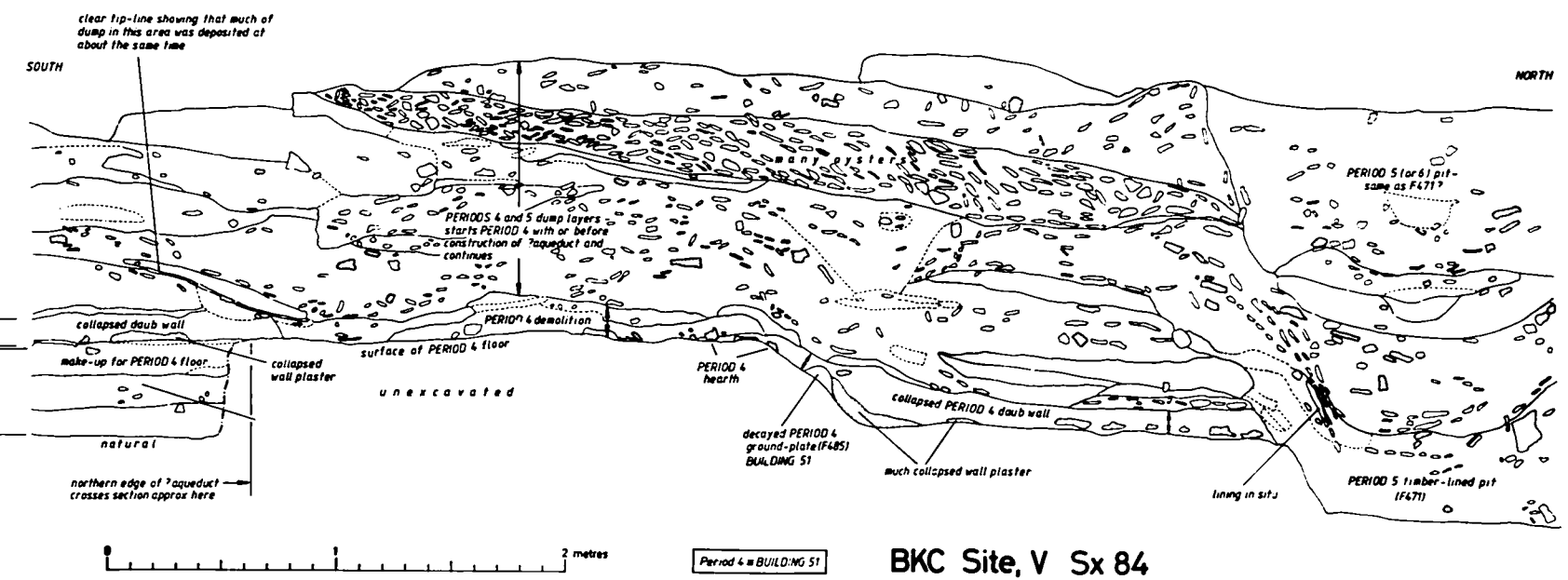
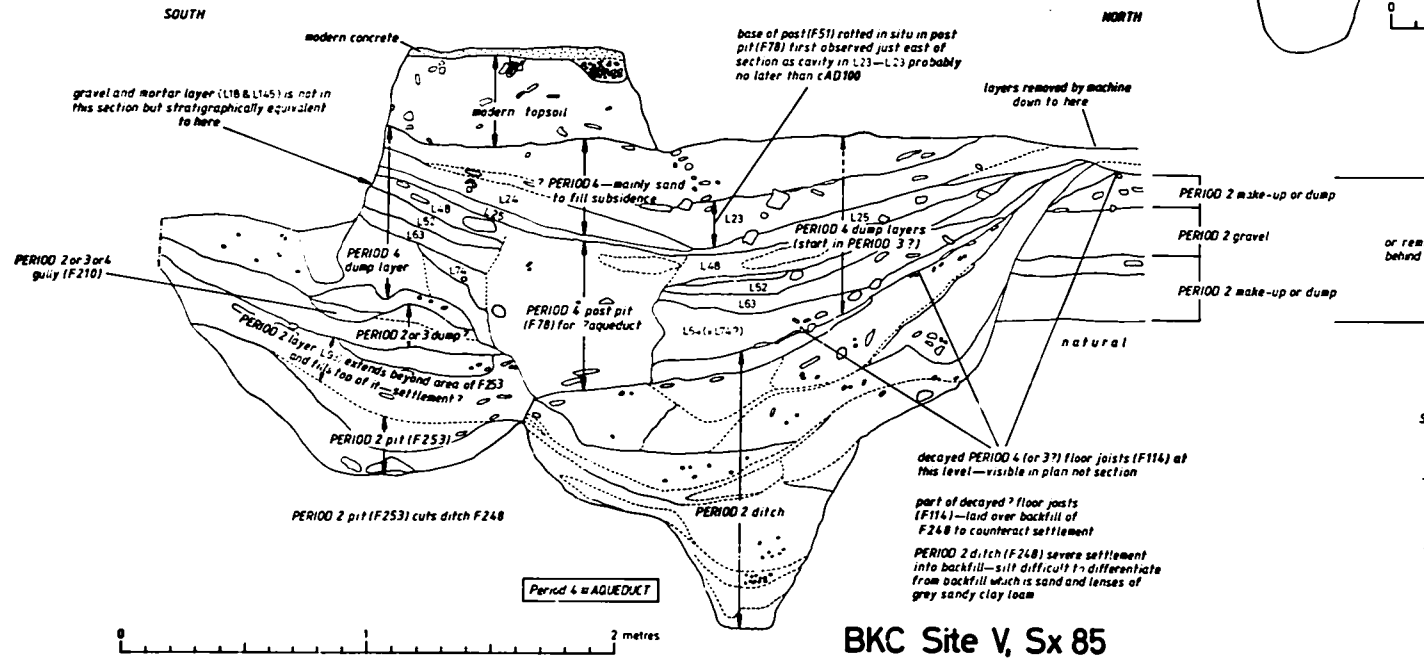
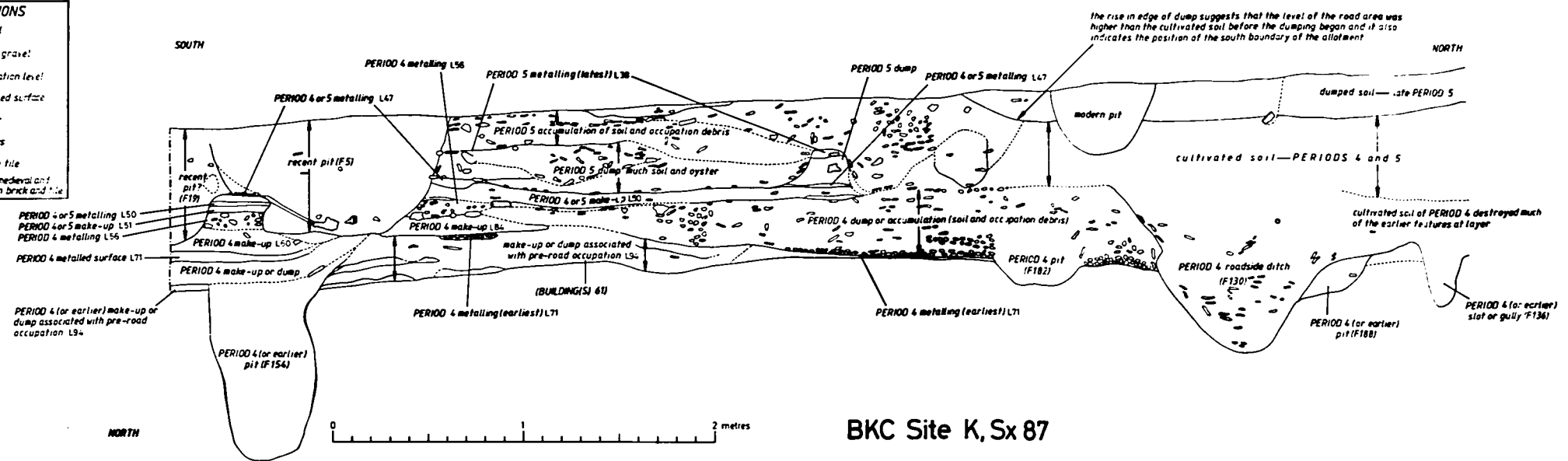


**BKC Site R, Sx 82**

# Sxs 84-88

**KEY FOR SECTIONS**

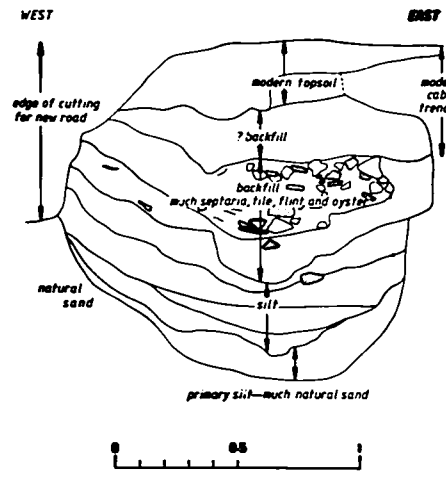
- gravel
- sandy gravel
- occupation level
- scorched surface
- mortar
- oysters
- Roman tile
- post-medieval or modern brick and tile



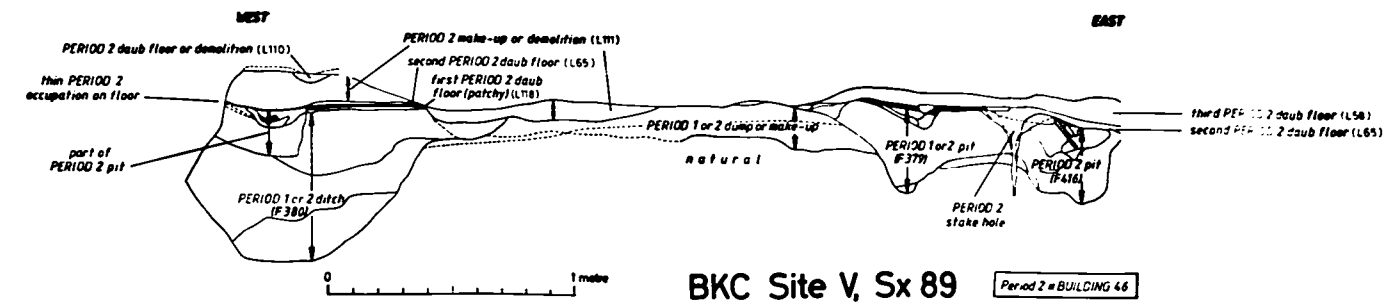
# Sxs 89-97

**KEY FOR SECTIONS**

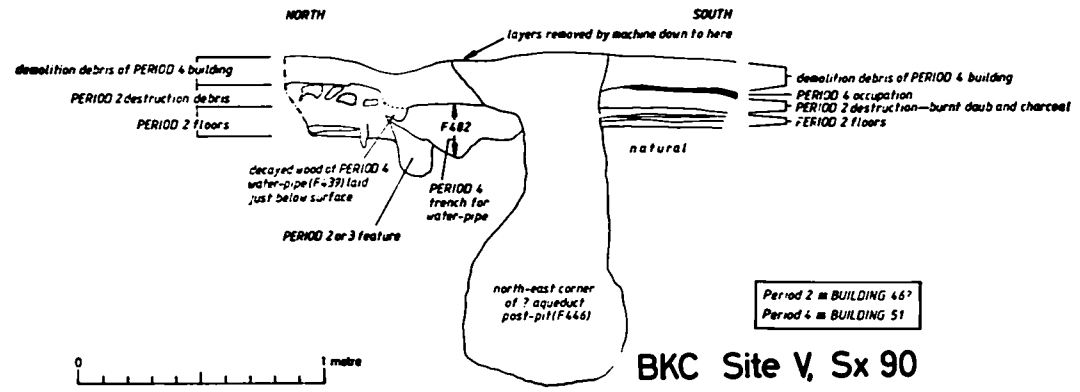
- gravel
- sandy gravel
- occupation level
- scorched surface
- mortar
- oysters
- Roman tile
- post-medieval tile
- modern brick and tile



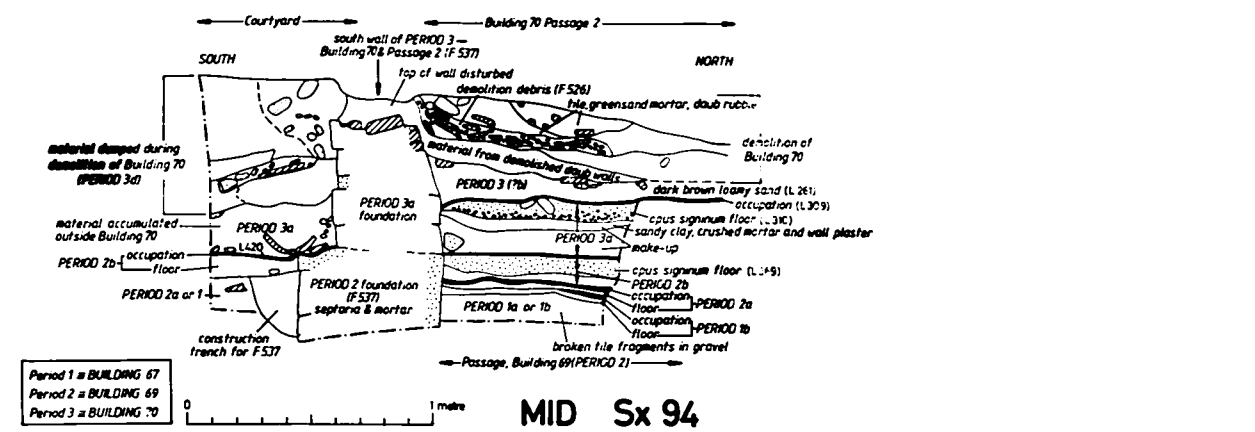
BKC Site U, Sx 91



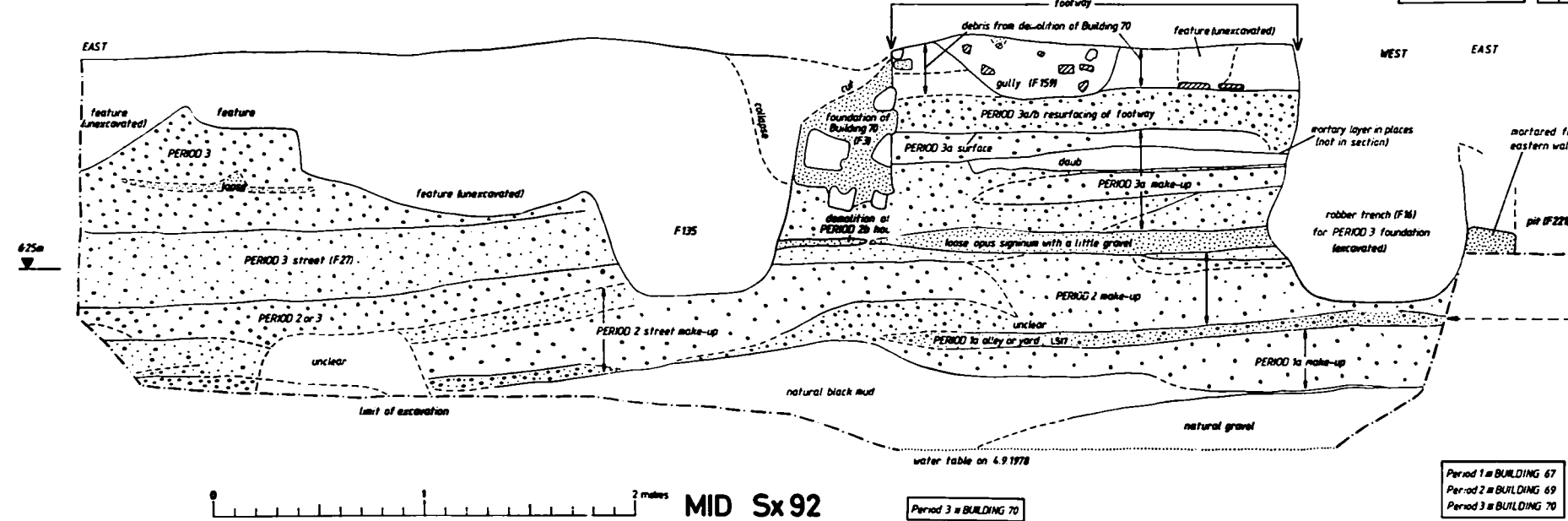
BKC Site V, Sx 89



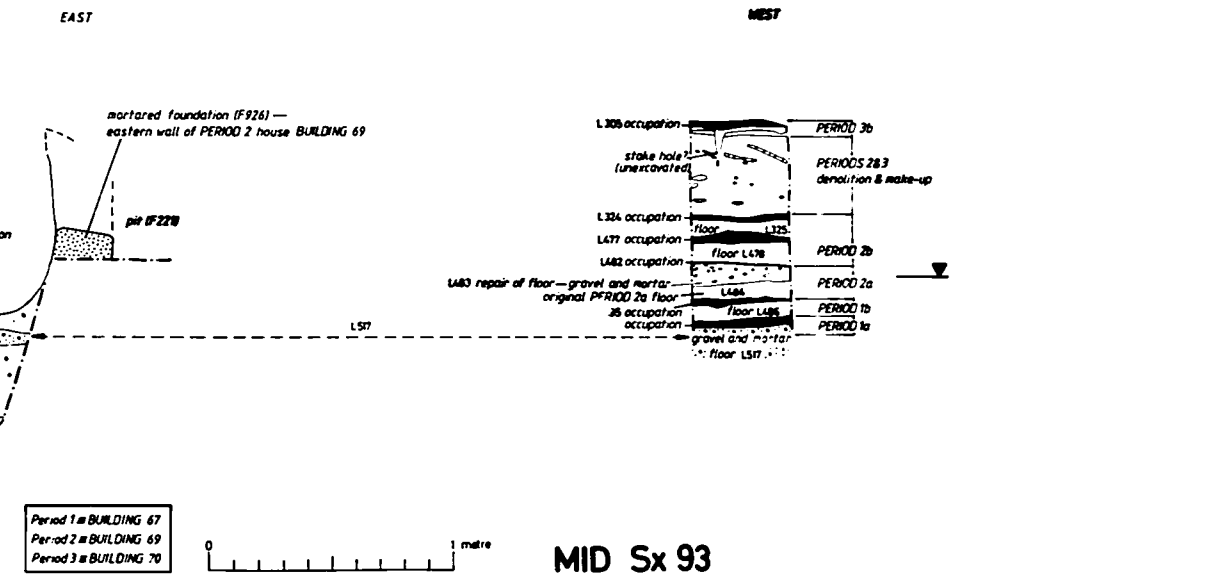
BKC Site V, Sx 90



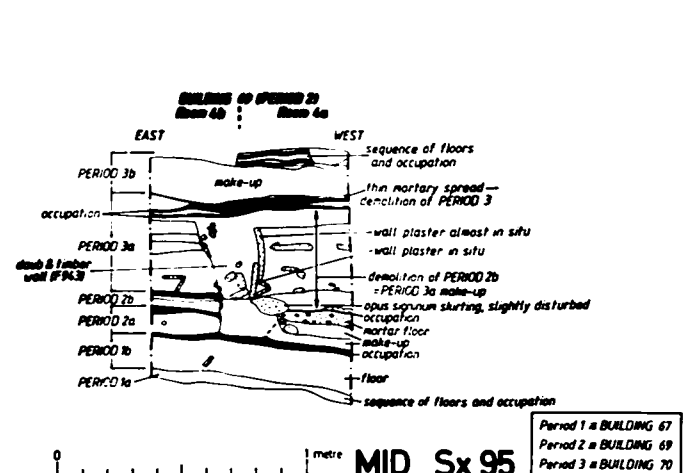
MID Sx 94



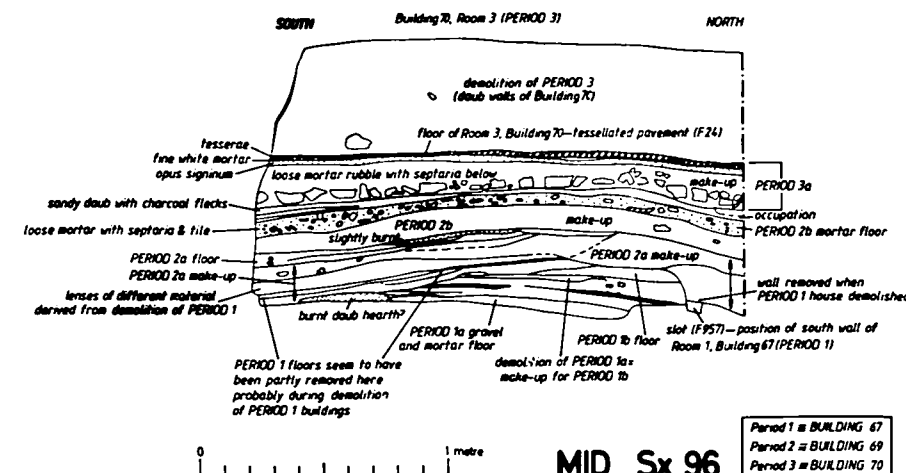
MID Sx 92



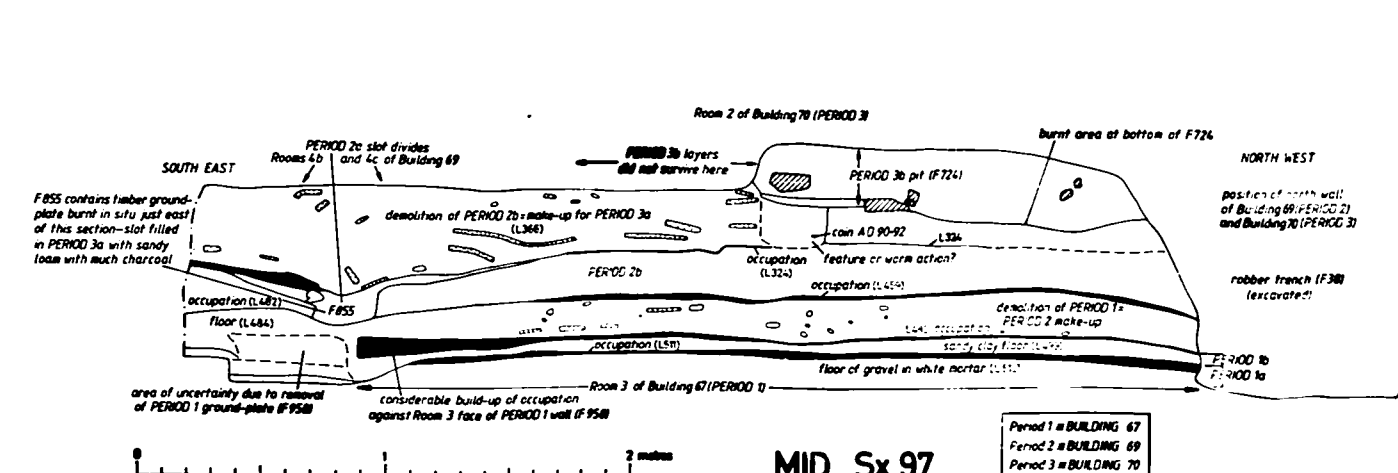
MID Sx 93



MID Sx 95



MID Sx 96



MID Sx 97

# Sxs 100-112

**KEY FOR SECTIONS**

- gravel
- sandy gravel
- occupation level
- scorched surface
- mortar
- cysters
- Roman tile
- post-medieval and modern brick and tile

